

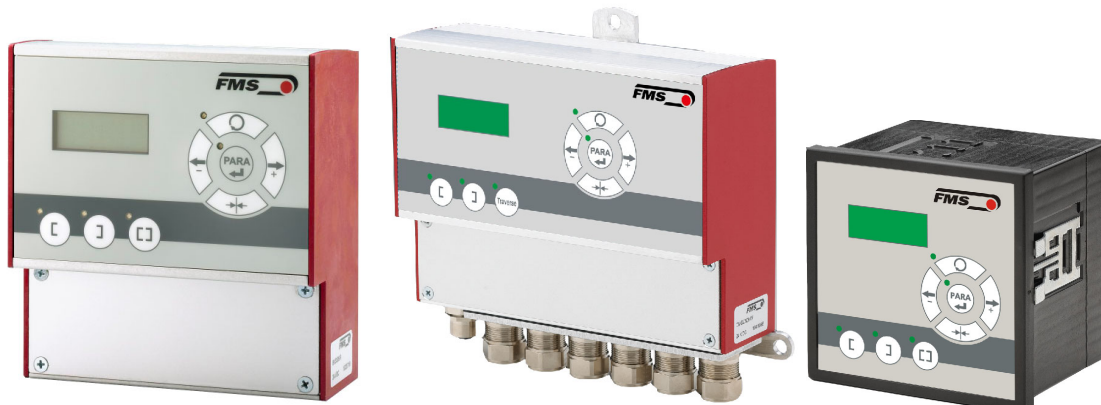

# Operating Manual BKS309.EIP

Digital Web Guide Controller with EtherNet/IP Interface

Version 2.62 03/2021 NS  
Firmware Version: V2.43



**EtherNet/IP™**

## Table of Contents

<b>1</b>	<b>Safety Instructions .....</b>	<b>4</b>
1.1	Description Conditions	4
1.2	List of Safety Instructions	4
<b>2</b>	<b>System Description .....</b>	<b>5</b>
2.1	Functional Description	5
2.2	Steering Frame or Actuator	5
2.3	Electronic Control Unit	5
2.4	Sensors	6
2.5	System Integration in an Ethernet Network	6
<b>3</b>	<b>Quick Installation Guide.....</b>	<b>6</b>
3.1	Preparations for Set-up	6
3.2	Installation Procedure	7
<b>4</b>	<b>Installation .....</b>	<b>8</b>
4.1	Mounting the Steering Frame	8
4.2	Mounting the Actuator to your Unwind or Rewind Station	8
4.3	Mounting the Sensors	8
4.4	Mounting the Electronic Control Unit	9
<b>5</b>	<b>Wiring Diagrams .....</b>	<b>10</b>
5.1	Electrical connection BKS309.EIP.R / .S or .W	10
5.2	Relays Outputs	12
5.3	Digital Inputs	12
5.4	Opening the Housing	<b>Fehler! Textmarke nicht definiert.</b>
<b>6</b>	<b>Configuring the System.....</b>	<b>15</b>
6.1	Power up the BKS 309	15
6.2	Adjustment of the Sensors	15
<b>7</b>	<b>Network Connection over EtherNet/IP .....</b>	<b>16</b>
7.1	EtherNet/IP Specification:	16
7.2	Controller Functionality over EtherNet/IP	16
7.3	Integration of BKS309.EIP in an Ethernet Network	16
7.4	Configuration of the Web Guide Controller over EtherNet/IP	16
<b>8</b>	<b>Integration in an Allen-Bradley PLC .....</b>	<b>18</b>
8.1	Hardware Environment	18
8.2	IP Configuration	18
8.3	Integration in a Project	18
8.4	Access to the Status Information	22
<b>9</b>	<b>Operation .....</b>	<b>23</b>
9.1	Operation Panel	23
9.2	Operating the Web Guiding System via the Front Panel	23
9.3	Automatic Operation	24
9.4	Manual Operation	25
9.5	Saving the Travel Limits	25
<b>10</b>	<b>Parameter Setting over the Front Panel.....</b>	<b>26</b>
10.1	Basic Instructions for Parameter Setting	26

10.2	Setting of Operation Parameters	26
10.3	Setting of System Parameters	26
10.4	List of Operation Parameters	27
10.5	Description of Operation Parameter	28
10.6	Description of System Parameters	39
10.7	Reset to Default Parameter Set	41
<b>11</b>	<b>Parameter Setting via a PC.....</b>	<b>42</b>
11.1	Parameterization in a Network via Web Browser	43
11.2	Parameterization via a PC (peer-to-peer connection)	47
<b>12</b>	<b>Mechanical Dimensions .....</b>	<b>50</b>
<b>13</b>	<b>Trouble Shooting.....</b>	<b>51</b>
<b>14</b>	<b>Technical Specification.....</b>	<b>52</b>

# 1 Safety Instructions

## 1.1 Description Conditions

a) Danger of health injury or loss of life



### **Danger**

*This symbol refers to high risk for persons to get health injury or loss life. It has to be followed strictly.*

b) Risk of damage of machines



### **Caution**

*This symbol refers to information, that, if ignored, could cause heavy mechanical damage. This warning has to be followed absolutely.*

c) Note for proper function



### **Note**

*This symbol refers to an important information about proper use. If not followed, malfunction can be the result.*

## 1.2 List of Safety Instructions



*Some contacts on the power supply board are under 230V tension! Mortal danger! Disconnect power supply before open the housing!*

**⚠** *Proper function of the FMS web guide is only guaranteed with the recommended application of the components. In case of other arrangement, heavy malfunction can be the result.*

**⚠** *Local installation regulations are to preserve safety of electric equipment. They are not taken into consideration by this operating manual. However, they have to be followed strictly.*

**⚠** *Bad earth connection may cause electric shock to persons, malfunction of the total system or damage of the control unit! It is vital to ensure that proper earth connection is done.*

**⚠** *The processor board is mounted directly behind the operation panel. Improper handling of the electronic boards may cause damage to the fragile equipment! Don't use rough tools such as screwdrivers or pliers! Operators handling the electronic boards must wear a well earthed bracelet in order to discharge static electricity*

## 2 System Description

### 2.1 Functional Description

**Figure 1** shows a typical web guiding system with its basic components. The sensors measure the position of the web edge and send this information as an analogue signal to the electronic control unit. In our case a BKS309.EIP web guide controller. The control compares the position feedback signal with the reference. If the difference of these two values is higher than the stored dead band value, the steering frame will be adjusted.

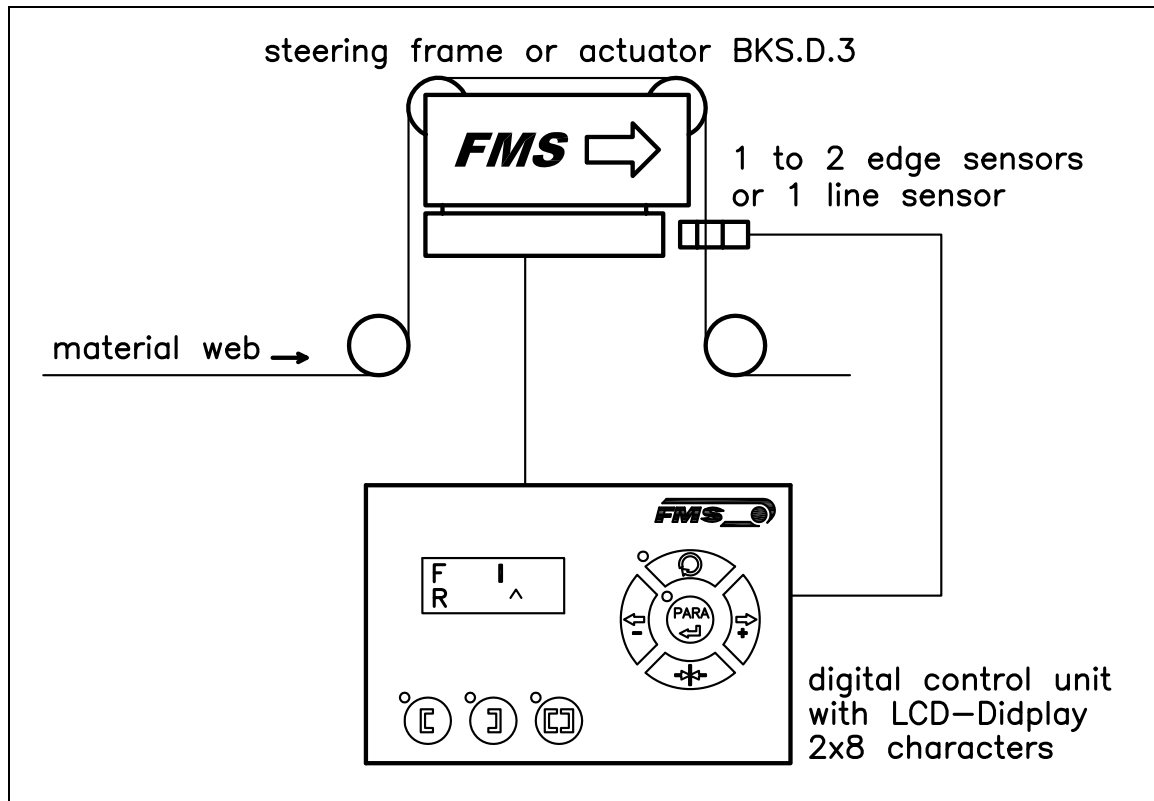

**Fig. 1:** Basic system arrangement with BKS309.EIP web guide controller K309003e

### 2.2 Steering Frame or Actuator

The steering frame consists of a fixed lower and a moveable upper frame that supports the rollers. The upper frame is activated by a stepper motor. The rollers are manufactured and balanced according to customer specification. End positions are controlled via a linear potentiometer. A location rail for easy sensor attachment is integrated to the steering frame. For rewind and unwind stands a stepper motor based drive acts as actuator.

### 2.3 Electronic Control Unit

The micro-processor based electronic control unit handles all calculations and communications. Parameter setting can be performed via the front panel, through a Web Browser or via the EtherNet/IP. All parameters are stored in a non-volatile EEPROM memory. The BKS309.EIP controllers work in combination with FMS

steering frames of the type **webMASTER**, with steering rollers of the type **webDIRECTOR**, and actuators of the type **winderGLIDE**.

## 2.4 Sensors

Optical sensors (**AZS01/04**), ultrasonic sensors (**US01/4B**) and a digital line sensor (**DLS**) are available from FMS. These sensors provide a signal of 0...10V. With them, edge, center and line guiding applications can be covered.

 **Note**  
*If you retrofit a DLS2 sensor to an existing controller you have to restart the controller after the installation of the sensor. This will allow the controller to detect the DLS2 sensor correctly.*

## 2.5 System Integration in an Ethernet Network

The web guide controller BKS309.EIP offers in addition to his standard features the possibility to be used as an EtherNet/IP device in a corresponding network. EtherNet/IP bases on the Ethernet TCP/IP and the UDP technology as well as on the CIP (Common Industrial Protocol). The web guide controller can be embedded in a standard Ethernet infrastructure. Its fast data rate with cycle times down to 2ms makes the device ideal for applications in automated assembly and production lines. Configuration of the web guide controller takes place either over the EtherNet/IP, a web browser or over the operating panel.

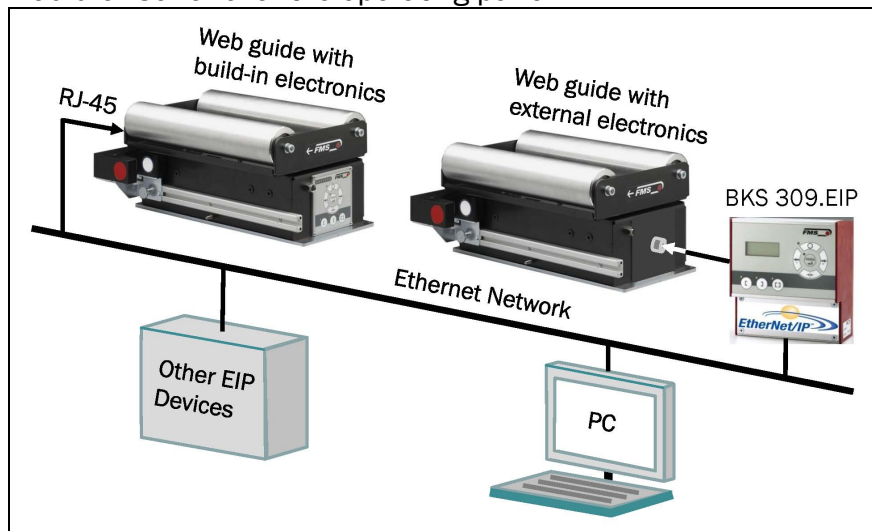

Fig. 2: BKS309.EIP in an Ethernet Network

K309EIP001e

## 3 Quick Installation Guide

In a Plug & Play configuration the set-up of the BKS309.EIP controller and corresponding guiding unit is limited to only mounting the devices on the machine frame, wiring and powering up system.

### 3.1 Preparations for Set-up

1. Read the Operation Manual of your web guide or actuator system.

2. Check your system requirements such as:
  - Desired guiding form (edge, centre or line guiding)
  - Unit system (metric, imperial)
  - Relay or digital input requirements of your set-up
3. Draw the wiring diagram for your configuration (ref. to chapter **5.1** to **5.6**)
4. If required, determine special parameters (ref. to **10** "Parameter Setting over the Front Panel")

## 3.2 Installation Procedure

1. Mount and adjust your material sensor(s) to the steering frame (ref. to chapter **4.3**)
2. Mount the steering frame or actuator to the machine
3. Wire the sensor(s) to the electronic unit (ref. to chapter **5**)
4. Wire the steering frame to the electronic unit (ref. to chapter **5.1** to **5.6**)
5. Mount the electronic unit on a place where it can be easily reached by the operator
6. Make sure the power supply voltage is in the range 18 to 30V DC ( $V_{nom} = 24V$ )
7. Integrate web guide controller in an Ethernet network and PLC (see chapters **7.3** and **8**)
8. If required, make additional settings (ref. to **10.2** "Setting of Operation Parameters")

## 4 Installation



### **Caution**

*Proper function of the FMS web guides and actuators is only guaranteed with the recommended application of the components. Other arrangements, can cause heavy malfunctions. Therefore, the installation instructions on the following pages must strictly be followed.*



### **Caution**

*Local installation regulations are to preserve safety of electric equipment. They are not taken into consideration by this operating manual. However, they have to be followed strictly.*

### 4.1 Mounting the Steering Frame

The mounting orientation of the steering frame (indicated by an arrow), must correspond with the web running direction. The lower frame is mounted with four M8 screws to the machine frame. The machine must be prepared to accept the M8 mounting screws.

### 4.2 Mounting the Actuator to your Unwind or Rewind Station

To provide the optimum function of the actuator you should mount it in a horizontal position. Attach the housing of the actuator to the machine frame. Bolt the moving part (connection rod) to the winding roll.

Different connectors (fork head, yoke, etc.) are available from the FMS accessories program.

Dimensions can be taken from the data sheet..

### 4.3 Mounting the Sensors

The sensors will be mounted with brackets to the rail of the steering frame or to the sensor arrangement of the unwind/rewind stand (refer to operation manual AZS01, US01 or DLS).

The sensors have to be installed after the steering frame if seen in running direction of the web. They have to be mounted so that the narrow side is closer to the steering frame (see **Fig. 2**).



**Definition of Left and Right:**

Left and right are always seen in direction of the running web (see Fig. 3).

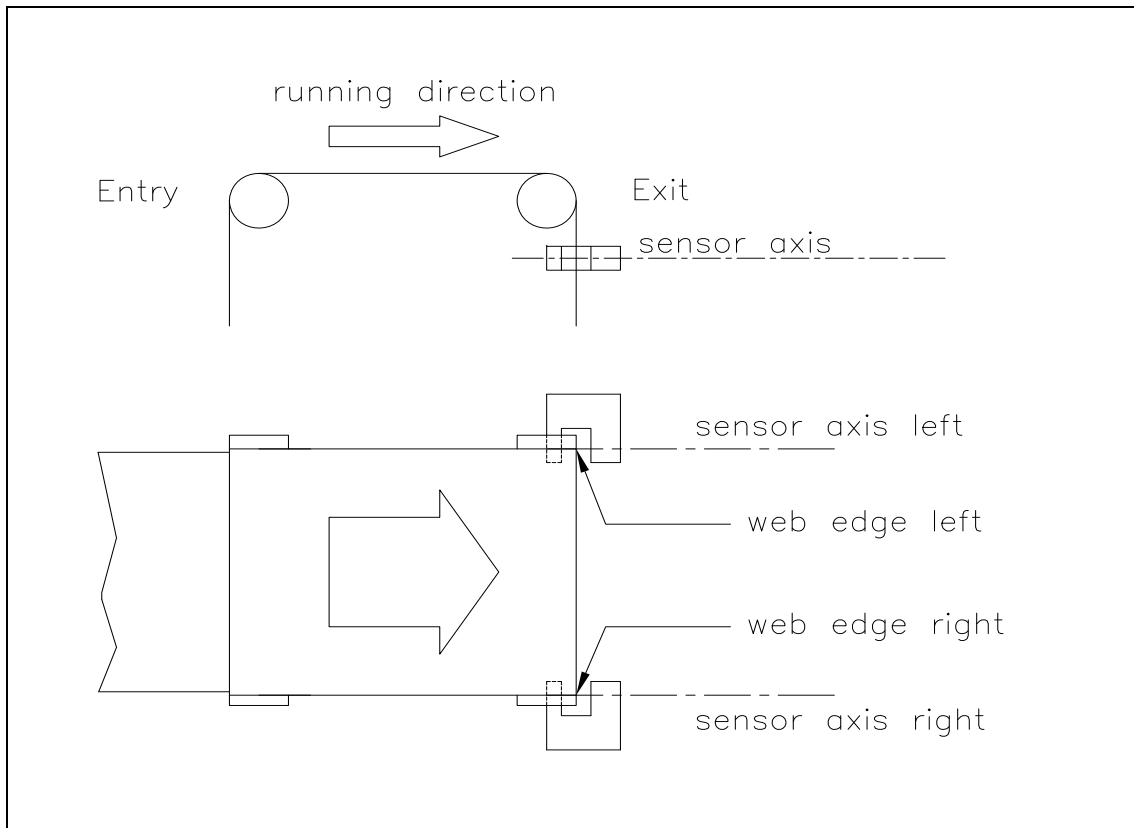

Fig. 3: Position of the sensors according to the web

K400005e

**Note**

*Make sure that the sensor(s) are connected properly to the electronic unit by means of the delivered cables. For left / right orientation please refer to Fig. 3. If the connections are crossed over, malfunction can be the result.*

**Note**

*For optimum control results, the sensors have to be placed next to the exit roller of the steering frame. If the sensors are placed far from the steering frame, control dynamics will deteriorate.*

## 4.4 Mounting the Electronic Control Unit

The BKS309.EIP series is available in four different housing options:

1. Rail mount housing (electrical connections via screw terminals)
2. Rail mount housing (electrical connections via connectors)
3. Wall mount housing
4. Panel mount housing (stand alone and build-in in steering frame)

The mechanical dimensions can be seen in chapter **12** "Mechanical Dimensions".

## 5 Wiring Diagrams

Use the original FMS cables to connect the steering frame respectively the actuator to the BKS309.EIP controller. The connector end of the cable is connected either to a steering frame or a BKS.D.3 / D.6 actuator. The open ends of the cables must be wired to the cable terminals in the controller according to the wiring diagrams below (ref. also to Fig. 4)

### 5.1 Electrical connection BKS309.EIP.R / .S or .W

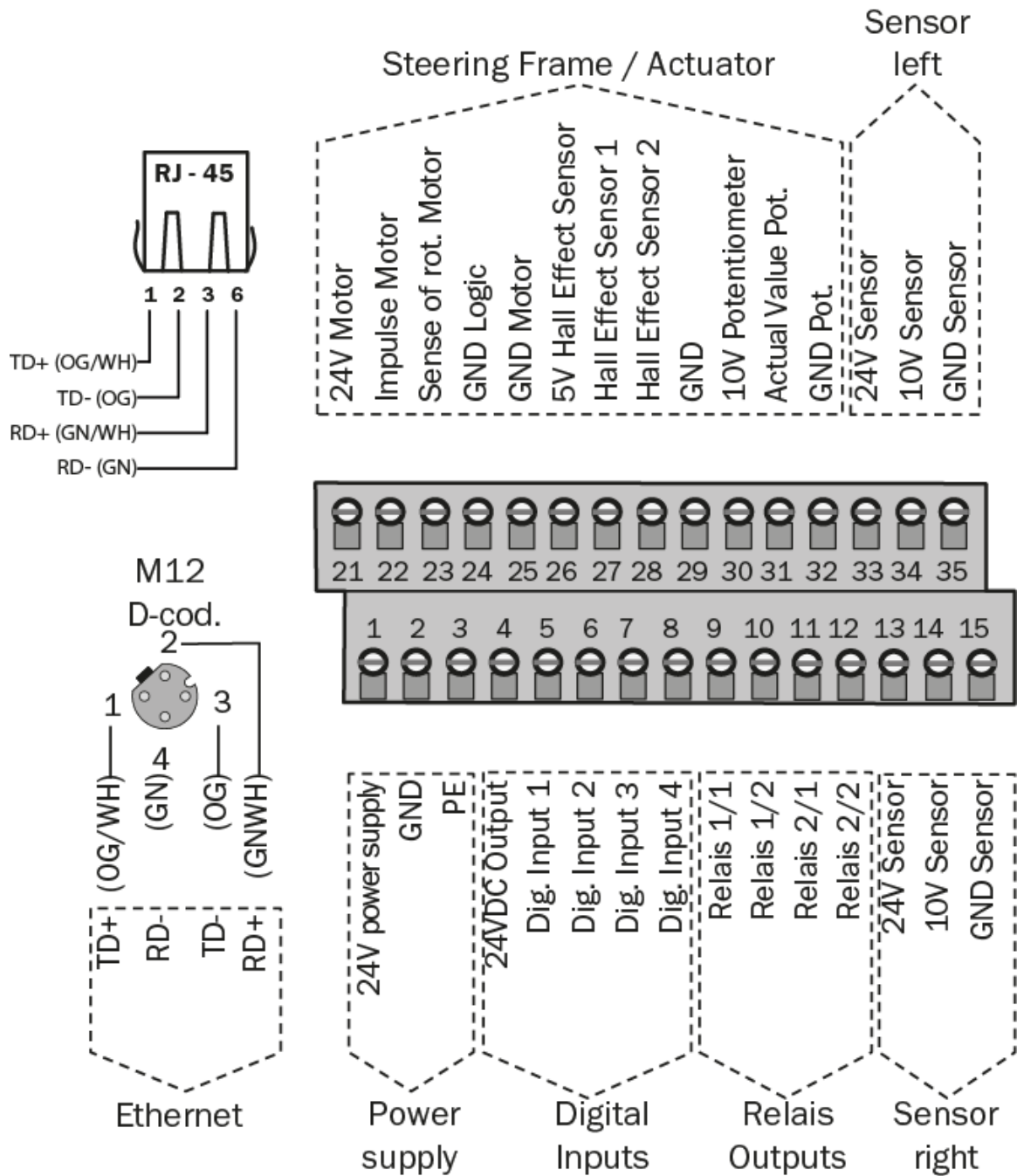

Fig. 4: Electrical connections BKS309.EIP BKS\_309.ai

### 5.1.1 Connecting the material sensors

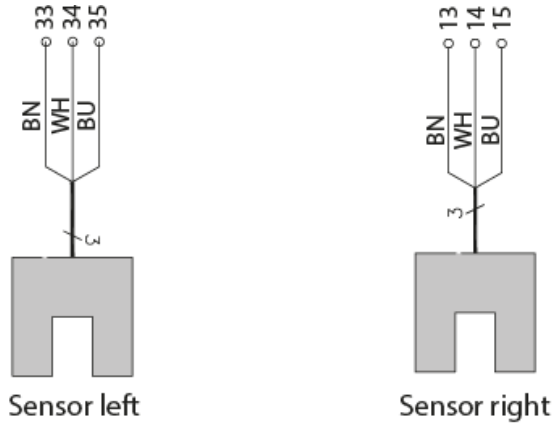

Fig 5: BKS\_309.ai

### 5.1.2 Connecting steering frames FMS webMASTER BKS020, BKS015

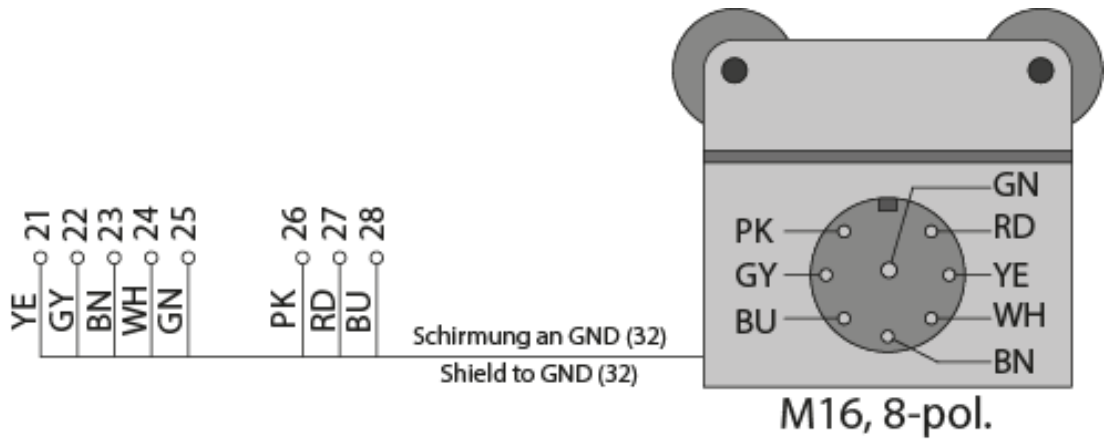

Fig 6: BKS\_309.ai

### 5.1.3 Connecting FMS winderGLIDEs BKS.D.3, BKS.D.4 or a steering frame FMS webMASTER BKS030

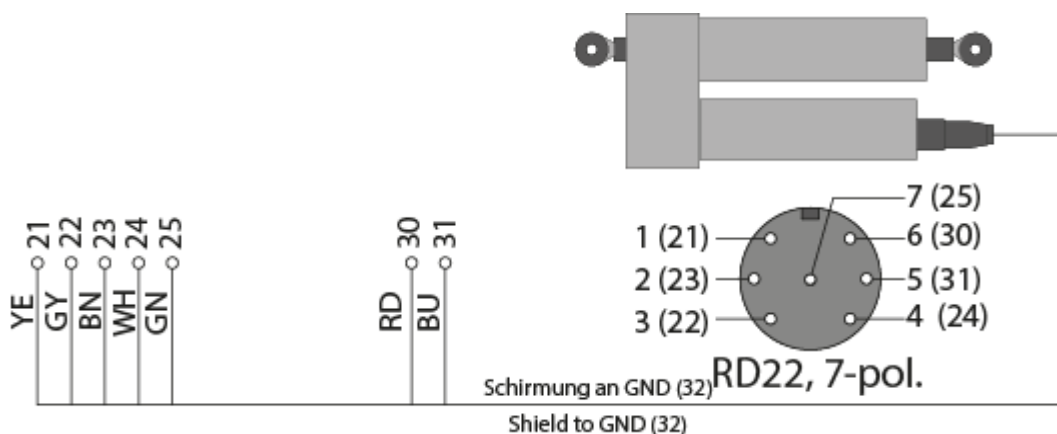

Fig 7: Pin assignment of FMS winderGLIDEs BKS.D.3 and BKS.D.4 and terminal blocks of controller. The illustration shows a BKS.D.3 or BKS.D.4. The wiring of the BKS030 is similar. BKS309\_BA\_Manual.ai

### 5.1.4 Connecting an actuator BKS.D.6

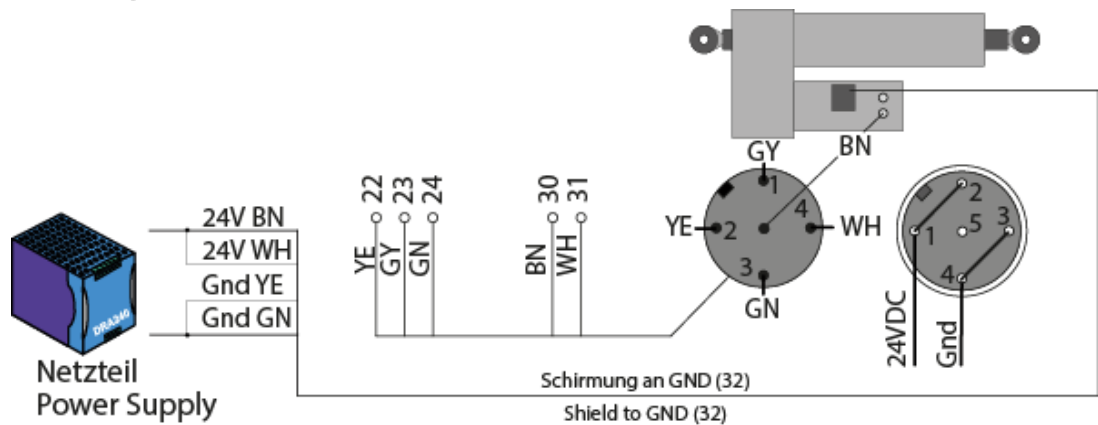

Fig 8: BKS\_309.ai

## 5.2 Relays Outputs

The BKS309.EIP controller provides 2 programmable relay outputs. The outputs are software controlled. Electrically they are potential-free. Each relay output can be configured individually and can perform an assign special function. The outputs are configured in the Parameter Setting Mode. Following functions can be assigned to each output:

- Indicate centre position of web
- Indicated if web is loaded (material is present)
- Indicate if web is loaded and Automatic Mode on
- Indicate if no web is loaded and Automatic Mode on
- Indicate if Automatic Mode was chosen
- Indicate if steering frame or actuator is centred

For more details about the functions refer to chapter 10.5 “Description Operation Parameter”.

Hardware access via screw terminals (see Fig. 9)

Signal Name	Terminal #
Relay 1/1	9
Relay 1/2	10
Relay 2/1	11
Relay 2/2	12

## 5.3 Digital Inputs

The BKS309.EIP controller provides 4 digital inputs for special functions. The digital inputs are edge or level triggered. An impulse of 100ms or longer activates the event. Each digital input can be configured individually and can perform an assign special function. The digital inputs are configured in the Parameter Setting Mode. Following function can be assign to each digital input:

- Toggle between Manual and Automatic mode (edge triggered)
- Toggle between Manual and Automatic mode (level triggered)
- Go to centre position
- Decrease reference value in 0.1mm steps (automatic mode) or move actuator in 0.1mm steps to the left

- Increase reference value in 0.1mm steps or move actuator in 0.1mm steps to the right
- Lock steering device (steering frame or actuator)
- Reset reference value

For more details about the functions refer to chapter 10.5 “Description Operation Parameter”.



**Caution**

*If the function "Toggle between Manual and Automatic mode" is controlled via the digital inputs, the corresponding key  on the operation panel will be deactivated.*

Hardware access via screw terminals (see Fig. 9)

Signal Name	Terminal #
Dig.In 1	5
Dig.In 2	6
Dig.In 3	7
Dig.In 4	8



**Caution**

*Bad earth connections may cause electric shocks to persons, malfunction of the total system or damage of the control unit! It is vital to ensure that the earth connection is properly done.*

## 6 Configuring the System

After having mounted and wired the web guiding equipment on the machine, the system can now be configured to the specific requirements of the application.

### 6.1 Power up the BKS 309

1. Make sure the power supply voltage is in the range 18...30 VDC ( $V_{nom} = 24V$ )
2. Check, if the web is in the detection range of the sensors.
3. Switch-on your power supply
4. The web guide or actuator starts-up in Manual Operating Mode.

### 6.2 Adjustment of the Sensors

Align sensor axis to the web edge: Loosen the fixing nut on the bracket and adjust the sensor. Fix the sensor in the new position. The sensor will be positioned properly if the web edge goes through the sensor axis (center of active window (ref. to **Fig. 10**)).

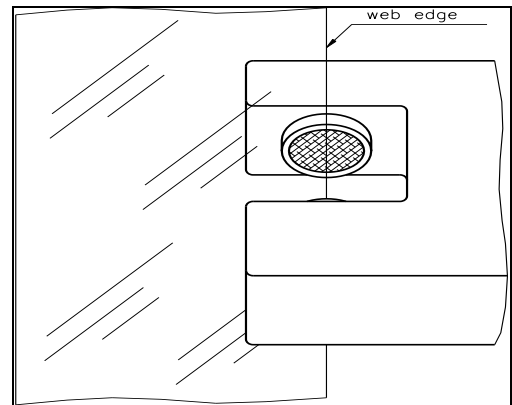

**Fig 10:** Alignment of the sensor axis to the web edge K100004e

## 7 Network Connection over EtherNet/IP

The web guide controller BKS309.EIP is able to communicate with other devices over an Ethernet network. CIP (Common Industrial Protocol) is used as the protocol for the data link. The controller acts as a so called “Producer” and the machine control (or PLC) as the “Consumer”.

### 7.1 EtherNet/IP Specification:

Physical layer: Ethernet IEEE 802.3.

Transport protocol: TCP/IP und UDP

Standard: CIP IEC 61158

Conformity: CPF 2 (Communication Profile Family 2) IEC 61784-1

### 7.2 Controller Functionality over EtherNet/IP

Basically, all functions for configuration and calibration can be performed over EtherNet/IP. Furthermore, status information of the controller can be cyclically propagated over the network and made available to the Consumer (PLC).

### 7.3 Integration of BKS309.EIP in an Ethernet Network

In order to integrate the web guide controller in an Ethernet network and enable data transfer over it following conditions must be fulfilled:

- ✓ An BKS309 controller with the option EtherNet/IP (EIP) must be used.
- ✓ The IP-Address must be assigned in the fix address block and must be unambiguously. It may only exist once in the network.
- ✓ The network mask must correspond with the used device configuration.

If these prerequisites are given, the controller will recognise the amplifier as an EtherNet/IP device in the network and be able to communicate with it. The interface information for BKS309.EIP is defined in an EDS-file. The EDS file is only used as documentation and cannot be imported into RSLogix 5000.

EDS-files for BKS309.\_. EIP can be downloaded from the FMS webpage.



#### **Note**

*The device does not support the import of the EDS files. The import with development software e.g. RSLogix5000 will generate error messages.*

*Utilize “Messages” to change parameter values of the device. Details are explained in the sample file which is available for download on the FMS website.*

### 7.4 Configuration of the Web Guide Controller over EtherNet/IP

BKS309.EIP may, but need not be configured via EtherNet/IP. It can be configured by means of a machine control unit. This unit is integrated in the same network. The communication between machine control and web guide controller is carried out with



dedicated software (e.g. RSLogix5000 from Rockwell). Please refer to the operating manual of the respective machine controller.

There are three possibilities to configure the BKS309.EIP. If the method over EtherNet/IP is selected, the other two options (operation panel or web interface) are still possible but not meaningful. The EtherNet/IP method has then always priority and overwrites any other configurations set by the other two methods.

If the configuration over EtherNet/IP is selected then messages from the PLC to the BKS309 must be used.

How the messages are used is described in the example project.

The example project BKS309\_BKS015\_EIP\_Example\_Project\_Vx.xx is available for download on the FMS website.



### **Note**

*The configuration of the web guide controller via EtherNet/IP must be used as commissioning procedure. Continuously writing parameters on a cyclic base is not allowed and will lead to communication problems and reduced the lifetime of the device.*

## 8 Integration in an Allen-Bradley PLC

Following chapters deal with the integration and operation of the BKS309.EIP controller with an Allen-Bradley PLC. The project software RSLogix5000 from Allen-Bradley is required to program the PLC. Furthermore, it is assumed that a development system with PC and corresponding development software RSLogix from Rockwell Automation is available and the programmer is familiar with these tools..

### 8.1 Hardware Environment

The BKS309.EIP must be connected to an Ethernet switch which in turn is in the same network as the PLC. Only in this way a communication between BKS309.EIP and PLC can take place. Several BKS309.EIP or other ErtherNet/IP devices can be connected to the same network.

### 8.2 IP Configuration

In an industrial environment, the IP addresses are normally assigned fix to the EIP devices. This holds also for the BKS309.EIP controller that needs a fix IP address in the network. The IP address configuration must take place before the BKS309.EIP is integrated in a network. This is done over the operation panel or over the web interface.

The procedures are described in the state diagrams **chapter 10 (Fig. 22)** and **chapter 11 (Fig.31)**

### 8.3 Integration in a Project

Before starting the development system RSLogix5000 the PLC and BKS309.EIP need to be connected to the network and powered-up. Now a new project or an existing project can be opened in RSLogix5000. Search in the tree structure *Controller Organizer* for the listing **Ethernet** and make a right mouse click (see **Fig. 11**).

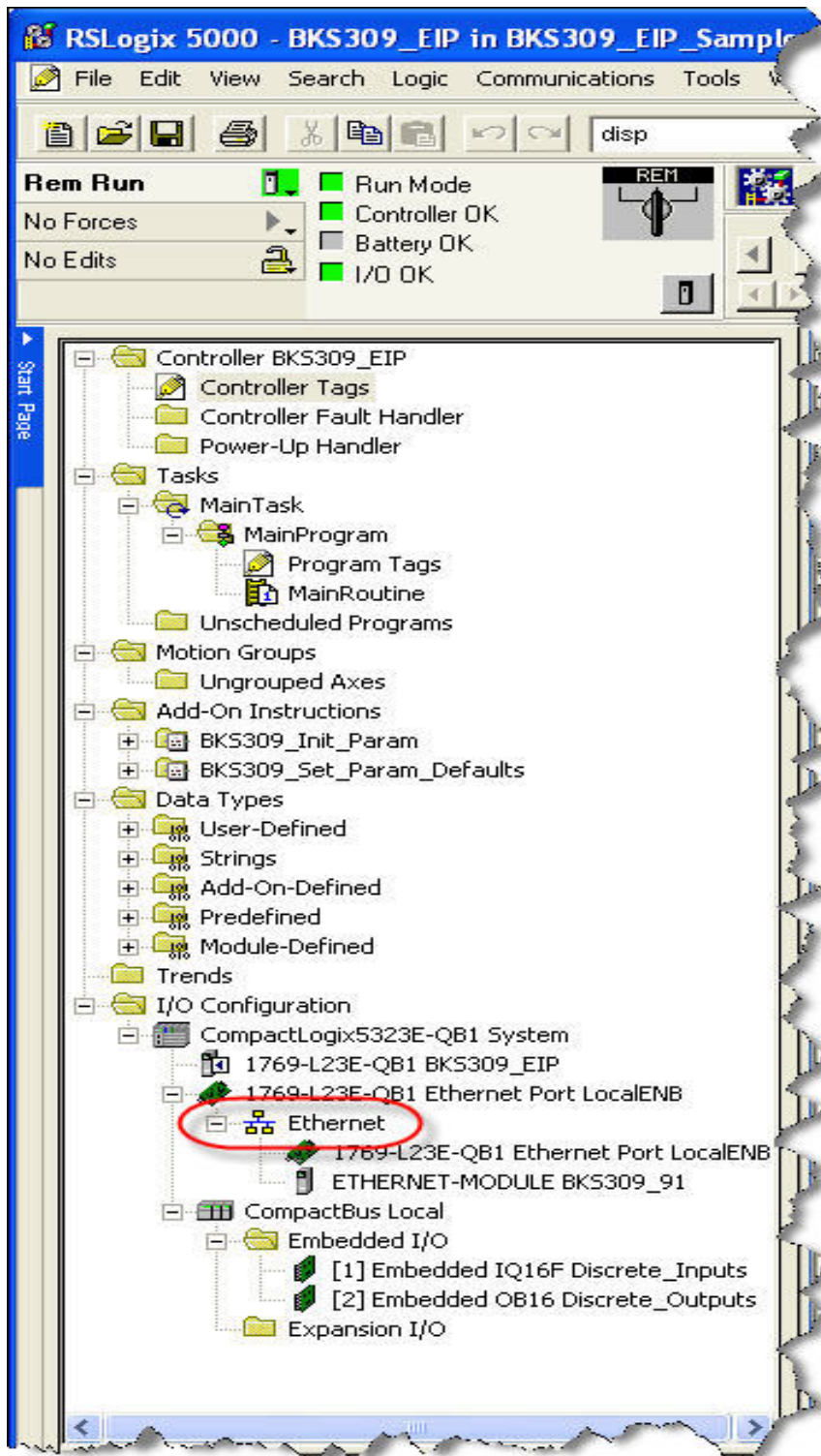

Fig. 11: Controller Organization

K309EIP02

In this example CompactLogixL23E-QB1B is used. If a different hardware is used, one may find the listing *Ethernet* in another place. However, the principal approach is always the same. After a right mouse click on *Ethernet* a dialog window will open up. Left mouse click on *New Module...* and a new window will open up (see Fig.12).

Open plus-sign [+] in front of **Communications** to see all the other listings.

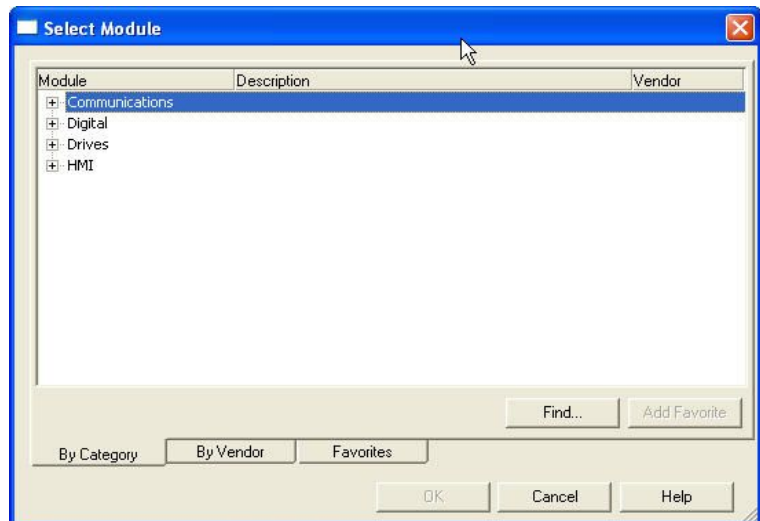

Fig. 12: Module Selection E309023

Select **ETHERNET-MODULE Generic Ethernet Module** and confirm with OK.

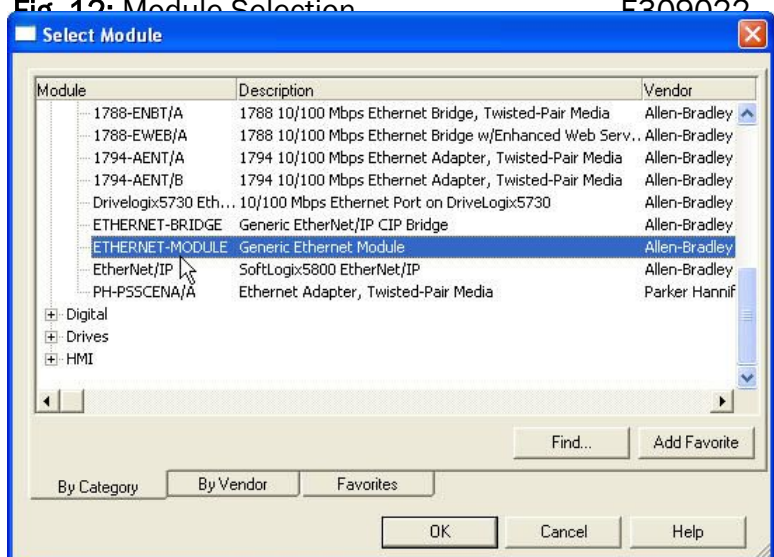

Fig. 13: : Module Selection open E309023

Following window opens up in which the **Name BKS309\_91**, the **Comm Format Input Data - DINT** and the **IP Address** (eg. **192.168.0.91**) need to be entered. On the Connection Parameters side the values **Input=100** with **Size 2**, **Output= 101** (leave empty) and **Configuration= 102** with **Size 88** must be entered. Confirm with **OK**

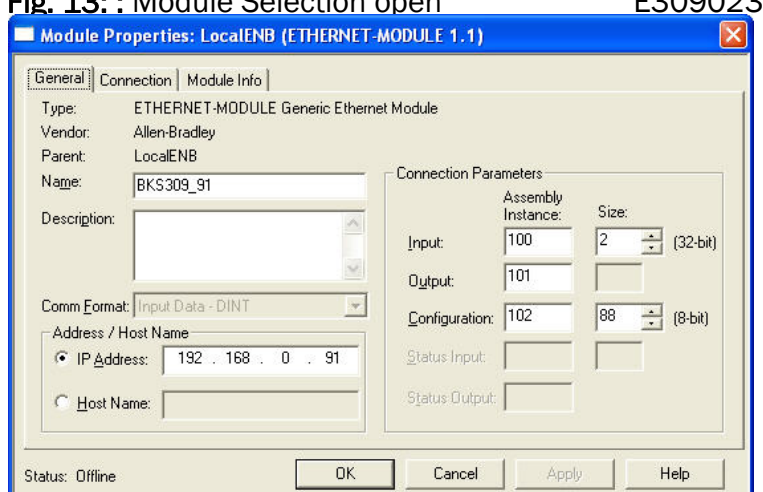

Fig. 14: New Module K309EIP03

The dialog window (Fig. 15) will open up. Here, one can enter the cycle time. This determines how often the data will be propagated in the network. The minimal cycle time is 2ms. Default setting is 10ms. Basically, the cycle time must be set so that the maximum speed requirements of the system are fulfilled. A fast cycle time leads to more data traffic in the network. That can create communication bottlenecks. Especially when using several BKS309 and other EIP devices in the same network a well-balanced data speed is important.

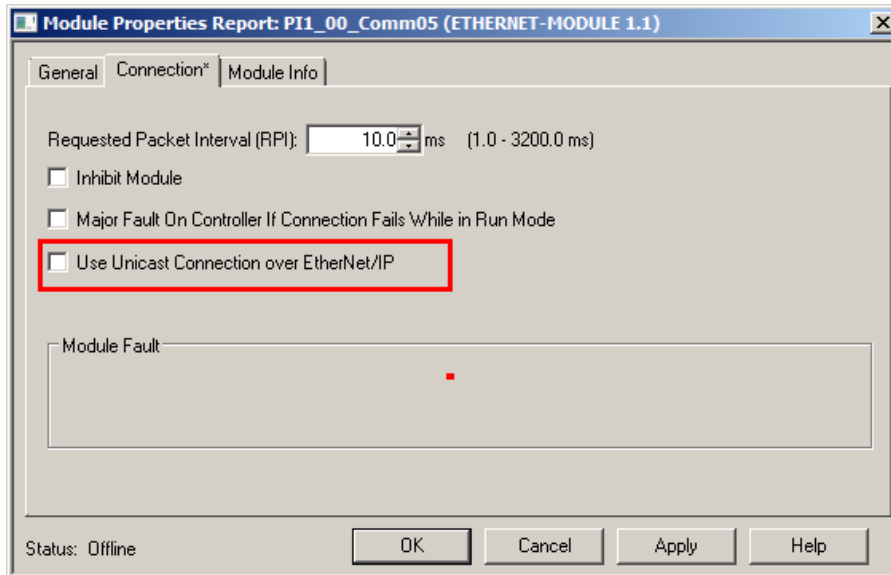

Fig. 15: Module Properties



### Note

*Untick the box „Use Unicast Connection over EtherNet/IP“. The use of this option feature is not allowed because as it will cause communication problems.*

## 8.4 Access to the Status Information

After the integration of the BKS309.EIP in the network the status information are available in the global input tags of the controller and that in the defined cycle time. In our example, our EIP device was named **BKS309**. Operation Status information can therefore be found under the controller tags **BKS309:I >> BKS309:I**

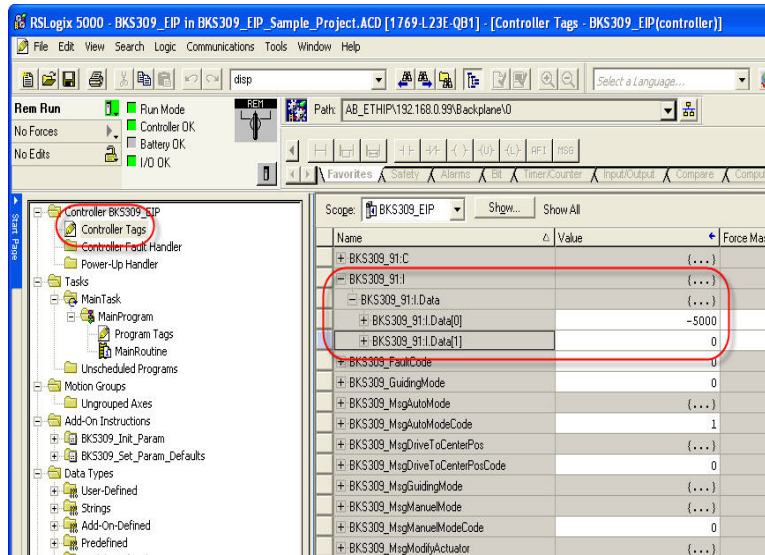

Fig. 16: RSLogix

K309EIP04

### Data [0]

Value from sensor(s) indicating position of web edge in configured unit.

### Data [1]

The data show in what operational state the device currently is.

A PLC can analyse the states and execute further actions.

- Bit 0 set: Automatic Operation switched on
- Bit 1 set: Relay 1 switched on
- Bit 2 set: Relay 2 switched on
- Bit 3 set: Web Guide or winderGLIDE actuator locked
- Bit 4 set: Web Guide or winderGLIDE actuator was driven to the center
- Bit 5 and Bit 6 are not set: Left edge guiding
- Bit 5 set and Bit 6 not set: Right edge guiding
- Bit 5 and Bit 6 are set: Centre guiding

# 9 Operation

## 9.1 Operation Panel

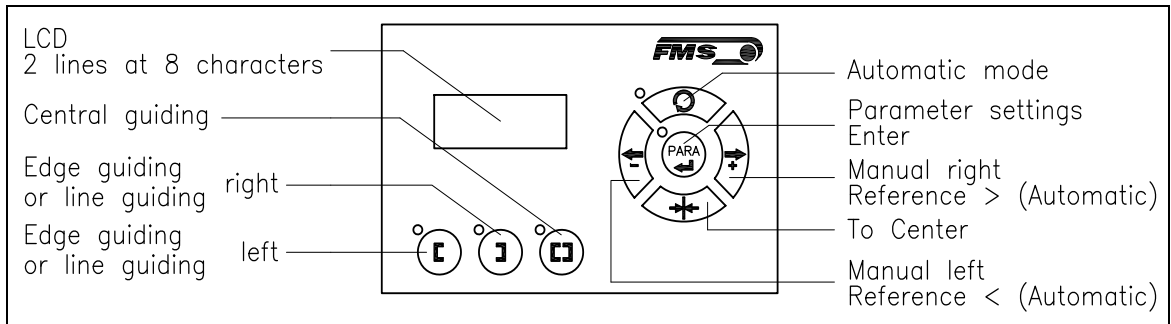





Fig. 17: View of the Operation Panel

K309005e







## 9.2 Operating the Web Guiding System via the Front Panel

Key	Key function during operation
	The sensor is mounted on the left side of the frame and controls the material on the left edge or on the line, if a line sensor is used. One sensor is necessary. The LED indicates the left edge guiding mode.
	The sensor is mounted on the right side of the frame and controls the material on right edge or on the line, if a line sensor is used. One sensor is necessary. The LED indicates the right edge guiding mode.
	Two sensors are mounted on both sides of the frame. The frame is controlled in a way that the material position is kept centered with regard to both sensors position. The LED indicates the centre guiding mode.
	To enter the Parameter Setting Mode, hold the key for longer than 3 sec. The LED will light and the first parameter will appear on the LCD display indicating that you entered the mode. A second press on the PARA key will cause the parameter to flash. Now it can be changed (ref. to 6 "Parameter Setting over the Front Panel")
	Automatic, Manual. With this key you can select between automatic and manual mode. The LED indicates the automatic mode.
	Drive to center position. The frame moves to the center Position. Function is only available in manual mode.

	<p><b>In manual mode</b> the frame will move to the left in 0.1mm steps by pressing the button once. By pressing the button longer than 1 sec. it will continuously move the frame to the left.</p> <p><b>In automatic mode</b> the frame set-point will be adjusted to the left in 0.1 mm steps by pressing the button once. Pressing the button longer than 1 sec. it will continuously move the set-point of the frame to the left.</p> <p><b>In Setup-Position</b> and independent if the device is in manual or</p>
	<p><b>In manual mode</b> the frame will move to the right in 0.1mm steps by pressing the button once. By pressing the button longer than 1 sec. it will continuously move the frame to the right.</p> <p><b>In automatic mode</b> the frame set-point will be adjusted to the right in 0.1 mm steps by pressing the button once. Pressing the button longer than 1 sec. it will continuously move the set-point of the frame to the right.</p> <p><b>In Setup-Position</b> and independent if the device is in manual or automatic mode, pressing the button increases continuously the parameter value.</p>

 **Note**  
*If DLS (digital line sensors) are used, it may happen that the web guide controller blocks the steering frame. This protective function is activated when the line is interrupted and impossible to detect the line anymore. The LED above the  .key will start blinking and indicate to operator that the line quality is bad.*

### 9.3 Automatic Operation

- Start automatic mode with  key or digital input. Reference position is taken from the middle of the sensor detection band (**Fig. 18**). Using center guide, reference position is in the middle between the 2 sensor axis. The controller starts to guide the web to reference position and to hold this guide point.
- The reference position can be adjusted during automatic operation by using the   keys or using digital inputs (step width 0.1 mm). Using the  key, the web moves out of the sensor; using the  key, the web moves in.
- Using center guide, this description refers to the right sensor.
- Terminate the automatic mode by using the  key again.

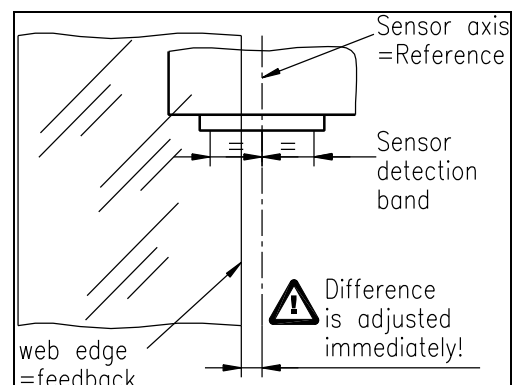

**Fig. 18:** Position at automatic start K  
100005e



**Note**



*If the web leaves the sensor detection band, control is no longer effective. Hold the web edge strictly inside the sensor detection band.*

**Note**

*If web is not running, it can't be guided properly to the reference position! The steering frame moves in the limit-of-travel position and may damage the web. Start automatic mode only when web is slowly running.*









## 9.4 Manual Operation

In manual mode, possibilities as follows are available:

- *Center position*  : The steering frame will return to center position.
- *Frame position*  and  : The steering frame can be adjusted in 0.1mm steps. If key is held, steering frame is moving continuously. These functions can also be carried out via the digital inputs (see 5.7 “Digital Inputs”).

## 9.5 Saving the Travel Limits

There are two possibilities to alter the limits for the Home Position, Middle Position and Maximum Positions of the actuator. Either you modify the parameters [**Home Pos**], [**Mid Pos**] and [**Max Pos**] in the parameter changing mode or you drive manually to the desired position and save it. The procedure for is then as follows:

1. Enable the change of the travel limits by pressing the two keys   at the same time. The LED above the  key will light.
2. Travel with the actuator to the desired position with the keys  .
3. Press the  key. The LED above the key starts to flash and expects the definition of the setting.
4. The definition is done with  for the Home Position,  for the Maximal Position and  for the Middle Position
5. On the displayed following comments will report completion.  
 Display first line:        [Save Pos]  
 Display second line:     [Done] or [Invalid]  
 In the case of [Invalid] the display flashes. The position couldn't be found e.g. because the “home” or “maximum” position was set over the middle position.



# 10 Parameter Setting over the Front Panel

## 10.1 Basic Instructions for Parameter Setting

The web guide controller has three operator modes:

- Operation mode
- Parameter Setting mode (parameter selection)
- Change mode (set or change chosen parameters)

The parameter setting can be performed via the keys on the front panel or via a web browser. When using the front panel, the user can toggle between these modes by pressing a key or a combination of keys. The keys have the following functions:

Key	Key function during parameter setting
	Enter
	Change the selections or increase / decrease the values

## 10.2 Setting of Operation Parameters

To enter the Parameter Setting Mode the web guide controller must be in the Manual Mode. In the Automatic Mode only the reference value can be changed.



Press the  key for longer than 3 sec. The LED will light and the first parameter

will appear on the LCD display. With the  keys the parameter list can be

scrolled up and down. By pressing the  key again you will enter the parameter setting mode. The select parameter on the display flashes indicating that it can be changed.

## 10.3 Setting of System Parameters



To enter the Parameter Setting Mode the web guide controller must be in the Manual

Mode. Press the  and  key together for longer than 3 sec to enter the System Parameter List. The LED will light and the first parameter will appear on the LCD display.

## 10.4 List of Operation Parameters

Parameter	LCD	Unit	Min	Max	Selection	Default
Adjust Reference Position	Ref Pos	mm	-5.00	+5.00	-	0.00
Set Reference Mode	Ref Mode	-	-	-	Manual Auto	Manual
Save the Reference Position	SaveRef	-	-	-	No Yes	No
Dead band	DeadBand	mm	0.0	2.0	-	0.1
Relay 1 or Relay 2 setting	Relay 1 Relay 2	-	-	-	MidSenso MatFound Auto&Mat Aut&Miss Auto Centre Disabled	R1= MidSenso  R2= MatFound
Digital Input 1, 2, 3 or 4 Modes	Input 1 Input 2 Input 3 Input 4	-	-	-	Edge→Aut Lv→Auto Centre - Ref/← +Ref/→ Lock ResetRef Disabled	I1= Edge→Aut I2=Center I3= -Ref/← I4= +Ref/→
DLS Sensor	DLS	-	-	-	none left right	none
Password	Password	-	-	-	No Yes	No
Language	Language	-	-	-	English German	English
LCD-Contrast	Contrast	%	1	100	-	65
Unit System	Unit Sys	-	-	-	Metric Imperial	Metric
Gain Setting	Gain	-	0.02	2.00	-	0.2
Adjust Correction Speed	AdjSpeed	%	1	100	-	100
Power Modes	Power ON	-	-	-	Manual Auto Last Set	Manual
Behaviour when leaving Automatic Mode	Auto→Man	-	-	-	Manual Centre	Manual

Parameter	LCD	Unit	Min	Max	Selection	Default
Home Position <sup>3)</sup>	Home Pos	mm	0.0	300.0	-	0.0
Middle Position <sup>3)</sup>	Mid Pos	mm	0.0	300.0	-	62.5 <sup>4)</sup>
Maximal Position <sup>3)</sup>	Max Pos	mm	0.0	300.0	-	125.0 <sup>4)</sup>
Actuator	Actuator	-	-	-	Left Right	Left
IP Address	IP Addr	-	0	125	-	192.168.0 .090
Subnet	Subnet	-	0	255	-	255.255.2 55.0
LAN Speed	LANSpeed	MBPS	-	-	10 100	
Factory Settings <sup>5)</sup>	Default	-	-	-	Not set Yes	Not Set

- 1) Permanent pressing of the   keys expedites the changing speed.
- 2) The display shows the unit of measure that was previously selected.
- 3) Parameter only used in winderGLIDE (actuator) applications
- 4) The default value is dependent on the actuator used. If you are using an actuator FMS winderGLIDE BKS.D.4 you have to use the system parameters similar to the BKS.D.3
- 5) System parameters are not reset, if the default function is used

## 10.5 Description of Operation Parameter

### Adjust Reference Position [Ref Pos]

**Purpose:** The reference position can be adjusted using this parameter.

**Range:** -5.00 to +5.00      **Default:** 0.00

**Increment:** 0.01      **Unit:** [mm]

### Set Reference Mode [Ref Mode]

**Purpose:** This parameter determinates how the reference position is defined. This can either be the position that is defined with parameter **[Ref Pos]** or the actual material position within the sensor when the controller is switched to automatic operation.

**Setting:** **[Manual]**

**Purpose:** If **[Manual]** is chosen, the Reference Position is taken from the parameter **[RefPos]**.

**Setting:** **Automatic [Auto]**

**Purpose:** If **[Auto]** behaviour is chosen, the Reference Position is determinate by taking the actual material position within the sensor when the controller is switched to automatic operation.

**Note:** The two parameters [RefMode] and [SafeRef] are conditionally dependent on each other. If you require one of both functions, either set [RefMode] to [Auto] or [SafeRef] to [Yes] .  
**Do not activate both functions simultaneously!**

**Save the Reference Position [SaveRef]**

**Purpose:** The parameter saves the last Reference Position change. It sets after re-booting the Reference Position to the last used value or to 0 (zero).

Two settings are possible:

**Setting:** [No]

**Purpose:** If [No] behaviour is chosen, the Reference Position is set to 0 after rebooting (default setting).

**Setting:** [Yes]

**Purpose:** If [Yes] behaviour is chosen, after rebooting the Reference Position is set to the last used value.

**Note:** The two parameters [RefMode] and [SafeRef] are conditionally dependent on each other. If you require one of both functions, either set [RefMode] to [Auto] or [SafeRef] to [Yes] .  
**Do not activate both functions simultaneously!**

**Dead band [DeadBand]**

**Purpose:** This parameter defines the dead band tolerance. Dead band is a free programmable range, in which the web may move freely without the steering readjusting the frame. Keep in mind that: A [DeadBand] of e.g. 0.3mm“ results in a tolerance band of  $\pm 0.3\text{mm}$ .  
If the deviation is higher than the tolerance, the web will be readjusted into the range of the dead band.

**Range:** 0.0 to 2.0 **Default:** 0.1  
**Increment:** 0.1 **Unit:** [mm]

**Relay 1 or Relay 2 setting [Relay 1 or 2] (two Parameters one for each relay)**

**Purpose:** This parameter determines the relay behaviour.  
The user can choose between seven settings.

**Setting:** **Middle Position [MidSenso]**

**Purpose:** If [MidSenso] is chosen then the relay goes on when the material edge is at the sensor’s middle position.  
(Default setting for Relay 1)

**Setting:** **Material Found [MatFound]**

**Purpose:** If [MatFound] is chosen then the relay goes on when material edge is detected. (Default setting for Relay 2)

**Setting:** **Automatic Mode and Material Found [Auto&Mat]**

**Purpose:** If [Auto&Mat] is chosen then the relay goes on when material edge is detected and the controller is in Automatic Operation.

**Setting:** **Automatic Mode and Material Missing [Aut&Miss]**

**Purpose:** If [Aut&Miss] is chosen then the relay goes on when no material edge is detected and the controller is in Automatic Operation.

**Setting:** **Automatic Operation [Auto]**

**Purpose:** If [Auto] is chosen then the relay goes on when the controller is in Automatic Operation.

**Setting:** **[Centre]**

**Purpose:** If [Centre] is chosen then the relay goes on as soon as the motor drive stands still after a centre run.

**Setting:** **[Disabled]**

**Purpose:** If [Disabled] is chosen then the relay function is disabled. The relay will never go on.

**Digital Input 1, 2, 3 or 4 Modes [Input 1...4]**

These are actually four parameters one for each digital input

**Purpose:** This parameter determines the functions of the digital inputs.  
**If edge (impulse) triggered: Length of impulse**  
 $L_{imp}: 100 \text{ ms} < L_{imp} < 500 \text{ ms}$   
 The user can choose between seven settings.

**Setting:** **Edge Triggered Automatic Mode [Edge→Aut]**

**Purpose:** The controller switches either to automatic or manual operation depending in which mode the controller currently is. The switching is taking place when a **rising edge** is detected on the digital input. (Default setting for dig. input 1)

**Setting:** **Level Controlled Automatic Mode [Lv→Auto]**

**Purpose:** The controller switches either to automatic or manual operation depending on the voltage level at the digital input. If the voltage is high then the controller switches to Automatic otherwise to Manual Operation.

**Setting:** **Drive to Center Position [Centre]**

**Purpose:** If [Centre] is chosen then the motor drive moves to the centre position. The event is edge triggered. (Default setting for dig. input 2)

**Setting:** **Decrease Reference Value or Move to the Left [-Ref/←]**

**Purpose:** The controller behaves in two different ways depending on the current operation mode. If the controller is in manual operation then the motor drive moves to the left respectively to the retracted position. If it is in automatic mode then the reference value is decreased. Default setting for dig. input 3)

**Setting:** **Increase Reference Value or Move to the Right [+Ref/→]**

**Purpose:** The controller behaves in two different ways depending on the current operation mode. If the controller is in manual operation then the motor drive moves to the right respectively to the extended position. If it is in automatic operation then the reference value is increased. (Default setting for dig. input 4)

**Setting:** **Lock Guide [Lock]**

**Purpose:** The motor drive is immediately locked when this parameter is chosen and the digital input voltage is high.  
 Dig. Input *Lock*, Operation State *Automatic* and Parameter *Auto→Man* work in a combinative manner. Their interdependency is described in the following table:

Dig. In. Lock	Op. State Automatic	Parameter Auto→Man	Function
0	inactive	Centre	Move to middle position
0	active	irrelevant	Automatic operation
1	inactive	Manual	Stop at actual position
1	inactive	Centre	Move to middle position
1	active	irrelevant	Stop at actual position

**Setting:** **Reset of Reference Value [ResetRef]**

**Purpose:** This function resets the reference value to 0, if a positive signal edge is applied to the digital input.

**Setting:** **Disabled**

**Purpose:** With [Disabled] parameter the digital input is disabled.

## DLS

**Purpose:** If you use a DLS2 sensor, you have to set the correct installation direction. You can only connect one DLS2 sensor.

**The user can choose between three settings.**

**Setting:** **[none]**

**Purpose:** There is no DLS2 sensor connected

**Setting:** **[left]**

**Purpose:** The DLS2 sensor is installed on the left-hand side (in direction of the moving web)

**Setting:** **[right]**

**Purpose:** The DLS2 sensor is installed on the right-hand side (in direction of the moving web)



**Password**

**Purpose:** The web guide controller can be protected from unauthorised access by means of password. If *Password Yes* is chosen, the system will request the password to change parameters and other setting. The password itself can't be changed. It is always **3231**  
**The user can choose between two settings.**

**Language:** **[No]**

**Purpose:** The Password protection is deactivated (default setting)

**Language:** **[Yes]**

**Purpose:** The Password protection is activated

### Language

**Purpose:** This parameter determines the displayed language.  
**The user can choose between two languages.**

**Language:**

**Purpose:** If **[English]** is chosen, the display shows all texts in English. The web browser is always in English.

**Language:**

**Purpose:** If **[German]** is chosen, the display shows all texts in German.

### LCD-Contrast [Contrast]

**Purpose:** The parameter **[Contrast]** changes the contrast of the LCD to achieve optimal readability.

<b>Range:</b>	1 to 100	<b>Default:</b>	65
<b>Increment:</b>	1	<b>Unit:</b>	[%]

### Unit System [Unit Sys]

**Purpose:** This parameter determines the unit system used.  
**The user can choose between two settings.**

**Setting:**

**Purpose:** If **[Metric]** is chosen, the controller displays all data in metric units.

**Setting:**

**Purpose:** If **[Imperial]** is chosen, the controller shows all data in imperial units.

### Gain Setting [Gain]

**Purpose:** This parameter defines the gain of the feed back value.

<b>Range:</b>	0.02 to 2.00	<b>Default:</b>	0.20
<b>Increment:</b>	0.01	<b>Unit:</b>	[-]

**Adjusting Correction Speed [AdjSpeed]**

**Purpose:** This parameter determines the maximum used speed.

<b>Range:</b>	1	to	100	<b>Default:</b>	100
<b>Increment:</b>	1			<b>Unit:</b>	[%]

**Power Modes [Power ON]**

**Purpose:** This parameter determines the operation mode after power on.  
**The user can choose between three behaviours.**

**Setting:** **[Manual]**

**Purpose:** The controller goes to Manual Operation Mode after power on.

**Setting:** **Automatic [Auto]**

**Purpose:** The controller goes to Automatic Operation Mode after power on.

**Setting:** **Last Setting Used [Last Set]**

**Purpose:** The controller restores the operation mode that was previously chosen before power off.

**Behaviour when leaving Automatic Mode [Auto→Man]**

**Purpose:** This parameter determines the behaviour of the controller leaving the automatic mode.

**The user can choose between two behaviours.**

**Setting:** **[Manual]**

**Purpose:** The controller stops guiding. The motor drive is locked at the current position (Manual Mode).

**Setting:** **[Centre]**

**Purpose:** The controller stops guiding. Afterwards the motor drive moves to the centre.

### Home Position [Home Pos]

<b>Purpose:</b>	This parameter determines the position of the actuator spindle in its retracted position. An actuator stops at this position and moves no further backwards (ref. also to chapter 9.5 “ Saving the Travel Limits”).		
<b>Range:</b>	0.0 to 300.0	<b>Default:</b>	0.0
<b>Increment:</b>	0.1	<b>Unit:</b>	[mm]
<b>Condition:</b>	This parameter appears on the display only if an actuator / winderGLIDE is connected to the controller.		

### Middle Position [Mid Pos]

<b>Purpose:</b>	The [Mid Pos] parameter determines the centre position of the actuator spindle. An actuator stops at this position, if you press the centre key  . In Automatic Operation this parameter has no meaning.		
<b>Range:</b>	0.0 to 300.0	<b>Default:</b>	62.5 <sup>4)</sup>
<b>Increment:</b>	0.1	<b>Unit:</b>	[mm]
	4) The default value is dependent on the used actuator		
<b>Condition:</b>	This parameter appears on the display only if an actuator / winderGLIDE is connected to the controller.		

### Maximal Position [Max Pos]

<b>Purpose:</b>	This parameter determines the limit for the extended position. An actuator stops at this position and moves no further forward. (ref. also to chapter 9.5 “ Saving the Travel Limits”).		
<b>Range:</b>	0.0 to 300.0	<b>Default:</b>	125.0 <sup>4)</sup>
<b>Increment:</b>	0.1	<b>Unit:</b>	[mm]
	4) The default value is dependent on the used actuator		
<b>Condition:</b>	This parameter appears on the display only, if an actuator / winderGLIDE is connected to the controller.		

**Actuator [Actuator]**

**Purpose:** The parameter [Actuator] determines the control logic of the web guide controller BKS309.EIP.

**Condition:** This parameter appears on the display only if an actuator / winderGLIDE is connected to the controller.

The user can choose between two control directions.

**Action:** **[Left]**

**Purpose:** [Left] is the control direction when the actuator is mounted on the left side of the unwind/rewind station seen in direction of the running web (see Fig. 3)

**Action:** **[Right]**

**Purpose:** [Right] is the control direction when the actuator is mounted on the right side of the unwind/rewind station seen in direction of the running web (see Fig. 3)

**[IP Addr]**

**Purpose:** The parameter assigns an IP address to the controller. This enables the user to communicate via a web browser with the controller that is imbedded in a network. The IP address must be entered in 4 separate blocks (IP Bl. 1; IP Bl. 2; IP Bl. 3; and IP Bl. 4)

**Range:** 0 to 255 **Default:** 192.168.0.091

**Increment:** 1 **Unit:** [-]

**[Subnet]**

**Purpose:** The parameter assigns the Subnet Mask of the controller in the Ethernet network. This enables the user to communicate via a web browser with the controller. The Subnet Mask must be entered in 4 separate blocks (Sub. Bl 1; Sub. Bl 2; Sub. Bl 3; and Sub. Bl 4).

**Range:** 0 to 255 **Default:** 255.255.255.0  
**Increment:** 1 **Unit:** [-]

**[LANSpeed]**

**Purpose:** [LANSpeed] determines the data speed of the web guide controller to communicate the receiver (Switch, Hub or PC).

**Selection:** 10 or 100 **Default:** 100  
**Unit:** [MBPS]

**Factory Settings [Default]**

**Purpose:** This menu point is a command. It resets the parameters to the factory settings.

The user can choose between two actions.

**Action:** [Not Set]

**Purpose:** If [Not Set] is chosen, all parameters stay as set by the user.

**Action:** [Yes]

**Purpose:** If [Yes] is chosen, the default parameters are loaded.



**Note**



*The operation parameters [Home Pos], [Mid Pos], [Max Pos], [Teach-in] as well as all system parameters are not reset with the factory setting command [Default].*

## 10.6 Description of System Parameters



### **Caution**

*System parameters are factory settings and should not be changed without contacting the service department of FMS. An unauthorised change can cause malfunctions in the system or damage in the machine.*

To enter the System Parameter Setting Mode hold the two  +  keys for longer than 3 sec. The LED will light and the first parameter will appear on the LCD display

### Offset Centre [Offset><]

**Purpose:** This parameter adjusts the position of a steering frame exactly to the centre.

### Position Detection [PosDetec]

**Purpose:** This parameter determines what devices that are used to detect the limit positions.

**The user can choose between three types.**

**Type:** [Potentio]

**Purpose:** A potentiometer is used to detect the Home position, Middle Position and Maximum Position. It is automatically set, if an actuator / winderGLIDE of the type BKS.D.3 or BKS.D.4 is used.

**Type:** [One Hall]

**Purpose:** One hall sensor is used to detect the Home position, Middle Position and Maximum Position.

**Type:** [Two Hall]

**Purpose:** Two hall sensors are used to detect the Home position, Middle Position and Maximum Position.

### Centre Position [CentrPos]

**Purpose:** The [CentrPos] parameter is only used with the position detection system based on hall sensors. For all other position detection system this parameter is not used and hence not displayed. The parameter determines the centre position of the actuator spindle in motor steps (measured from the left reference position). The actuator stops at this position, if you press the centre key . In Automatic Operation this parameter has no meaning.

### Right Limit [RightLim]

**Purpose:** The [RightLim] parameter is only used with the position detection system based on hall sensors. For all other position detection system this parameter is not used and hence not displayed. The parameter limits the maximum travel to the right side of the actuator spindle in motor steps (measured from the left reference position). In the operation or in manual mode this limit will never be exceeded

### Drive Direction [DriveDir]

**Purpose:** This parameter determines the guiding orientation of the controller. Usually turn stepper motors clockwise. This setting changes the turning direction of the motor. There are two other possibilities to change the guiding direction:

- a) Changing the electrical polarisation of the stepper motor
- b) Mounting the actuator in the opposite direction

**The user can choose between two settings**

**Setting:** [Standard]

**Purpose:** [Standard] is chosen when standard motors and standard frames are used.

**Setting:** [Invers]

**Purpose:** [Invers] is chosen when motors are used that turn anticlockwise. If a FMS actuator of the type winderGLIDE is used, the controller sets the drive direction automatically.



## Actuator Type [winderGL]

**Purpose:** This parameter determines the used actuator type. The product name of FMS actuators is winderGLIDE.

**The user can choose between three types.**

**Type:** [D.3.125] or [D.6.125]

**Purpose:** If type [D.3.125] or [D.6.125] is chosen, the maximum travel of the spindle will be 125mm (4.92in). It is the maximum travel position.

**Type:** [D.3.200] or [D.6.200]

**Purpose:** If type [D.3.200] or [D.6.200] is chosen, the maximum travel of the spindle will be 200mm (7.87in). It is the maximum travel position.

**Type:** [D.3.300] or [D.6.300]

**Purpose:** If type [D.3.300] or [D.6.300] is chosen, the maximum travel of the spindle will be 300mm (11.81in). It is the maximum travel position.



### **Warning for BKS.D.4**

***If you are using an FMS winderGLIDE BKS.D.4 you have to select the parameter for the BKS.D.3 with the corresponding stroke of 125 or 200mm.***

## 10.7 Reset to Default Parameter Set

Factory settings of your BKS309.EIP web guide controller can be re-established either over the parameter setting menu (see chapter 8.2 “Setting of Operation Parameters”, parameter [Default]) or by:

Holding the two keys  +  while powering -up the controller.

# 11 Parameter Setting via a PC

The BKSZ309 web guide controller can be embedded in an Ethernet network and the parameter setting can be done over this network by means of a web browser (Internet Explorer 7). The devices have a static IP-address that can be set over the user interface. The IP-address is not automatically received over DHCP. The parameter setting can also be carried out with a desktop- or laptop computer via a peer-to-peer connection (see **chapter 11.2**)

BKS309.EIP configuration in a LAN (Local Area Network):

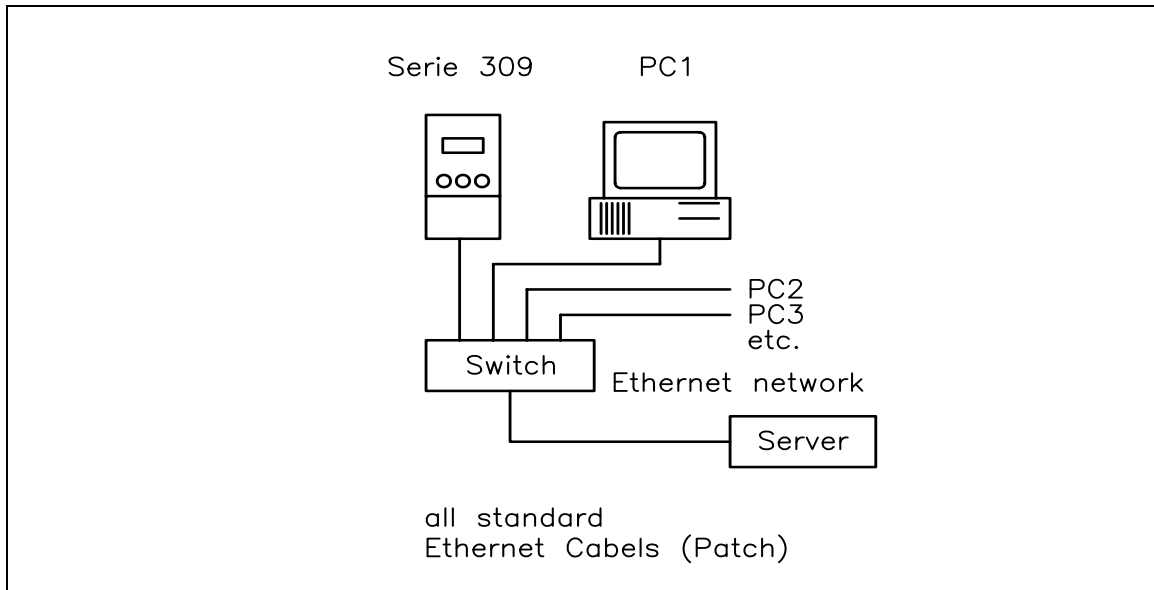



Fig. 24: BKS309.EIP embedded in a LAN

EMGZ309001e

 **Note**  
*Fig. 25 and 26 show the peer-to-peer connection between PC und BKS309.EIP. Please be aware that for this configuration a cross-over-cable needs to be used.*

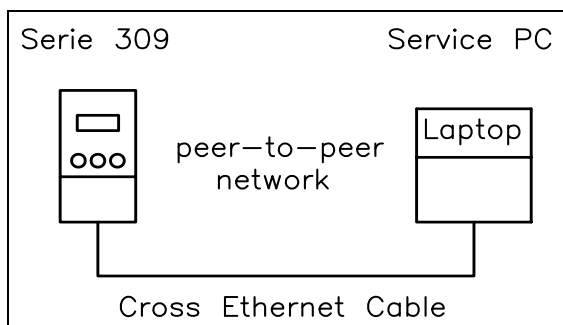

Fig. 25: Correct connection with cross-over-cable. E309002e

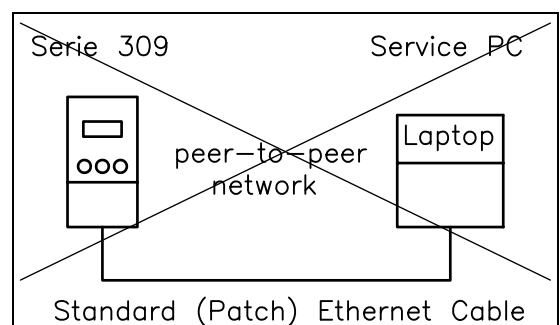

Fig 26: Connection with wrong cable E309003e

## 11.1 Parameterization in a Network via Web Browser

Before the parameterization of the BKS309.EIP it must be certain that the BKS309.EIP uses an IP address in a static block. For the integration of a BKS309.EIP web guide controller in your Ethernet network please contact your IT system administrator.

Once the BKS309.EIP was integrated in the network you can address the device e.g. with <http://192.168.000.090> . After establishing the link, the screen Fig. 27 will open up.

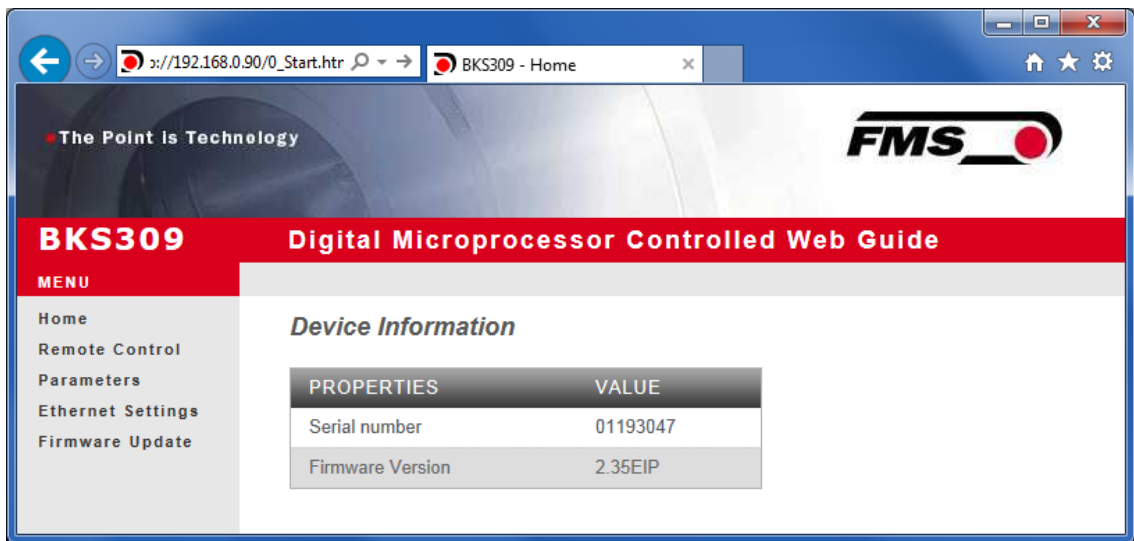
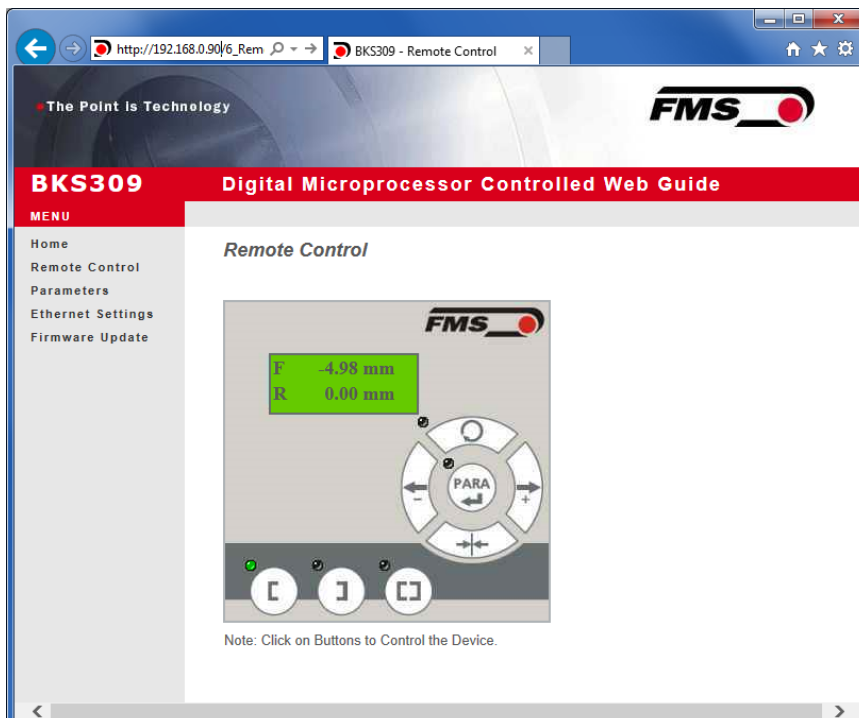

Fig. 27: Serial number and device information

Home.jpg

With the menu on the left side of the screen you can navigate through the web page.



**Fig. 28:** Parameter setting and Remote Control

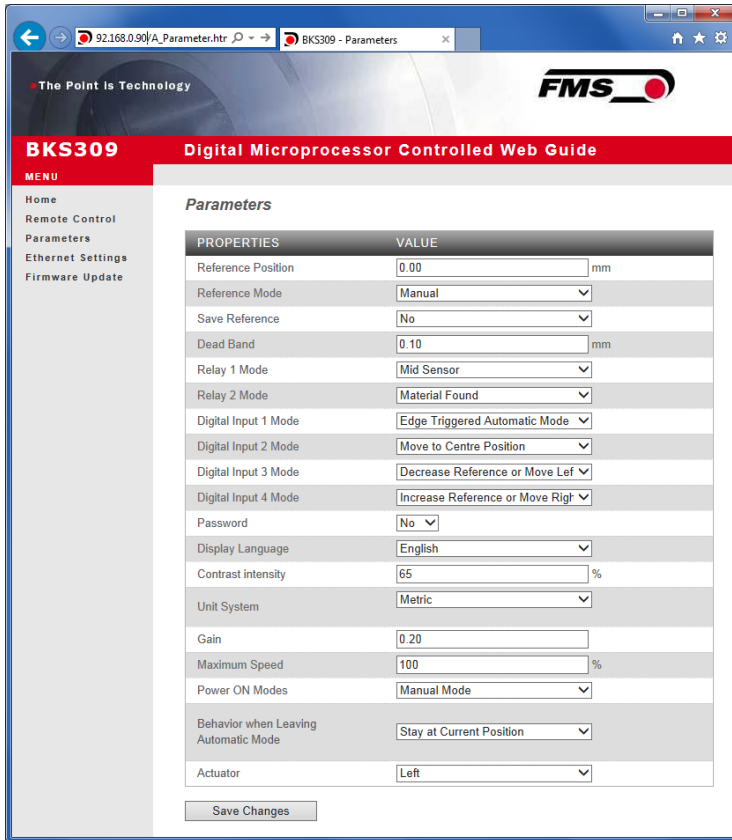

Fig. 29: Parameter list for Steering Frames webMASTER

Parameters w/o winderGLIDE

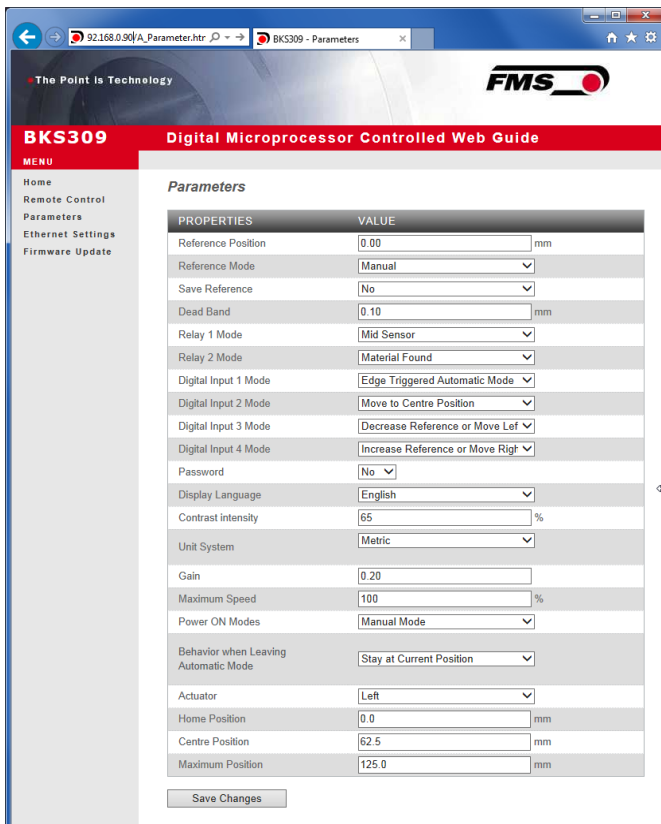

Fig. 30: Parameter list for Actuators winderGLIDE

Parameters w winderGLIDE

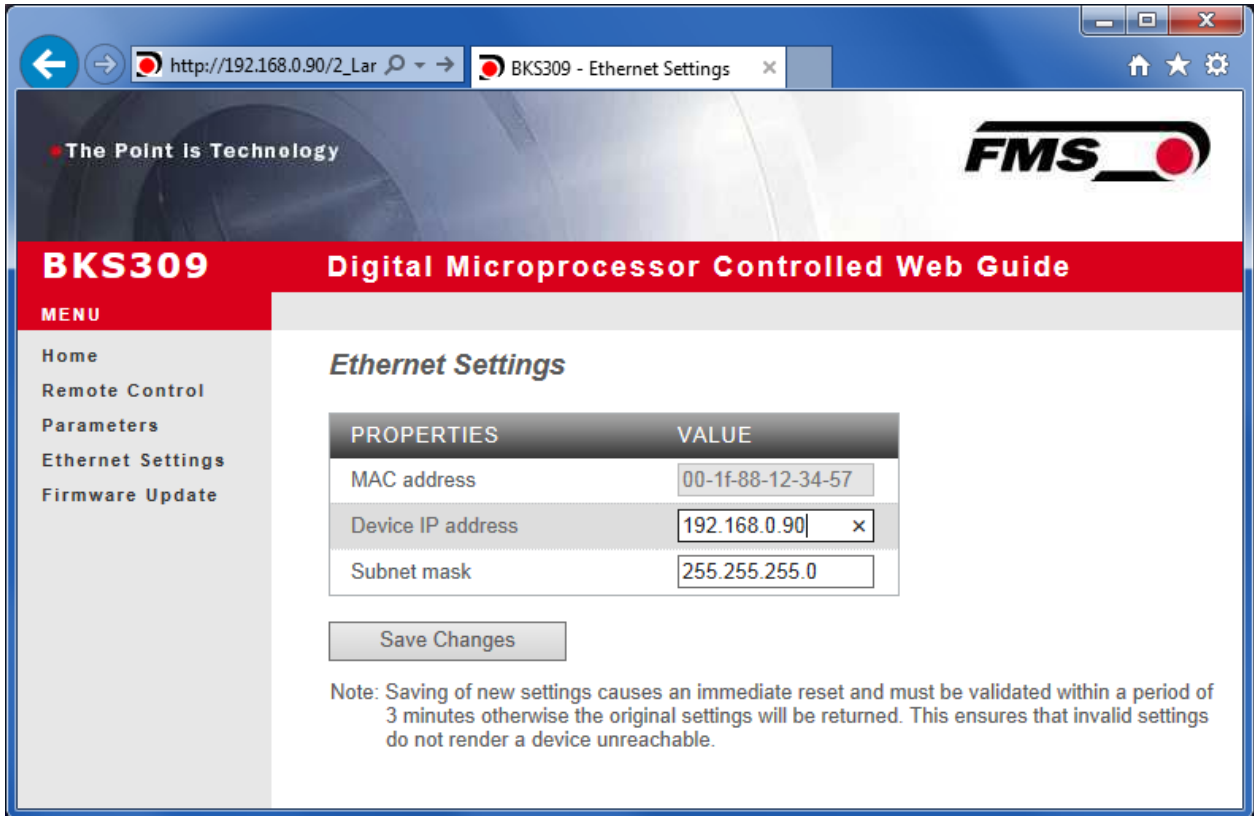

Fig. 31 Ethernet settings and device addresses

Ethernet Settings

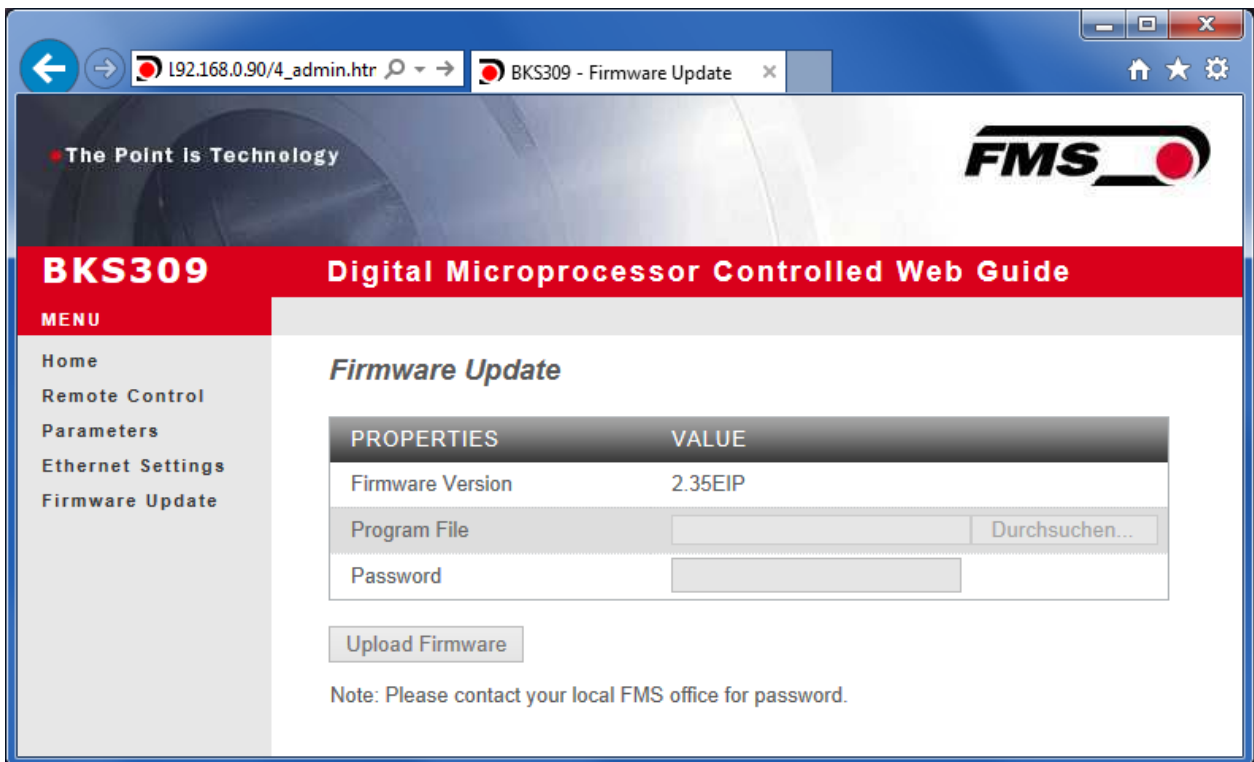

Fig. 32: Firmware update

Firmware Updates

## 11.2 Parameterization via a PC (peer-to-peer connection)

This chapter describes the procedure for setting up a desktop or laptop computer to communicate with FMS BKS309.EIP web guide controller.

Before connecting the FMS BKS309.EIP controller with a “cross-over-cable” directly to a PC, the computer must be configured with a “static” IP address. If the BKS309.EIP controller is connected to a network by using e.g. a switch, the following procedure is not necessary. To establish the connection between your PC and the BKS309.EIP follow the steps below.

Setup in Microsoft Windows XP:

1. Click on the Start button (lower left-hand corner of the screen)
2. Click on Control Panel
3. Double click on Local Area Network
4. Right click on the network adapter that is used for the connection.
5. Click on Properties on the pop up menu, the following dialog box “Local Area Connection Properties” will appear.

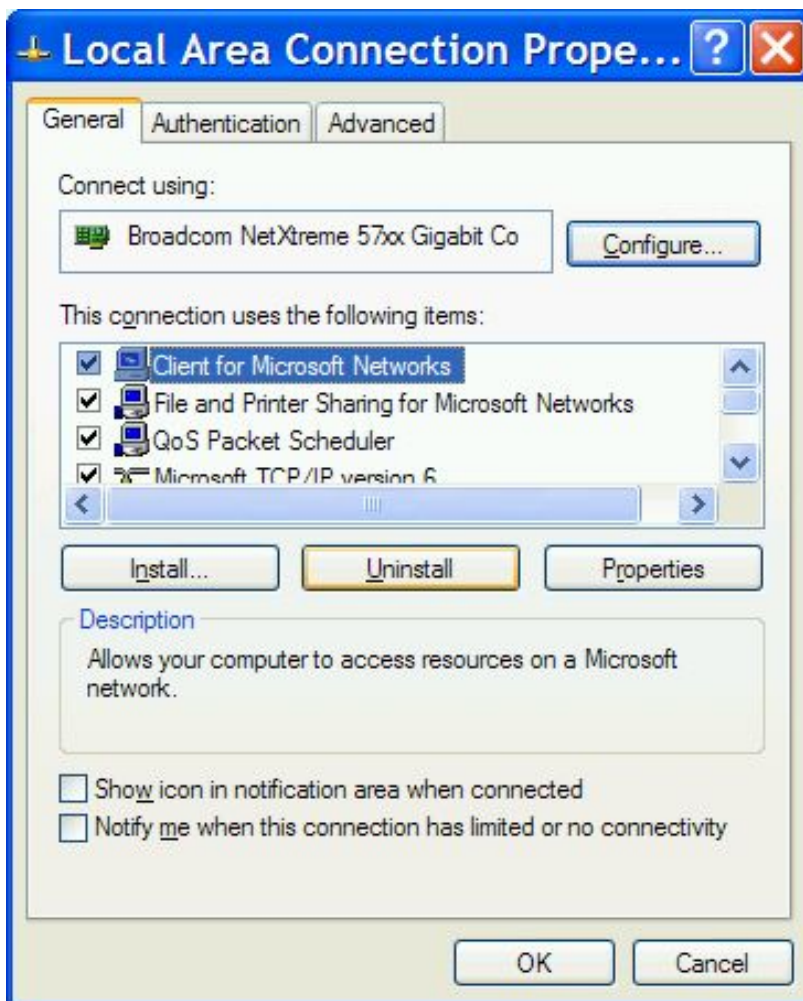

In the list box “This connection uses the following items:”, scroll down to “Internet Protocol (TCP/IP)”. Select the “Internet Protocol (TCP/IP)” and click “Properties” button.

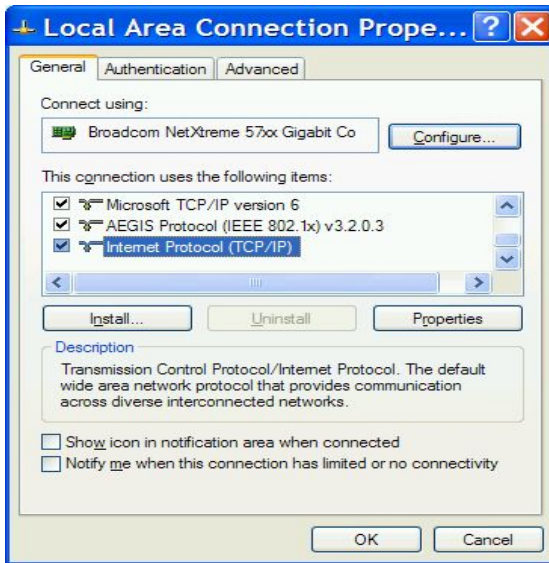

The following dialog box will appear. Make sure the “General” tab is selected.

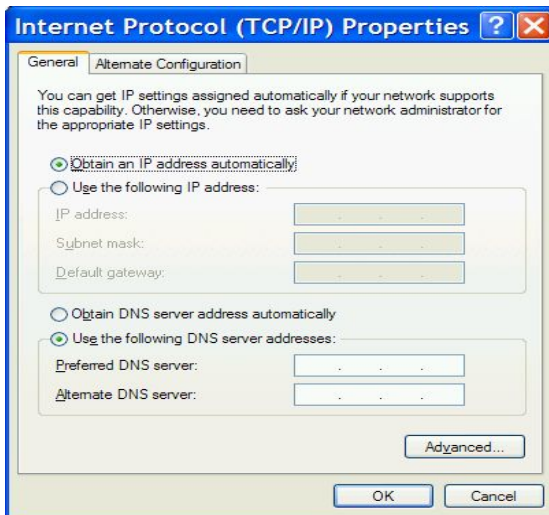

Select the radio button “Use the following IP address:”

In the IP address box enter the IP address for the computer that could be 192.168.0.1.

In the Subnet mask, enter 255 255 255 000, as shown below.

Notice that the “000” in both boxes will change automatically to “0”.

The dialog box will change to look like the following:



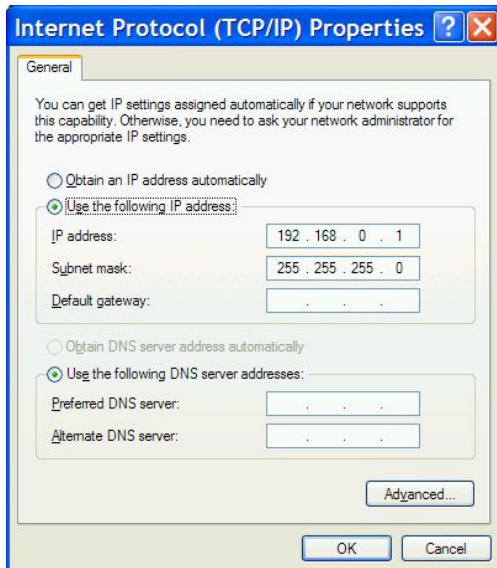

Click the “OK” button. The following dialog box will appear again:

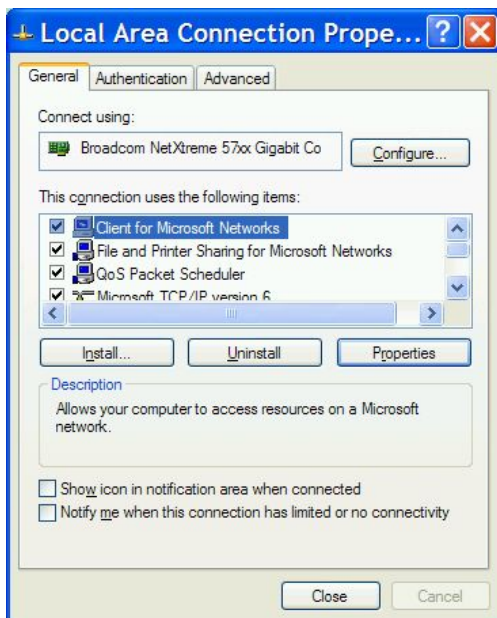

Click on the “Close” button.

Close the “Network Connection” window

Close “Control Panel”

The computer is now ready to communicate with the BKS309.EIP controller:

1. Connect the “cross over cable” to both the BKS309.EIP and to the appropriate port on the desktop or laptop computer.
2. Open web browser (Microsoft Internet Explorer, Mozilla Firefox or similar)
3. The default IP address for the BKS309.EIP is 192.168.000.091 as long as it was not changed over the operating period. Enter the IP address in the address bar and hit the Enter key. If a different IP address and subnet mask is configured at the BKS309.EIP make sure that the computer is setup appropriate.
4. The screen **Fig. 27** will open up. Continue then with the procedure described in **11.1** “Parametrization in a Network via a Web Browser”.

## 12 Mechanical Dimensions

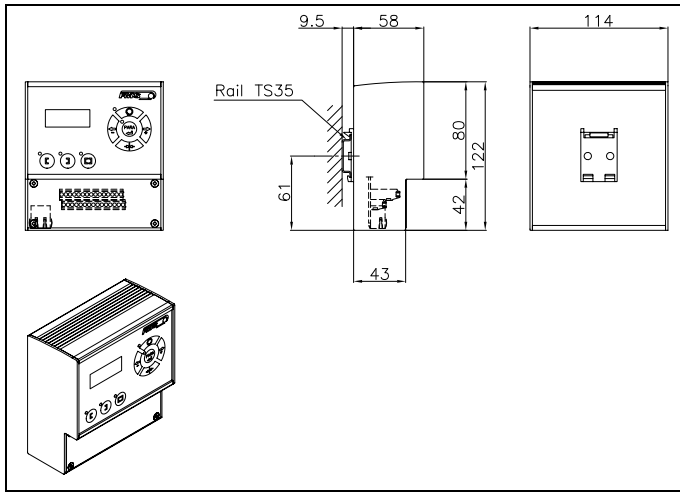

Fig. 33: Outline Drawing BKS309.R.EIP rail mount housing

K309006e

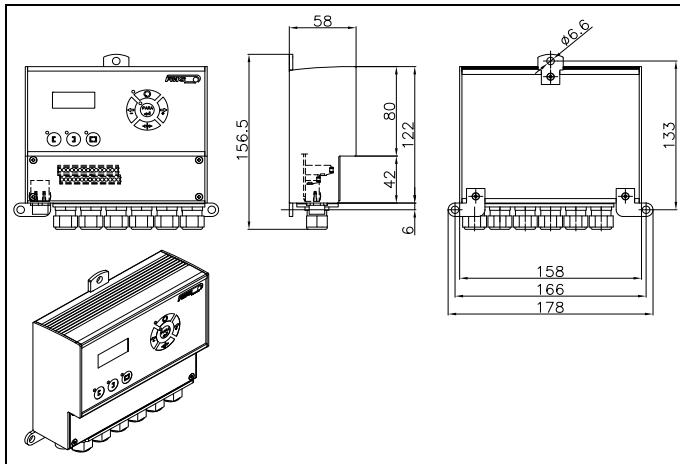

Fig. 34: Outline Drawing BKS309.W.EIP wall mount housing

K309008e

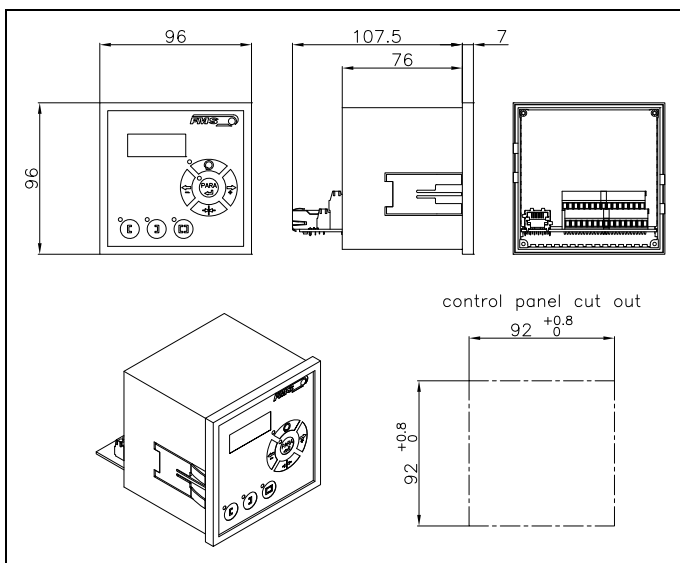

Fig. 35: Outline Drawing BKS309.S.EIP panel mount housing

K309007e

## 13 Trouble Shooting

Error	Cause	Corrective action
<b>Edge outside detection band</b>	Edge has moved outside the sensor detection band	Adjust sensor more accurately to the web edge; Adjust reference position less during automatic operation
<b>BKS guides web edge immediately out of the sensor</b>	Sensor is mounted on the wrong side	Mount sensor to the correct side (right sensor for „Edge right“, etc.)
	Sensor is connected to the wrong socket	Connect sensor plug to the correct socket (left plug to left socket, etc.)
<b>Steering frame does not move</b>	No signal; sensor not correctly connected	Connect sensor correctly according to screw terminal arrangement and installation guide
	No signal; cable interruption	Replace cable or send sensor to FMS
	No signal; sensor defect	Send sensor to FMS; use other sensor
<b>No response of the interface</b>	Wiring not correct	Check wiring
<b>Display shows nothing, frame doesn't react</b>	Power supply defect	Check or correct power supply installation
	Electronic control unit defect	Contact FMS customer service
<b>Frame moves abrupt to one of the end positions</b>	Stepper motor driver defective	Exchange actuator of the frame. Contact FMS service department for spare parts and installation guide.

## 14 Technical Specification

Processor cycle time	1ms
EtherNET/IP minimum cycle time	2 ms
Drive of steering frame	Stepper motor. Power amplifier 24V integrated in housing
Dead band	0 to 2mm, adjustable in 0.1mm steps
Position reference	±5mm, adjustable in 0.1mm steps
Control modes	edge left / edge right / center guiding / line guiding
Interface	Web browser Ethernet Explorer 7 or higher
Operation	3 keys and 5-key wind rose pad
Analogue inputs	2 inputs 0 to 10V (for sensors)
Digital inputs	4 dig. inputs 24VDC galvanic insulated
Relay outputs	2 relay outputs. DC: 220V/2A/60W; AC:250V/2/62.3VA
Supply voltage	18 to 30 VDC (Vnom.= 24 VDC)
Temperature range	-10 to 60 °C (14 to 140 °F)
Protection class	IP 30 (Standard) / IP65 (.W), IP00 (.S)



**FMS Force Measuring Systems AG**  
 Aspstrasse 6  
 8154 Oberglatt (Switzerland)  
 Tel. +41 44 852 80 80  
 Fax +41 44 850 60 06  
 info@fms-technology.com  
 www.fms-technology.com

**FMS USA, Inc.**  
 2155 Stonington Avenue Suite 119  
 Hoffman Estates., IL 60169 (USA)  
 Tel. +1 847 519 4400  
 Fax +1 847 519 4401  
 fmsusa@fms-technology.com

**FMS (UK)**  
 Aspstrasse 6  
 8154 Oberglatt (Switzerland)  
 Tel. +44 1767 221 303  
 fmsuk@fms-technology.com

**FMS (Italy)**  
 Aspstrasse 6  
 8154 Oberglatt (Switzerland)  
 Tel. +39 02 39487035  
 fmsit@fms-technology.com