



FMS-cradleGUARD™ Operating Manual and Installation Instructions

Wireless Signal Transmission from Cradle to Control Station

Document Version 2.92
Firmware Version 0.72
Published / Author 04/2024 / NS



**Diese Bedienungsanleitung ist auch in Deutsch erhältlich.
Bitte nehmen Sie mit der nächstgelegenen FMS Niederlassung Kontakt auf.**

1 Content

1	CONTENT	2
2	SAFETY INFORMATION	3
2.1	Presentation of Safety Information	3
2.1.1	Danger that Could Result in Minor or Moderate Injuries.....	3
2.1.2	Note Regarding Proper Function	3
2.2	General Safety Information	3
3	PRODUCT INFORMATION	5
3.1	Functional Description	5
3.2	System Requirements	5
3.3	Main Components	5
3.4	Scope of Supply	6
4	INSTALLATION	7
4.1	As-delivered Condition	7
4.2	Preparation	7
4.3	Installation of the FMS-cradleGUARD.T Transmission Module	8
4.4	Electrical connection of the FMS-cradleGUARD.T and FMS-cradleGUARD.T.24VDC transmission modules	9
4.4.1	Specifications for sensors and switches (not relevant for FMS-cradleGUARD.T.24VDC).....	11
4.5	Electrical Connection of the FMS-cradleGUARD.R Receiver Module	14
5	DISPLAY AND OPERATION	15
5.1	Configuration on the Device	16
5.2	Display	18
5.3	Configuration via Web Interface	19
6	TECHNICAL DATA	26
6.1	FMS-cradleGUARD.R Receiver Module	26
6.2	FMS-cradleGUARD.T Transmission Module	26
6.3	Certifications.....	27
7	DIMENSIONS	28
7.1	FMS-cradleGUARD.R Receiver Module	28
7.2	FMS-cradleGUARD.T Transmission Module	29
7.3	FMS-cradleGUARD.T.24VDC Transmission Module.....	30
8	TROUBLESHOOTING, FAQ	31

2 Safety Information

All safety information, operating and installation regulations listed here ensure proper function of the device. Safe operation of the systems requires compliance at all times. Noncompliance with the safety information or using the device outside of the specified performance data can endanger the safety and health of persons.

Work with respect to operation, maintenance, retrofit, repair, or setting of the device described here must only be performed by expert personnel.

2.1 Presentation of Safety Information

2.1.1 Danger that Could Result in Minor or Moderate Injuries

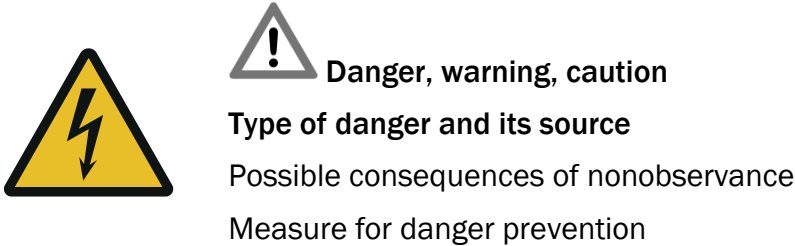

2.1.2 Note Regarding Proper Function

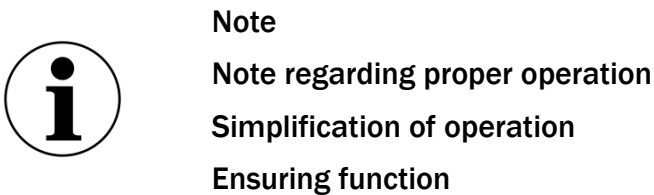

2.2 General Safety Information

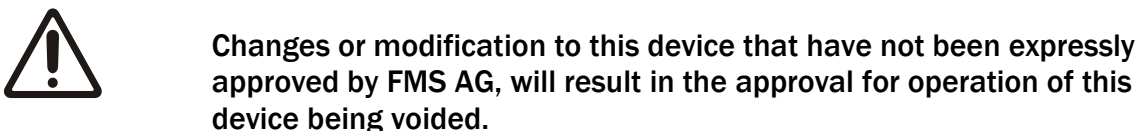
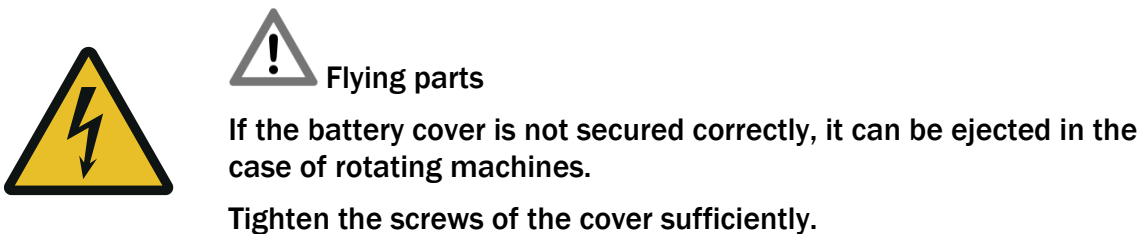



The function of this system is only ensured with the components in the specified layout to one another. Otherwise, severe malfunctions may occur. Thus, the installation information on the following pages must be followed.



The local installation regulations ensure the safety of electrical systems. They are not considered in these operating instructions. However, they must be met.



Electrical connections must be implemented by an expert.



All system components are sensitive components that can be damaged in the case of improper installation! Installation must be performed by trained service personnel!

3 Product Information

3.1 Functional Description

The FMS-cradleGUARD consists of two different system components. A transmission module (FMS-cradleGUARD.T) per cradle contains terminal blocks for up to 3 sensors and the radio module. The radio frequencies can be clearly separated and ensure operational safety. The receiver module (FMS-cradleGUARD.R) outside of the machine receives the signals of the individual transmission modules and indicates their status in plain text on the display. The integrated relay outputs can be connected directly to the PLC and a warning indicator. The system can be conveniently configured via the web interface using a browser.

3.2 System Requirements

The FMS-cradleGUARD is an independent system. Respective sensors must be present on the machine.

3.3 Main Components

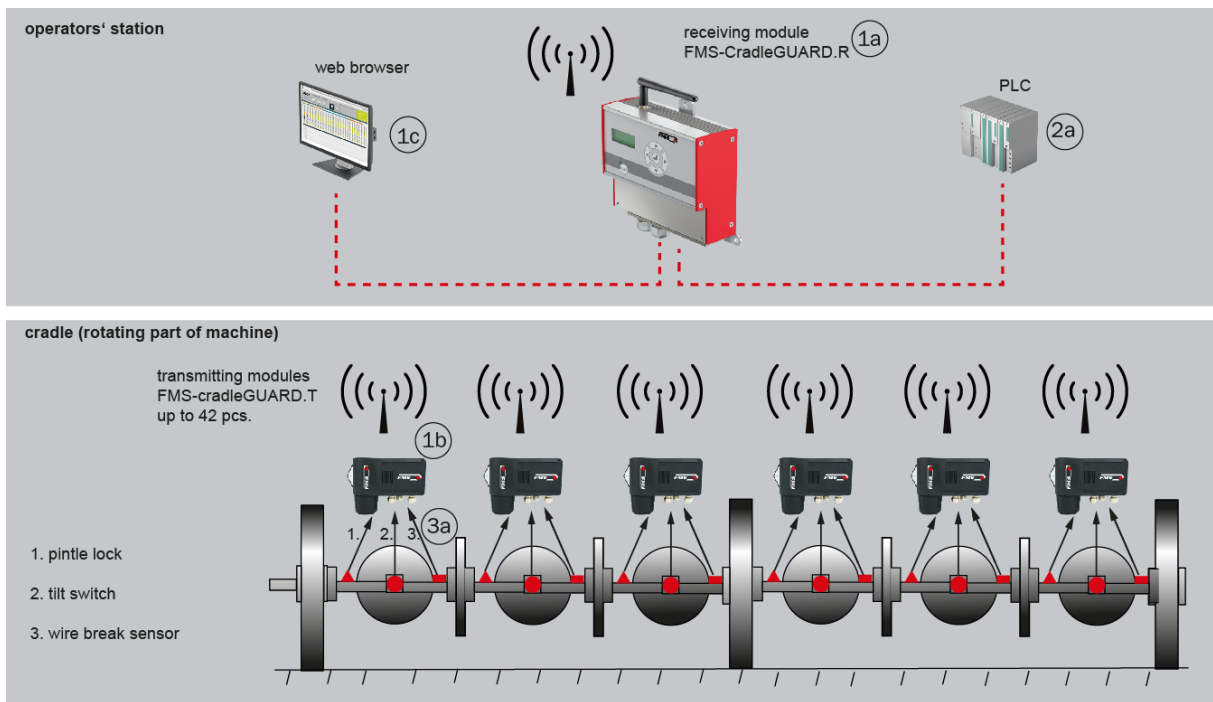

Figure 1: FMS-cradleGUARD Main Components

Main component designations	
Item	Description
Item 1	FMS-cradleGUARD system components
1a	Receiver module FMS-cradleGUARD.R, status display for up to 42 transmission modules
1b	Transmission module FMS-cradleGUARD.T with inputs for sensors, incl. rechargeable battery
1c	Alternative status indicator and configuration via web interface
Item 2	Connection to main control
2a	Connection to PLC, relay outputs
Item 3	Sensors on spool cradle
3a	Up to 3 per FMS-cradleGUARD.T transmission module or per cradle
not shown	24 VDC connection for FMS-cradleGUARD.R receiver module, Ethernet cable, etc.

Table 1: Main Components

3.4 Scope of Supply

Scope of supply:

Receiver module FMS-cradleGUARD.R, transmission module(s) FMS-cradleGUARD.T, rechargeable battery, charger

The following is not included in the scope of supply:

Sensors, switches (including cables), installation material; installation and start-up: our experts will assist you upon request

Accessories:

Spare batteries and chargers as required, 24 VDC power supply for FMS-cradleGUARD.R receiver module, patch cable for the connection of receiver module and (e.g.) laptop for configuration via web interface.

Option:

FMS-cradleGUARD.T.24VDC version, for connection to existing 24 VDC power supply (required on all cradles). No batteries, no chargers required

4 Installation

4.1 As-delivered Condition

FMS-cradleGUARD.R Receiver Module

- IP address 192.168.000.090
- Radio channel preset

FMS-cradleGUARD.T Transmission Module(s)

- Radio channel preset
- To keep them apart, the individual transmission modules are labeled with individual ID. The ID can be found on a label on the housing.
- The batteries are enclosed and must be inserted.

4.2 Preparation

When installing the system components, the following conditions must be met to ensure proper function.



The components may not be subjected to loads outside of the specified values during installation and operation later.



The fastening points for supporting the components must be designed correctly. Pay attention to proper installation of the FMS-cradleGUARD.T transmission modules on the machine.



The sensors must be connected electrically correctly.

4.3 Installation of the FMS-cradleGUARD.T Transmission Module

The receiver modules must be installed on the cradle on a flat surface. The contact surfaces must be as even as possible.

Use the enclosed fastening brackets for installation.

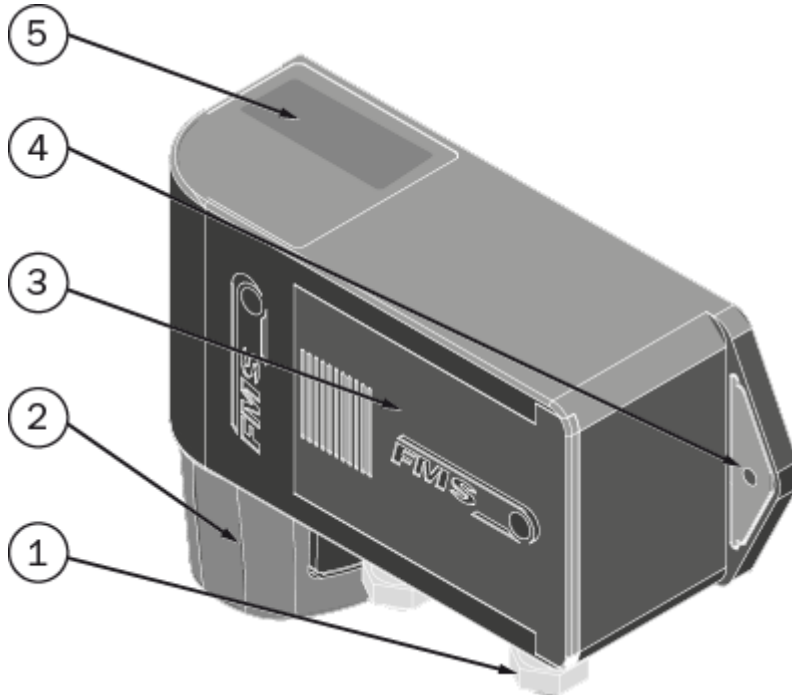

Figure 2: FMS-cradleGUARD.T

FMS-cradleGUARD.R	
Item	Description
1	Pg-glands for cable connections
2	Rechargeable battery with quick connector
3	Sliding door
4	Fastening lug
5	Type label

Table 2: FMS-cradleGUARD.R



Battery access

Ensure easy access to the battery when selecting the installation location.



Installation direction

During alignment of the housing, make sure that the side with the electrical connections and the battery points downwards if possible.



In the case of small machines and light-weight cradles, make sure that the additional weight of the transmission module may have to be compensated to avoid any imbalance.

We recommend a centered installation of the receiver modules on the cradle to avoid this effect.

4.4 Electrical connection of the FMS-cradleGUARD.T and FMS-cradleGUARD.T.24VDC transmission modules

We recommend a cable with 3 x 0.5 mm² for the sensor connection. The cables must be routed separately from power cables.

If you choose to use the 24 VDC power supply, please make sure to use a cable 3 x 0.5 mm².

First, remove the cover on the connection side. Next, the board with the terminal blocks can be pulled as far as it goes.

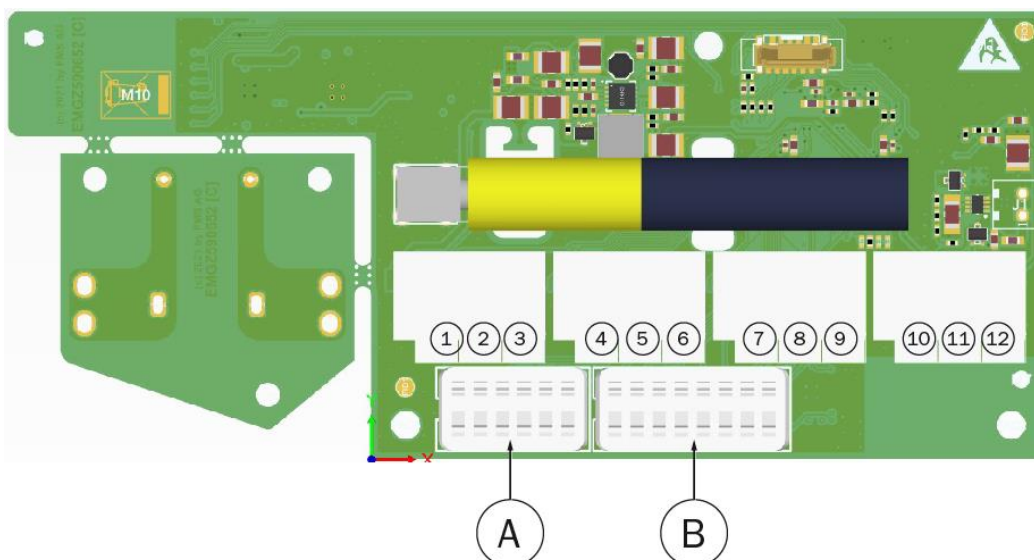

Figure 3: FMS-cradleGUARD.T Terminal Designation and Connection



Designation of sensors

You can modify the below stated names (Pintle,...) of the sensors via the web browser.

FMS-cradleGUARD.R	
Item	Description
1 to 3	<p>Sensor 1 – PINTLE LEFT (pintle lock left)</p> <p>Terminal 1: +12 VDC power supply (can be measured using an oscilloscope only)</p> <p>Terminal 2: Signal / switch</p> <p>Terminal 3: GND / reference</p>
4 to 6	<p>Sensor 2 – PINTLE RIGHT (pintle lock right)</p> <p>Terminal 4: +12 VDC power supply (can be measured using an oscilloscope only)</p> <p>Terminal 5: Signal / switch</p> <p>Terminal 6: GND / reference</p>
7 to 9	<p>Sensor 3 – WIRE BREAK</p> <p>Terminal 7: +12 VDC power supply (can be measured using an oscilloscope only)</p> <p>Terminal 8: Signal / switch</p> <p>Terminal 9: GND / reference</p>
10 to 12	<p>Optional 24 VDC (18 to 36 VDC) power supply, substitutes batteries</p> <p>Terminal 10: +12 VDC</p> <p>Terminal 11: GND</p> <p>Terminal 12: PE</p>
not shown	Battery compartment
A	Dip switch for channel assignment (do not change!)
B	Dip switch for setting the ID (do not change!)

Table 3: Terminal Block for FMS-cradleGUARD.T Sensors



Power supply to sensors is 12 VDC

The FMS-cradleGUARD.T(.24VDC) supplies 12 VDC to the sensors.



Do not manipulate the Dip switches!

Changing the Dip switches will result in the loss of the radio connection.

4.4.1 Specifications for sensors and switches (not relevant for FMS-cradleGUARD.T.24VDC)

There are some specifications for sensors that must be met to guarantee full functionality of the system.

We recommend a cable with 3 x 0.5 mm² for the sensor connection. The cables must be routed separately from power cables.

Spezification sensors and switches	
Feature	Description
Time delay before availability	≤ 70 ms
Current drain	As small as possible, 10 to 15 mA
Power supply	10 to 36 VDC
Dimensions	Length between 30 to 70 mm
Electrical connection	Open cable ends, no connector

Table

4: specifications sensors

Samples sensors						
OEM	Type	Output	M8 flush	M8 n. flush	M12 flush	M12 n. flush
IFM	PNP	NO	IE5121	–	IF5297	IF5329
IFM	PNP	NO	IE5072	–	IF5188	IF5249
IFM	NPN	NO	IE5123	–	IF5305	IF5337
IFM	NPN	NO	IE5082	–	IF5200	IF5251
IFM	PNP	NC	IE5122	–	IF5301	IF5333
IFM	PNP	NC	IE5078	–	IF5219	IF5250

Table 5: example list sensors

Ausgang

Öffner

Output

NC Normally Closed

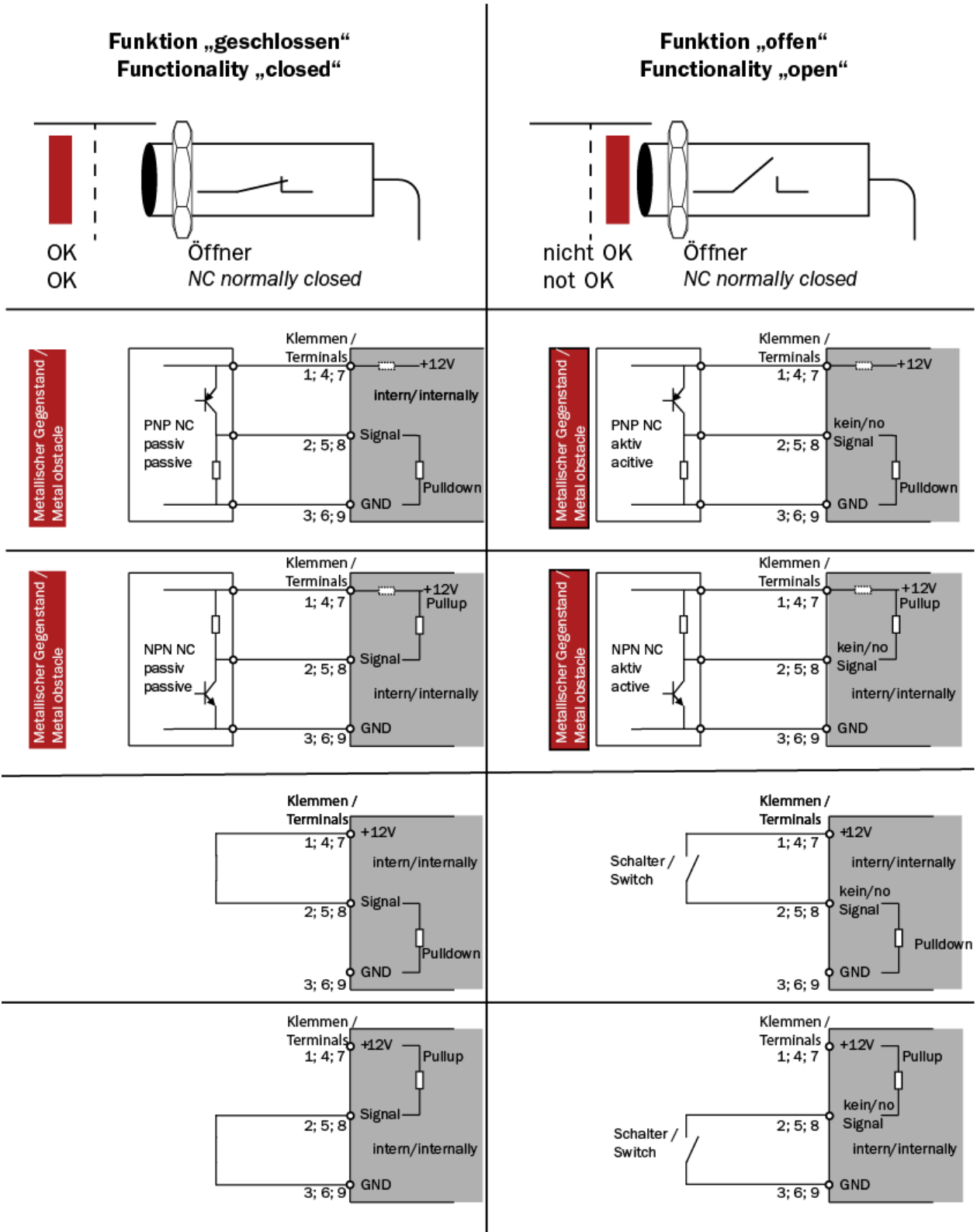

Figure 4: sensor connection Normally Closed

Ausgang

Schliesser

Output

NO Normally Open

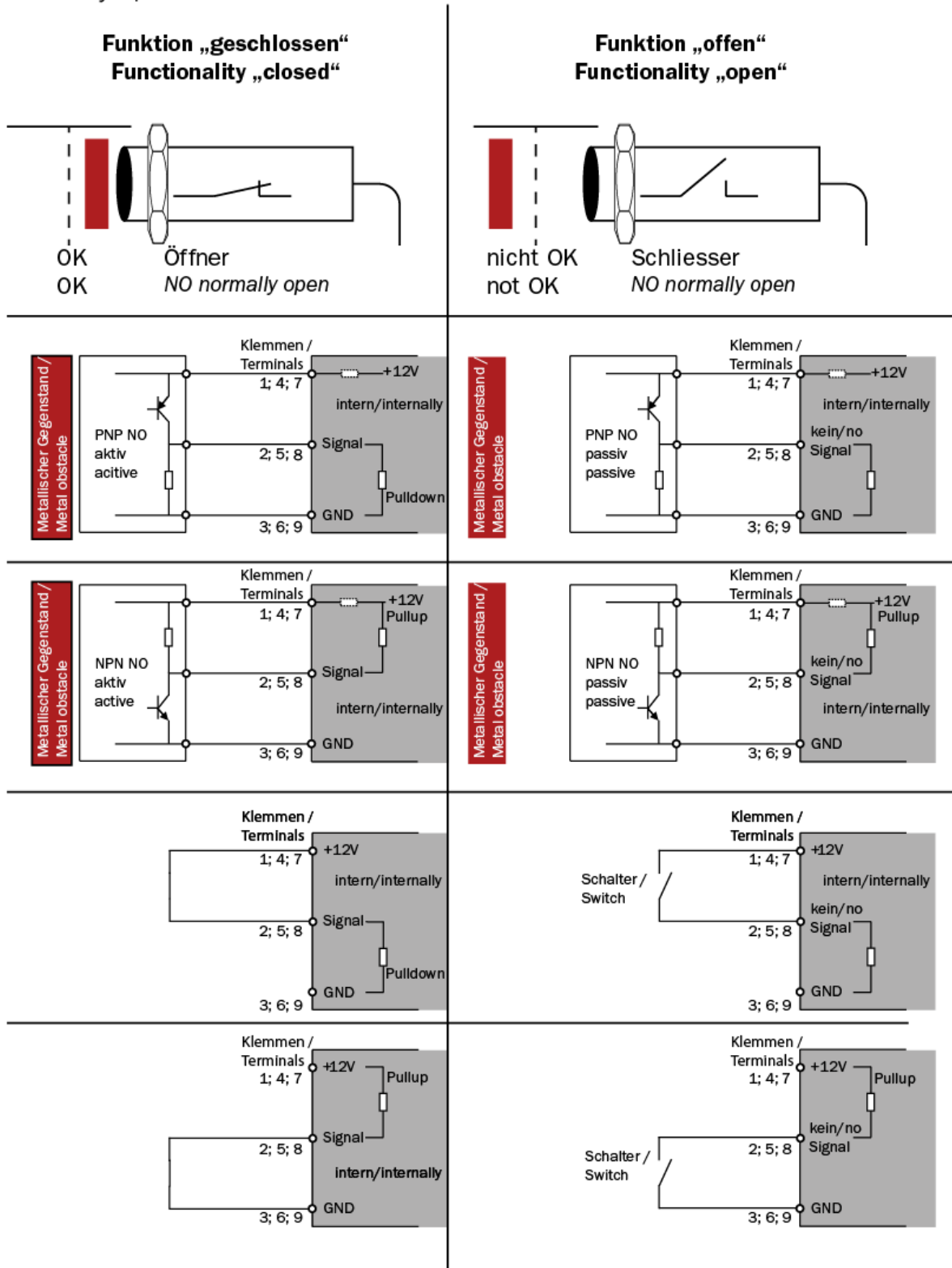

Figure 5: sensor connection Normally Open

4.5 Electrical Connection of the FMS-cradleGUARD.R Receiver Module

First, remove the cover from the front side of the component for the connection. The cover is secured with 4 countersunk-head screws.

We recommend a 3 x 0.5 mm² cable for the power supply. The cable must be routed separately from the power cable.

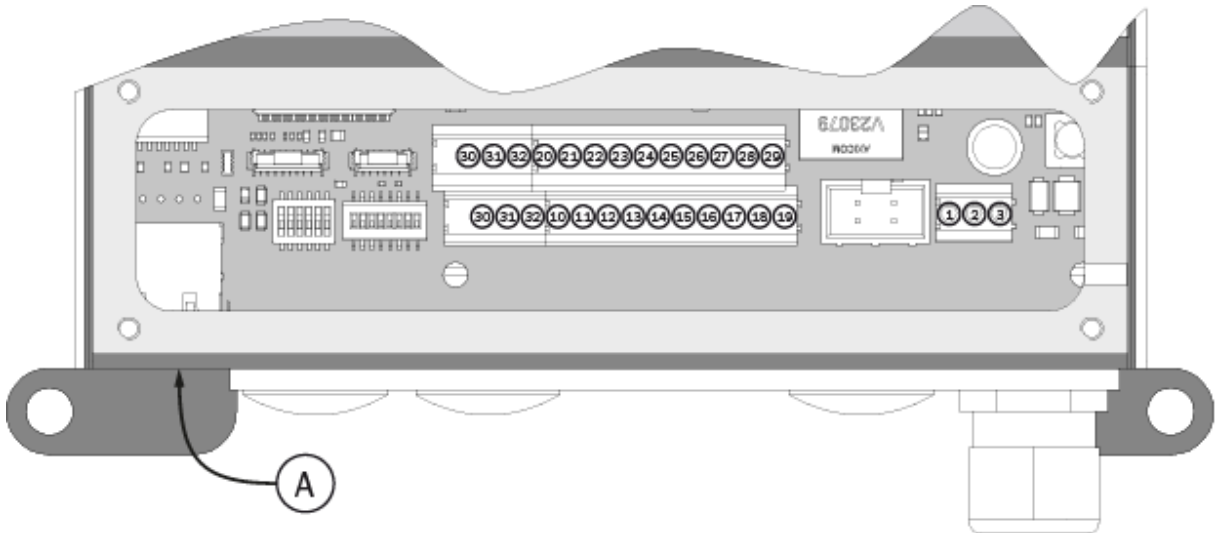

Figure 6: Electrical Connection of the FMS-cradleGUARD.R

Electrical connection of the FMS-cradleGUARD.R	
Item	Description
1	24 VDC (18 to 36 VDC)
2	GND
3	PE
16, 26	Relay 1/1 - 1/2
17, 27	Relay 2/1 - 2/2
18, 28	Relay 3/1 - 3/2
19, 29	Relay 4/1 - 4/2
A	RJ45 socket for Ethernet

Table 6: Electrical Connection of the FMS-cradleGUARD.R

5 Display and Operation

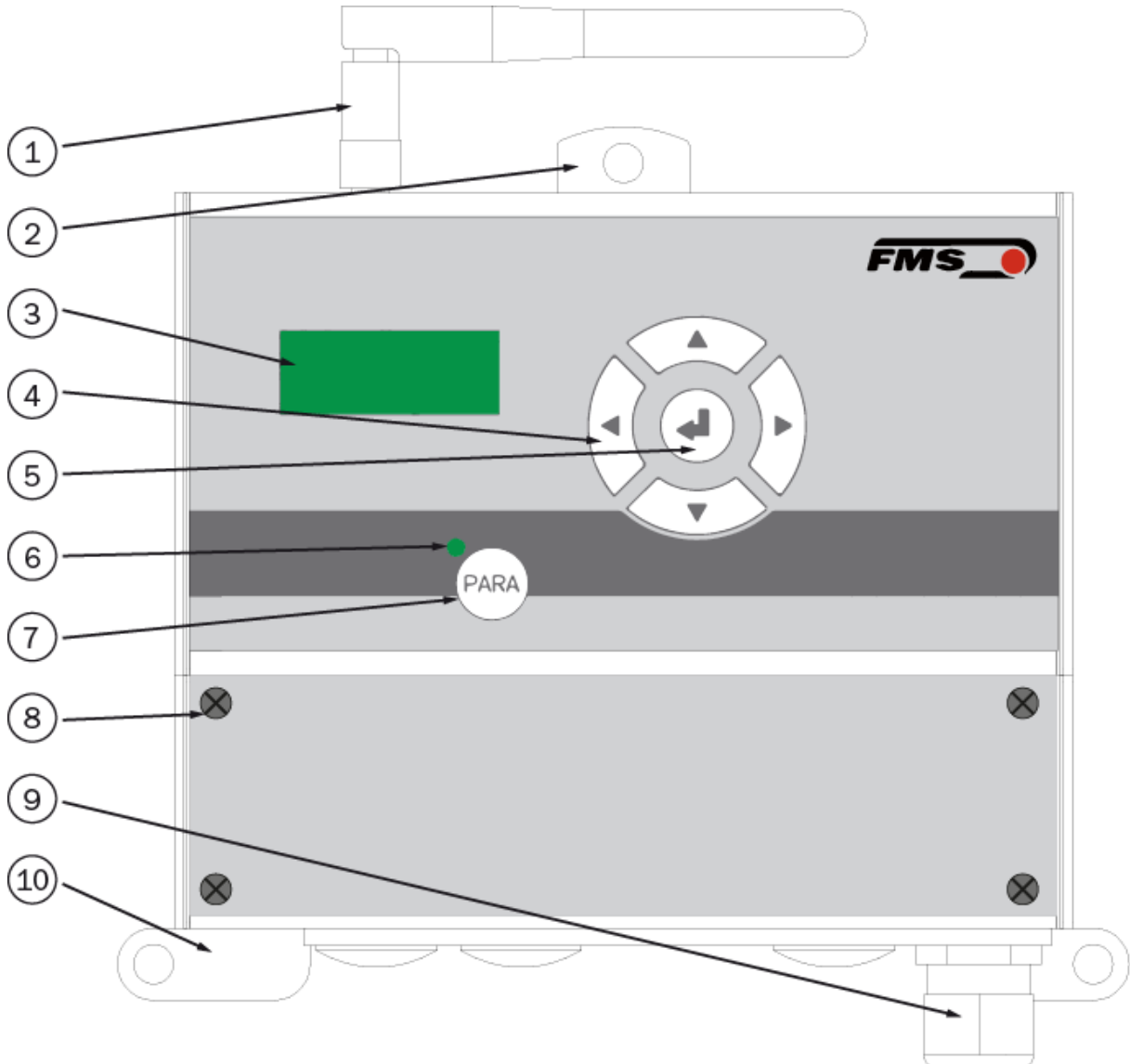

Figure 7: Control Panel and Display

FMS-cradleGUARD.R	
Item	Description
1	Antenna
2	Upper fastening lug
3	Display

FMS-cradleGUARD.R	
Item	Description
4	Navigation keys Left – Scroll parameter list to the left Right – Scroll parameter list to the right Up – Increase parameter value Down – Decrease parameter value
5	Enter key Select parameter, confirmation
6; 7	Menu key, status LED By pressing and holding the menu key (> 3 seconds), you can enter the configuration menu of the system parameters. The status LED lights up until you exit the menu by pressing and holding the menu key again (> 3 seconds).
8	Cover with 4 fastening screws
9	PG gland for cable feed-through (24 VDC)
10	Lower fastening lug

Table 7: FMS-cradleGUARD.R

5.1 Configuration on the Device

Only a basic parameter can be set on the device. The configuration itself has to be done via the web interface.

By pressing and holding the menu key (> 3 seconds), you can enter the menu of the system parameters.

- By pressing on the “left” and “right” keys, you can navigate through the parameter list.
- By pressing the enter key, you select the system parameter to be changed.
- Now, the name of the parameter to be changes is flashing
- By pressing the “up” and “down” keys, the parameter value can be changed.
- By pressing the enter key, you confirm your input and the changed value is saved.
- Press and hold the menu key again (>3 seconds) to exit the menu. If nothing is entered on the device, the menu is automatically exited after 60 seconds.

System Parameters	
Parameter	Description
IP address	<p>The IP address must be entered in 4 blocks.</p> <p>Min. 0</p> <p>Max. 255</p> <p>Default value 192.168.000.090</p>
Subnet	<p>The address must be entered in 4 blocks.</p> <p>Min. 0</p> <p>Max. 255</p> <p>Default value 255.255.255.0</p>
Gateway	<p>The address of the gateway must be entered in 4 blocks.</p> <p>Min. 0</p> <p>Max. 255</p> <p>Default value 255.255.255.0</p>
Language	<p>Display language on the device display</p> <p>Min. German</p> <p>Max. English</p> <p>Default value English</p>
CustomNa	<p>Customized designation of sensors</p> <p>Min. disabled</p> <p>Max. enabled</p> <p>Default value disabled</p>

System Parameters									
Parameter	Description								
T cycle	<p>Cycle time for communication between transmitter and receiving modules</p> <p>Cycle time «Auto»</p> <p>Here the cycle time is automatically reduced to 20 ms per transmitter module. E.g. with 8 connected and configured transmitter modules the cycle time is set to:</p> <p>8 x 20 ms = 160 ms</p> <table> <tr> <td>Min.</td> <td>Auto (only recommended when using the FMS-cradleGUARD.T.24VDC)</td> </tr> <tr> <td></td> <td>840 ms (only recommended when using the FMS-cradleGUARD.T.24VDC)</td> </tr> <tr> <td>Max.</td> <td>8400 ms</td> </tr> <tr> <td>Default value</td> <td>8400 ms</td> </tr> </table>	Min.	Auto (only recommended when using the FMS-cradleGUARD.T.24VDC)		840 ms (only recommended when using the FMS-cradleGUARD.T.24VDC)	Max.	8400 ms	Default value	8400 ms
Min.	Auto (only recommended when using the FMS-cradleGUARD.T.24VDC)								
	840 ms (only recommended when using the FMS-cradleGUARD.T.24VDC)								
Max.	8400 ms								
Default value	8400 ms								

Table 8: System Parameters

5.2 Display

If configured sensors or switches are activated this will be shown on the display.

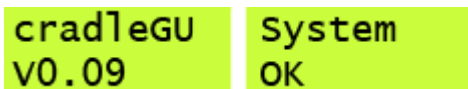

Figure 8: Display during start-up and without error

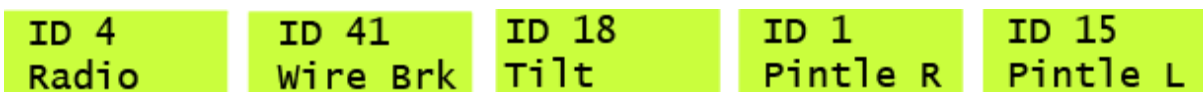

Figure 9: various error messages

Line 1 – individual ID of the transmission module FMS-cradleGUARD.T

Line 2 – specific error message

If multiple errors occur at the same time, the display will switch and indicate all errors in sequence.

5.3 Configuration via Web Interface

The system can be integrated in an Ethernet network and configured via a browser (e.g., Internet Explorer 8 or higher). The FMS-cradleGUARD.R receiver module has a static IP address, which can be set via the control panel. The IP address is not automatically obtained via DHCP.

Alternatively, the system can be configured using a desktop or laptop computer via a peer-to-peer connection. However, the computer must be disconnected from the network and have a static IP address for this purpose. The static IP address must not be identical with the IP address of the receiver module.

Follow the instructions as soon as the connection is established:

- Open a browser (e.g., Microsoft Internet Explorer, Mozilla Firefox, etc.)
- The default address of the receiver module is 192.168.000.090. If you have not change it, enter this IP address into the input field (e.g., http://192.168.000.090) and confirm with "Enter."



User interface language

The user interface of the browser is only available in English



Figure 10: Home

Web Interface – Home	
Item	Description
1	Main navigation

Table 9: Home

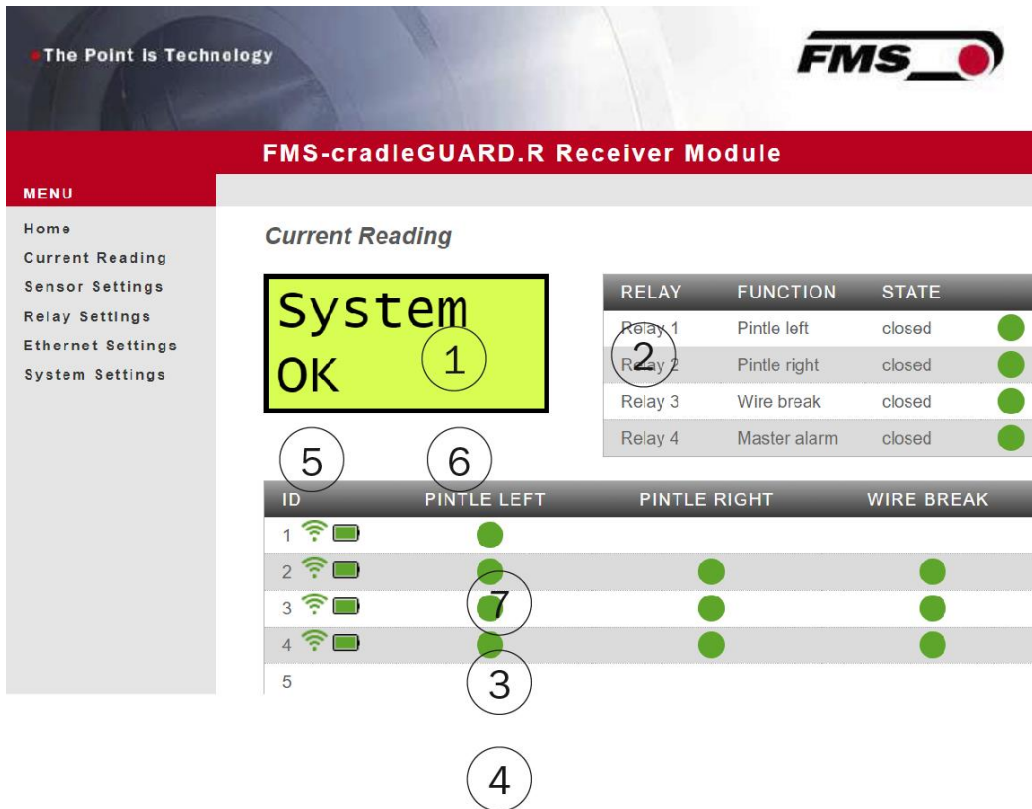

Figure 11: Current Reading

This a purely informative page only. You cannot edit anything.

Web Interface – Current Reading	
Item	Description
1	Information on the display
2	Status indicator for relay outputs
3	List of sensors 1 to 21
4	List of sensors 22 to 42 (not illustrated) Depending on the zoom factor of the browser window, the tables can also be arranged among each other.
5	Column “ID” (IDentification) Every FMS-cradleGUARD.T transmission module has its own ID number for easy assignment. The ID can be found on a sticker on the housing.
6	Column with sensor names Preset names Pintle left/right, wire break Names can be modified individually.
7	Sensor status Green - OK

Web Interface – Current Reading	
Item	Description
	Red - Fault

Table 12: Current Reading

The table always contains all available 42 transmission modules. Status messages are only displayed for the active transmission modules.

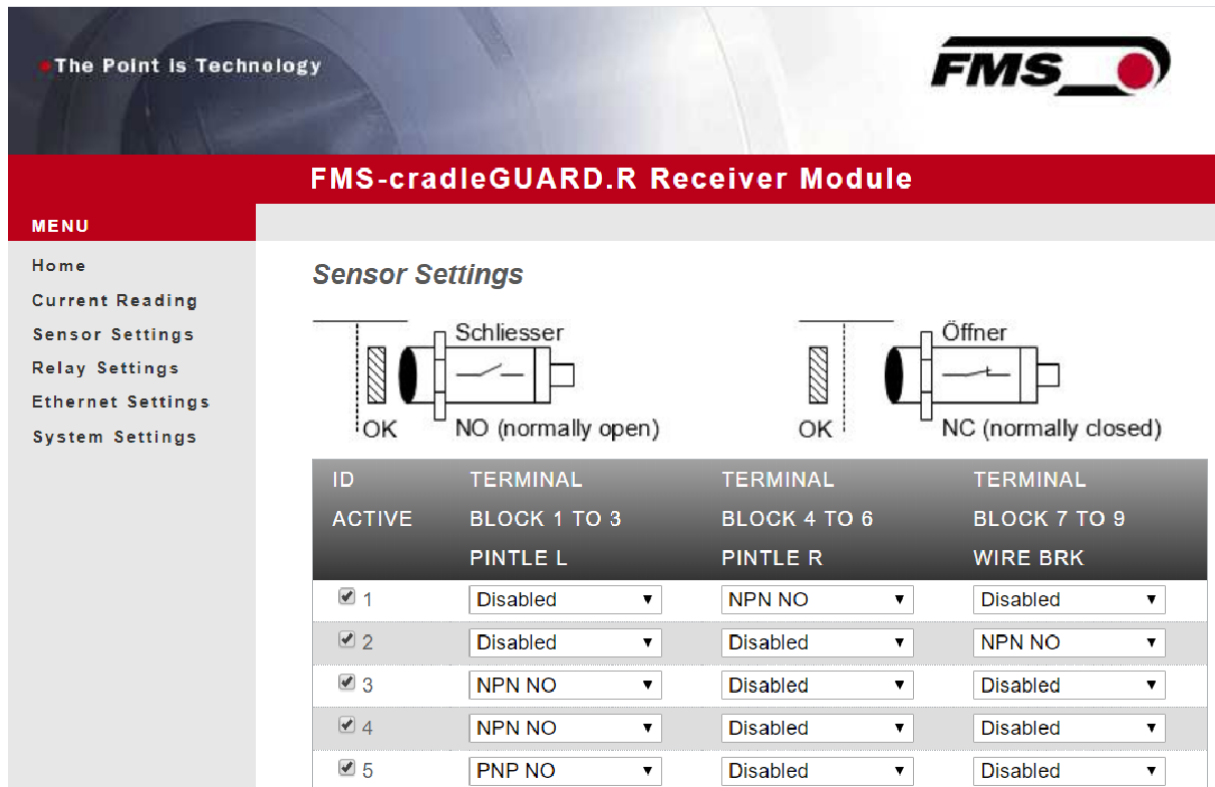

Figure 10: Sensor Settings

Web Interface – Sensor Settings	
Column	Description
ID ACTIVE	Using this checkbox, the transmission module with the respective ID is activated. As soon as it is activated, it appears in the “Current Reading” window.
Terminal Block 1 to 3 Pintle left	The individual columns stand for the 3 sensors that can be connected per transmission module. 5 different connection possibilities can be selected Deactivated - Disabled

Terminal Block 4 to 6 Pintle right	No sensor is connected. The sensor status is not shown on the display. Normally open
Terminal Block 7 to 9 Wire break / Tilt switch	PNP NO: Sensor switches the positive signal (+12 V) NPN NO: Sensor switches ground (GND) Normally closed PNP NC: Sensor switches the positive signal (+12 V) NPN NC: Sensor switches ground (GND)

Table 11: Sensor Settings



Save changes

If you made changes, you must confirm them using “Save changes.” Otherwise, your entries will be discarded once you leave the page!

You may have to scroll down on the page to see the save key.

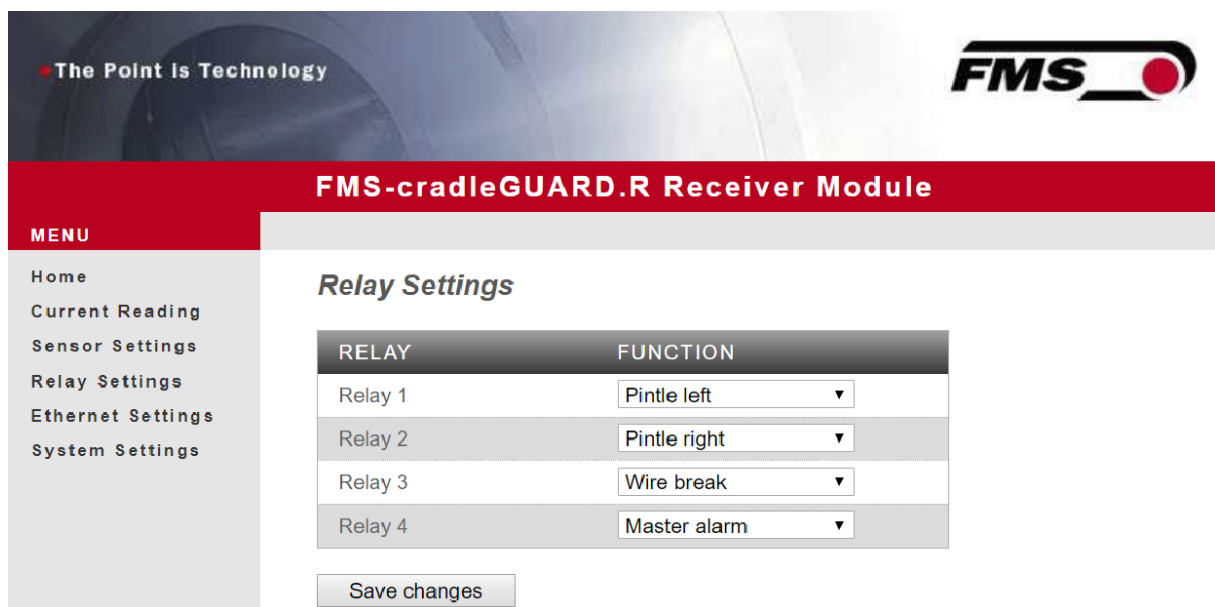

Figure 13: Relay Settings

You can define individual trigger conditions for the 4 relay outputs in the receiver module.

If you have set individual names for the switches, name in the list may vary from the names listed below in the table.

Web Interface – Relay Settings	
Function	Description
Disabled	Without function
Pintle left	If 2 pintles exist on the cradle, they can be differentiated

Web Interface – Relay Settings	
Function	Description
Pintle right	here.
Wire Break	Detection of a wire break using the respective sensor. The response time until relay triggering can be up to 8.4 seconds.
Tilt	Is mainly used for tubular type stranders and to detect cradle swinging.
Radio lost	The quality of the radio connection of the individual transmission modules is checked continuously. A relay can be switched in the case of a poor connection.
Battery low	Is activated if the charging status of the battery drops below 5%. A runtime of a few days is left prior to battery replacement. This alarm does not affect the Master alarm.
Master alarm	Is activated as soon as any fault state occurs, regardless of the configuration of other relay outputs.

Table 12: Relay Settings



Save changes

If you made changes, you must confirm them using "Save changes." Otherwise, your entries will be discarded once you leave the page!



Recommendation for Alarms

We recommend to select **at least the "Master alarm" and "Battery low" for the relay outputs**. The output of the "Master alarm" should be directly connected to the PLC to stop the machine in case of any alarm condition. The "Batter low" output can be connected to an indication light to remind the operator of changing the empty battery during the next production stop.

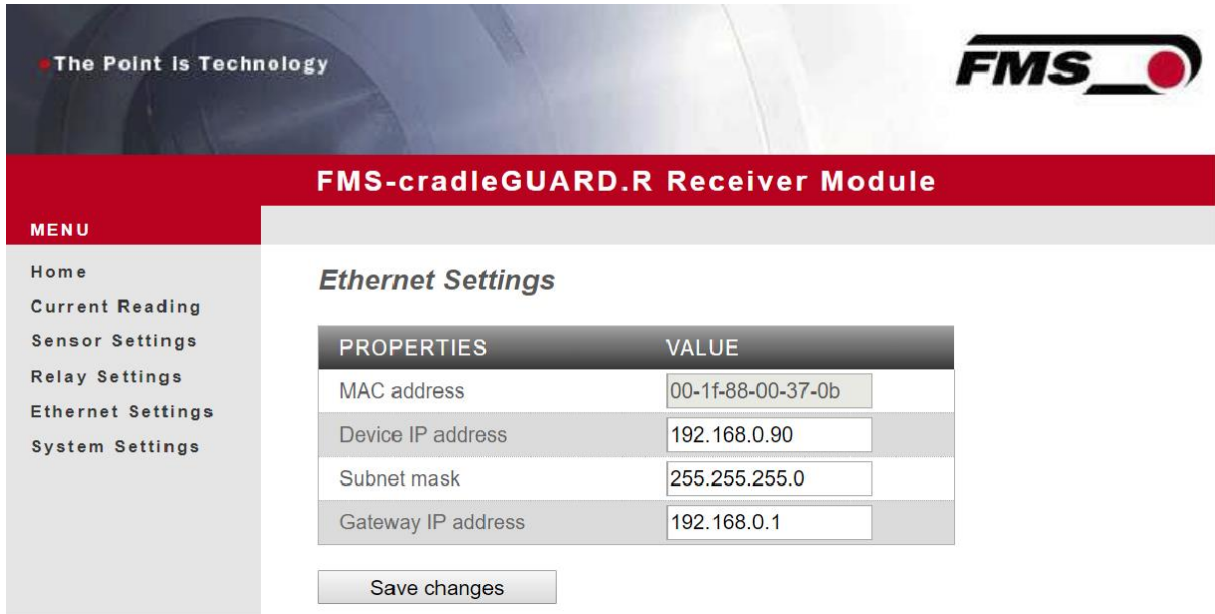

Figure 14: Ethernet Settings



Save changes

If you made changes, you must confirm them using “Save changes.” Otherwise, your entries will be discarded once you leave the page!

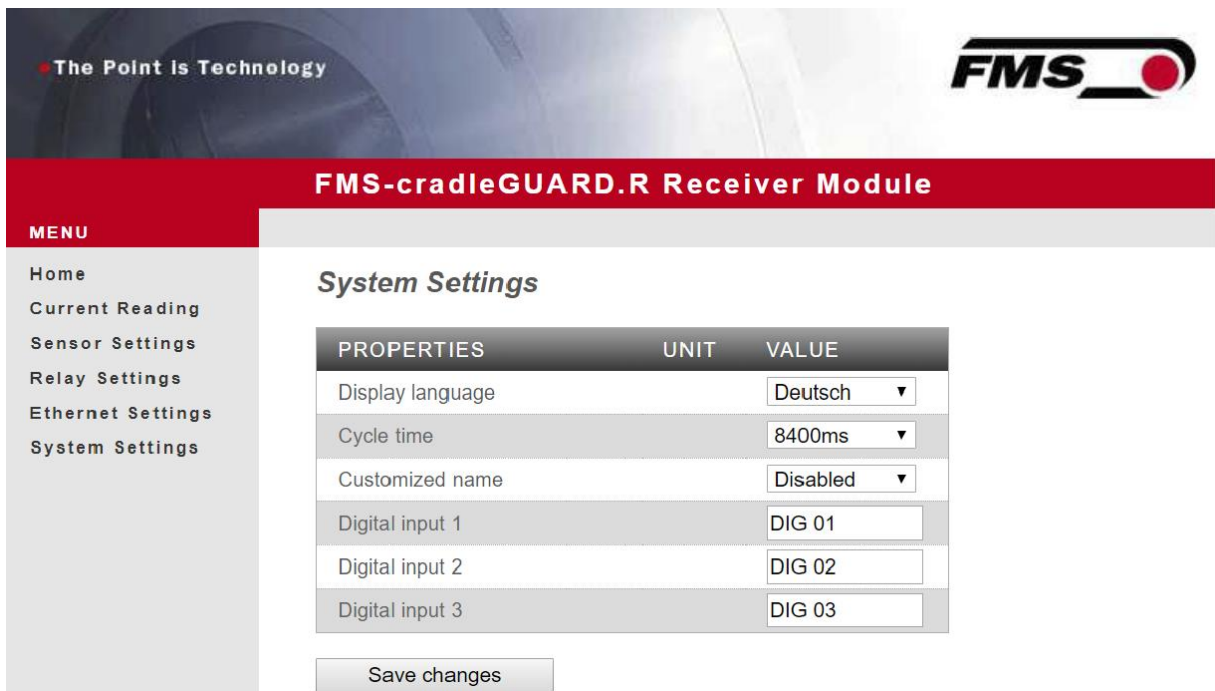

Figure 15: System Settings



Saving changes

If you made changes, you must confirm them using “Save changes.” Otherwise, your entries will be discarded once you leave the page!

Web Interface – System settings	
Function	Description
Display language	Language in the display of the receiving module in German or English
Cycle time	<p>Communication cycle time between transmitting and receiving modules.</p> <p>The minimum cycle time of 840 ms is only recommended in combination with the FMS-cradleGUARD.T.24VDC.</p> <p>The setting “Auto” is only recommended in combination with the FMS-cradleGUARD.T.24VDC.</p>
Customized name	Enabling this field will show the individual names for the sensors of the fields Digital input 1 to 3 in the display of the receiving module as well as in the web browser.
Digital input 1	Free designation of sensor names.
Digital input 2	Maximum of 8 digits
Digital input 3	

Table 13: System Settings

6 Technical Data

6.1 FMS-cradleGUARD.R Receiver Module

FMS-cradleGUARD.R technical data	
Property	Description
Display	LCD 2 x 8 characters (5 mm)
Propagation delay	8.4 sec, 840 ms, Auto (20 ms per transmitter module)
Interface	Ethernet via web interface (Internet Explorer 8 or higher)
Radio interface	2.44 GHz
Relay outputs	4 relay contacts DC: 24 V, /0.5 A/12 W; AC: 24 V/0.5 A/62.12 VA
Power supply	24 VDC (18 to 36 VDC) / 10 W (max. 0.5 A)
Temperature range	0 to 50 °C (32 to 122 F)
Protection rating	IP52
Weight	0.65 kg (1.43 lb)

Table 14: FMS-cradleGUARD.R technical data

6.2 FMS-cradleGUARD.T Transmission Module

FMS-cradleGUARD.T technical data	
Property	Description
Power supply	Industrial, rechargeable battery, 12 VDC, 3 Ah Optional with FMS-cradleGUARD.T.24VDC for existing 24 VDC (18 to 36 VDC) power supply from machine.
Power supply to sensors	12 VDC
Radio interface	2.44 GHz
Protection rating	IP65
Weight	0.8 kg

Table 15: FMS-cradleGUARD.T technical data

6.3 Certifications

FMS-cradleGUARD certifications	
Certificate	Description
ETSI Radio Certification	Certification to follow
FCC Certification USA, Canada	Certification to follow

Table 16: Certifications

7 Dimensions

7.1 FMS-cradleGUARD.R Receiver Module

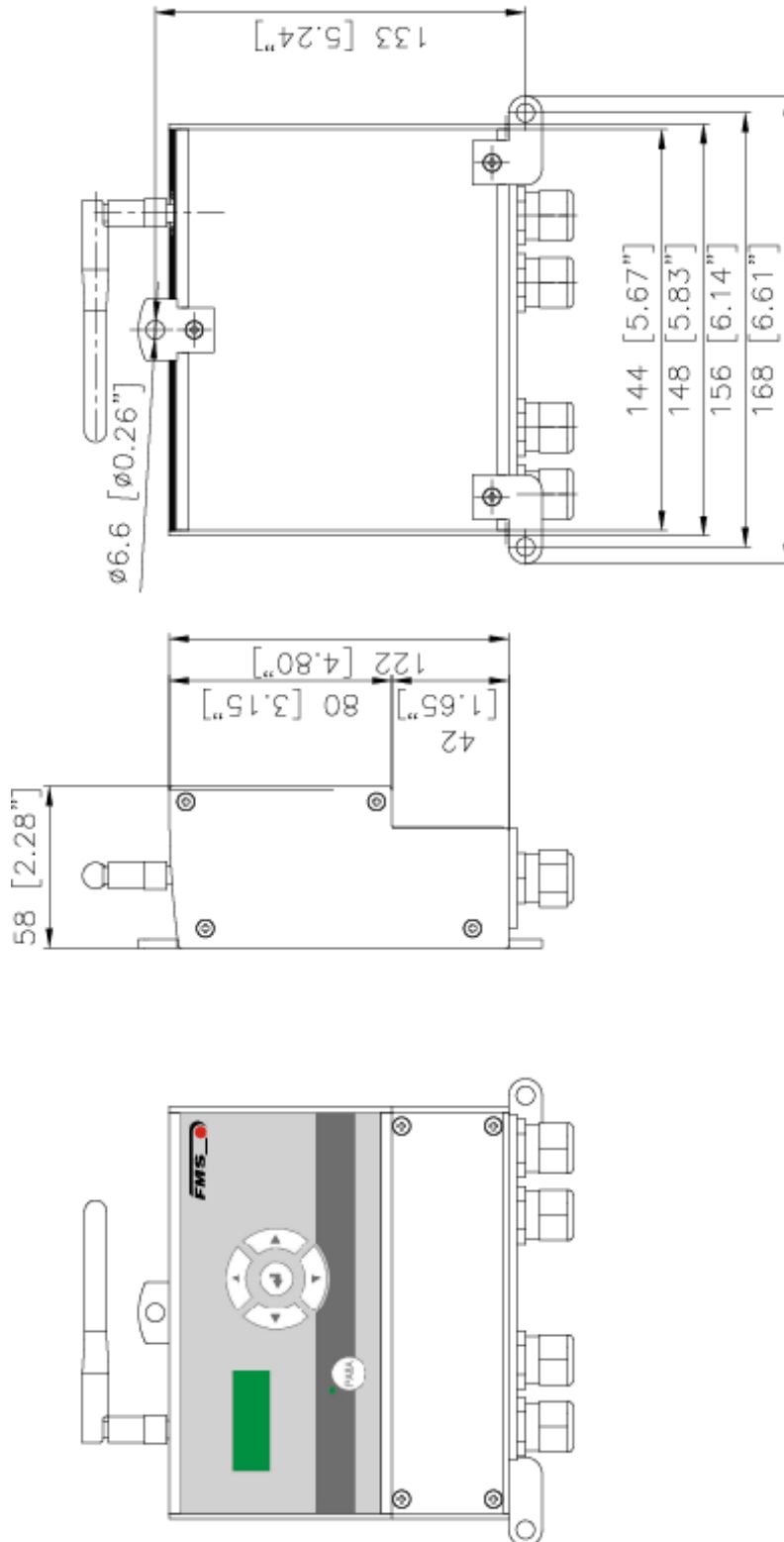

Figure 16: FMS-cradleGUARD.R Receiver Module Dimensions

7.2 FMS-cradleGUARD.T Transmission Module

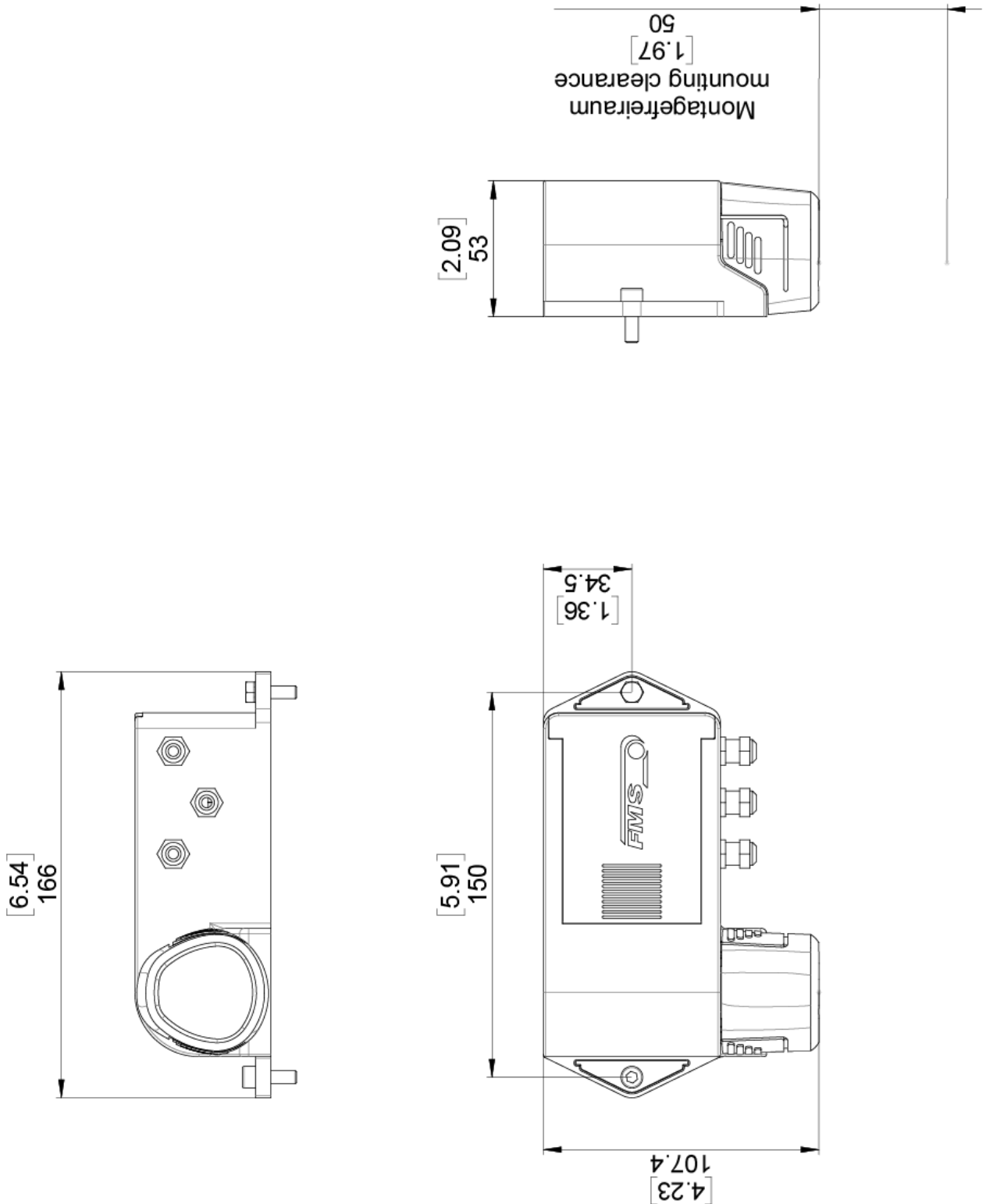

Figure 17: FMS-cradleGUARD.T Transmission Module Dimensions

7.3 FMS-cradleGUARD.T.24VDC Transmission Module

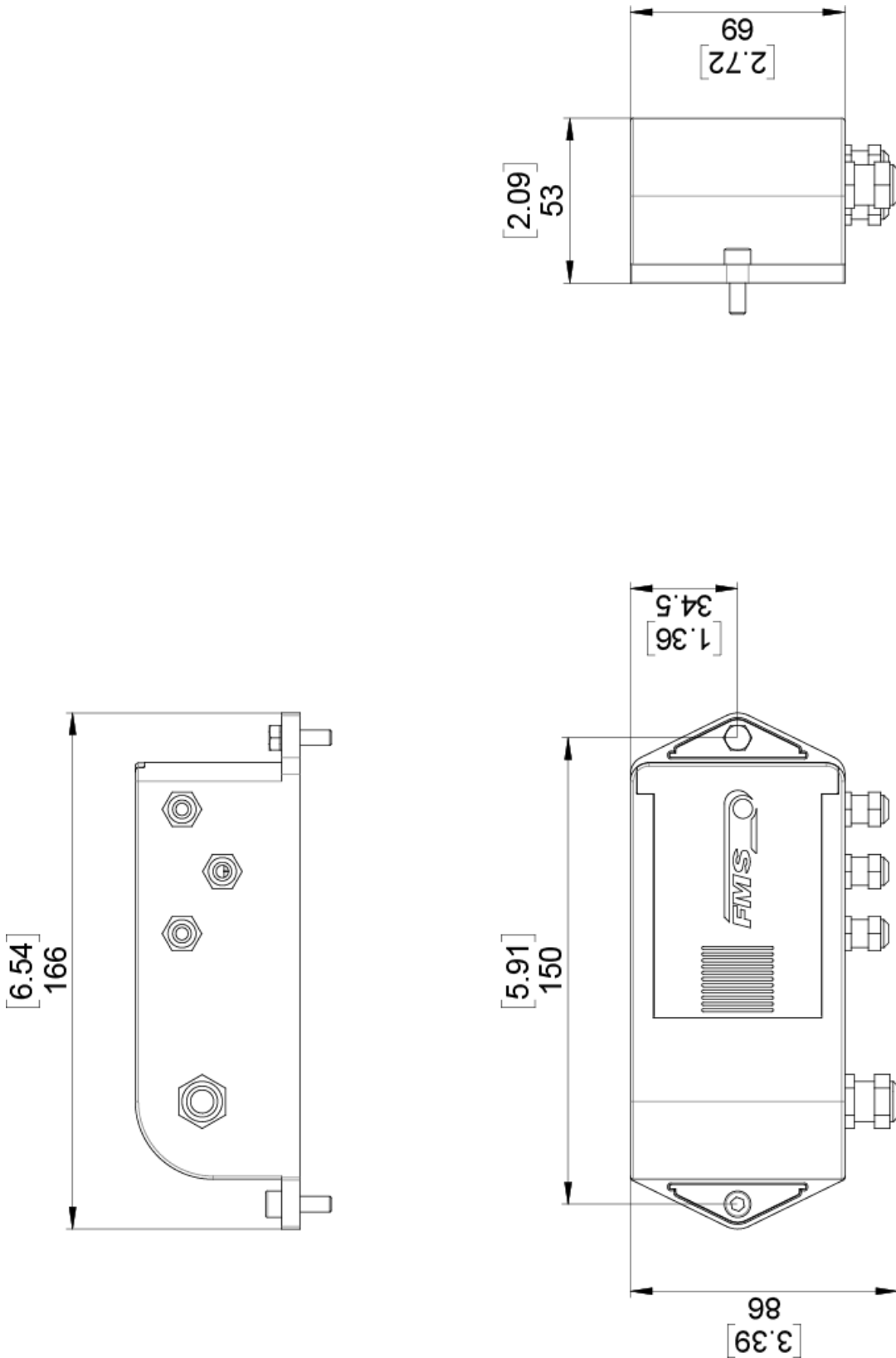

Figure 18: FMS-cradleGUARD.T Transmission Module Dimensions

8 Troubleshooting, FAQ

Errors and solutions	
Error pattern	Cause and correction
Connection lost from PC to receiver module	Patch cable → Check cable, check plug connections
Connection lost to transmission module(s)	Battery empty → Replace battery Radio transmission faulty → Objects block transmission path
Short battery life	Reduced capacity due to aged batteries → exchange batteries
Fault indicated although sensor connected	Sensor dirty or incorrect installation position prevents activation. Sensor configured as “NPN” instead of “PNP”, or vice versa. Change configuration under Sensor Settings.

Table 17: Troubleshooting, FAQ



FMS Force Measuring Systems AG
Aspstrasse 6
8154 Oberglatt (Switzerland)
Tel. 0041 1 852 80 80
info@fms-technology.com
www.fms-technology.com

FMS USA, Inc.
2155 Stonington Avenue Suite 119
Hoffman Estates, IL 60169 (USA)
Tel. +1 847 519 4400
fmsusa@fms-technology.com