

FMS Telemetry Systems

RTM MP Plus Compact, wireless signal transmission for rotating machinery

- Reliable signal transmission - without slip-rings**
 Certified radio transmission in the 2.44 GHz band, encoder signals up to 100 kHz
- For many applications**
 Typical signals on retrofit of a buncher/twister: encoder, analogue, digital and force sensor signal
- Easy to retrofit**
 Plug-and-play with prefabricated cables and connectors
- Compact dimensions**
 Small transmitting module for the rotating part of the machine, protect, internal antenna

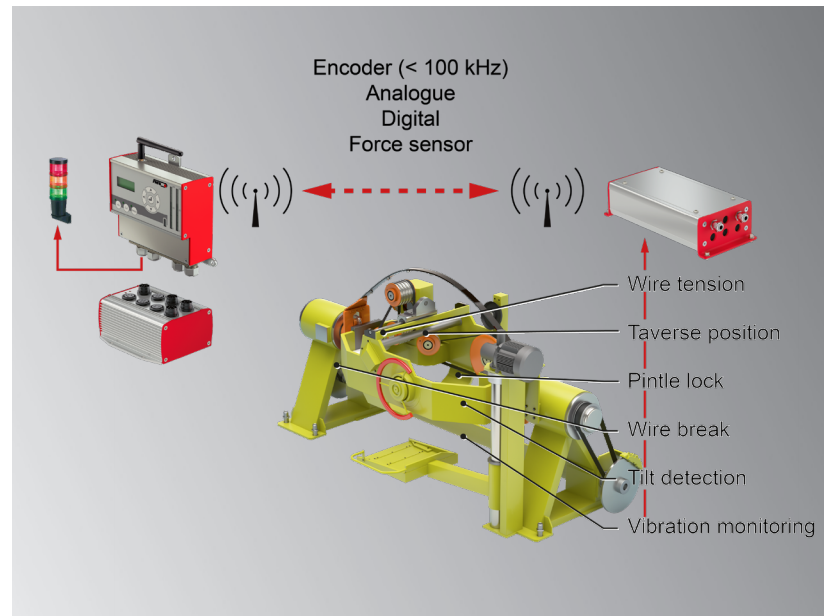

RTM MP Plus Signal Transmission

The RTM MP Plus Telemetry System was developed for transmitting various signals in parallel from rotating machinery:

- 2 x Encoder
- 8 x Digital
- 1 x Analog
- 2 x Force sensor

The RTM MP Plus System is applied where signal transmission utilizing slip rings is no longer practical. The costs involved for an expansion or and upgrade of existing slip ring signal transmission can be substantial due to the complexity of the required components or modifications to the machine itself.

Many RTM MP Plus Systems are applied as a substitute for defective or aged slip-ring systems where the repairs are cost prohibitive or even impossible as spare parts are no longer available. Through the use of robust components for maintenance free operation and a simple system concept for easy installation, the RTM MP Plus System provides the telemetry solution of choice for the installed base of buncher and twister stranding machines.

Funktionsbeschreibung

The RTM MP Plus System consists of only three main components: One transceiver inside the rotating part of the machine, and both one transceiver and one decoding module on the outside of the machine, normally mounted near the operator's station. The transceiver located inside the rotating part of the machine is connected via cabling to each of the signal sources. Process signals can be sent in both directions between the rotating and static parts of the machine. The real time data transmission between the two transceivers is highly reliable, stable and insensitive to radio disturbances or other RTM MP Systems operating within close proximity. The decoding module on the static side is responsible for the data processing and serves as the link to the PLC or other controllers.

The main difference between the RTM MP and the RTM MP Plus system concerns the components inside the rotating part of the machine. There is no decoding module required and the housing is much more compact. An internal antenna is installed. The RTM MP system can be extended, the RTM MP Plus cannot be extended.

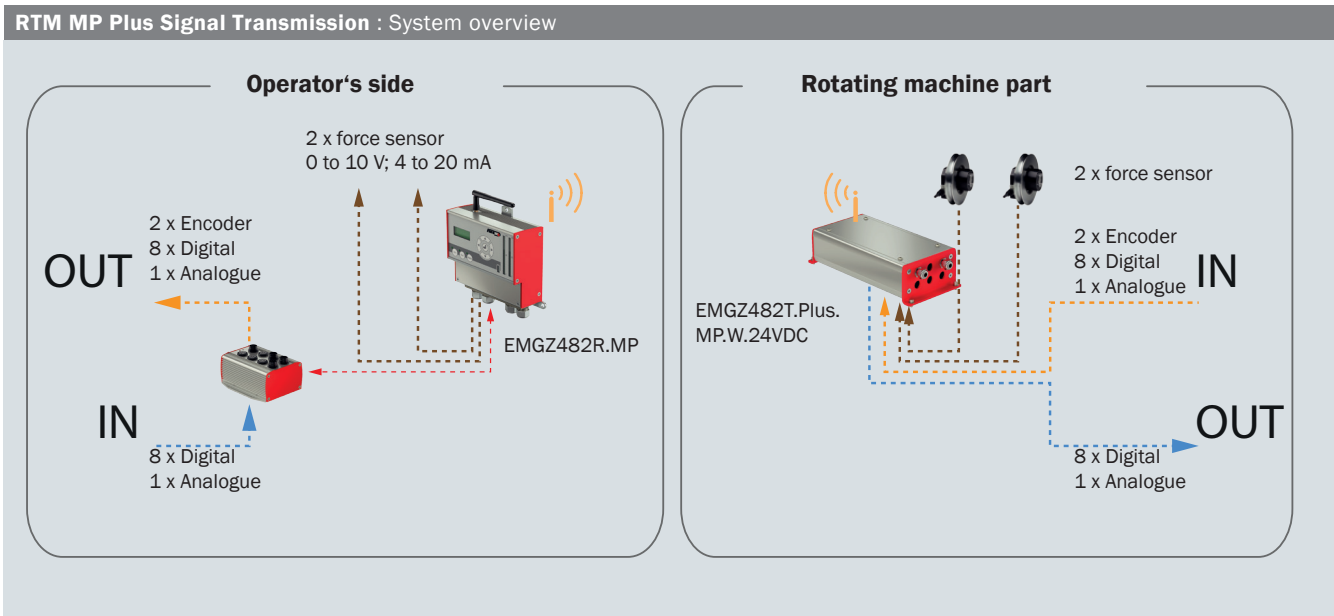

RTM MP Plus Signal Transmission : Main Components

**RTM MP Plus Transceiver
EMGZ482T.PLUS**

located within the rotating machine section

**RTM MP Plus Sender/Empfänger
EMGZ482R.MP**

located near the operator's station

**RTM MP Plus Decoding Module
EMGZ443.MP.R**

located near the operator's station



- Compact dimensions
- Single housing with integrated antenna
- Inputs
 - 2 x Encoder
 - 1 x Analog
 - 8 x Digital
 - 2 x Force sensor
- Outputs
 - 1 x Analog
 - 8 x Digital
- Integrated measuring amplifiers for the force sensors
- Directly connected to 24 VDC power supply of machine

- Outputs
 - 2 x Analog (from force sensors)
- Interface to decoding module

- Outputs
 - 2 x Encoder
 - 1 x Analog
 - 8 x Digital
- Inputs
 - 1 x Analog
 - 8 x Digital

RTM MP Plus transceiver (rotating section) EMGZ 482T.PLUS : Technical Data

| | |
|---------------------------------|--|
| Encoder inputs | 2 channels max. 100 kHz |
| Analog input | 0 to 10 VDC or 4 to 20 mA |
| Force sensor inputs | 2 sensors with strain gauges @ 350 Ω (0 to 5.4 mV, max. 7.4 mV) |
| Digital input | 8 x; 5 to 36 VDC |
| Digital output | 8 x; max. 100 mA / output (source) |
| Analog output | 0 to 10 VDC and 4 to 20 mA |
| Wireless interface | 2.44 GHz |
| Encoder supply | HTL (15...30 VDC; max. 2 W) |
| Sensor supply | 3.0 VDC, max. 20 mA, highly stable |
| Power supply | 24 VDC (18 to 36 VDC / 10 W max. 0.5 A) |
| Resolution A/D-converter | \pm 8192 Digit (14 Bit) |
| Measuring error | < 0.05 % FS |
| Temperature range | 0 to 50 °C [32 to 122 °F] |
| Protection class | IP 52 |
| Weight | 1.50 kg (3.3 lbs.) |

RTM MP Plus Transceiver (operator's station) EMGZ 482R.MP : Technical Data

| | |
|----------------------------------|--|
| Force sensor outputs | 2 x 0 to 10 VDC or 4 to 20 mA |
| Relay output (radio lost) | 1 relay contact; DC: 24 V / 0.5 A / 12 W; AC: 24 V / 0.5 A / 62.12 VA |
| Displays | LCD 2 x 8 digits, 5 mm(0.2 in.), 2 LED rows for tension indication Supply voltage indicator |
| Wireless interface | 2.44 GHz |
| Power supply | 24 VDC (18 to 36 VDC) / 10 W (max. 0.5 A) |
| Propagation delay | 5.5 ms |
| Resolution D/A-converter | 0 to 4096 (12 Bit) |
| Temperature range | 0 to 50 °C [32 to 122 °F] |
| Protection class | IP 52 |
| Weight | 0.52 kg (1.15 lbs.) |

RTM MP Plus Decoding Module EMGZ 443MP.R : Technical Data

| | |
|--------------------------|--|
| Encoder outputs | 2 channels max. 100 kHz |
| Analogue outputs | 0 to 10 VDC or 4 to 20 mA |
| Digital outputs | 8 outputs; max. 100 mA / output (source) |
| Digital inputs | Digital inputs 5 to 36 VDC |
| Analog input | 0 to 10 VDC or 4 to 20 mA |
| Power supply | 24 VDC (18 to 36 VDC) max. 0.4 A |
| Power consumption | max. 15 W |
| Temperature range | 0 to 50 °C [32 to 122 °F] |
| Protection class | IP52 |
| Weight | 0.45 kg (1.0 lbs.) |

Radio Certification ETSI

| | |
|-------------------------------------|--|
| Magnitude of Test (Coverage) | Article 3.2 of Directive 1999/5/EC (R & TTE Directive) |
| Certification | ETSI EN 300 440-2 V1.5.1 (2009-03); ETSI EN 300 440-1 V1.3.1 (2009-03) |

FCC Certification : USA, Canada

| | |
|-----------------------|--|
| Testumfang | Class A digital device, pursuant to Part 15 of the FCC Rules |
| Zertifizierung | FCC Registration #: 0020311882 |

CAB Funk-Zertifizierung : Japan

| | |
|-------------------------------------|--|
| Magnitude of Test (Coverage) | Low power data communi. FXD; Art. 38 -24, Paragraph 1 of radio law |
| Certification | Article 2, Clause 1 Item 19, Certification ID #: 202WWSM10126721 |

Lloyd's Register Zertifizierung

| | |
|-------------------------------------|---|
| Magnitude of Test (Coverage) | Appraisal Document No. HTS/ETS 37656-18 Certification |
| Certification | Lloyd's Register Type Approval Certificate No. 18/20083 |



RTM MP Plus Transceiver (rotating section) EMGZ 482T.PLUS : Dimensions in mm (in)

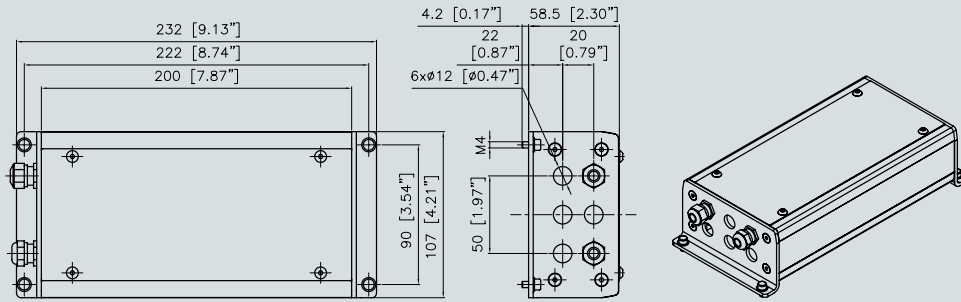

RTM MP Plus Transceiver (operator's station) EMGZ 482R.MP.R : Dimension in mm (in)

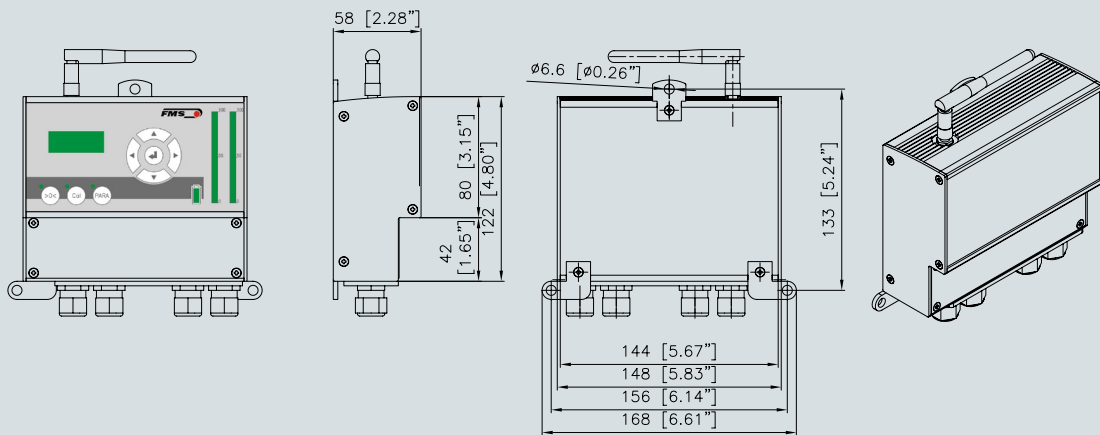

RTM MP Plus Decoding Module (operator's station) EMGZ443.MP : Dimensions in mm (in)

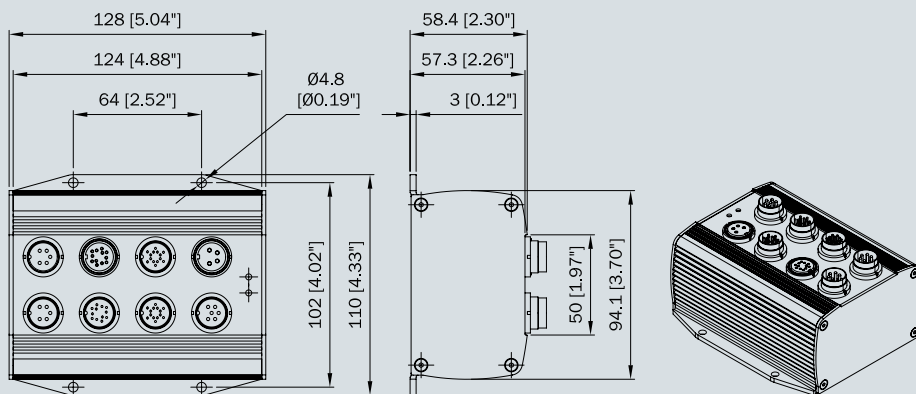

| RTM MP Plus : Options | |
|--|---|
| Cable lengths | Standard cable sets are available in 1.5 m (5 ft) or 5 m (16 ft) |
| Installation and start-up | Our specialst are available upon request |
| RTM MP Plus : Accessories | |
| Force sensors | We will be pleased to advise you on the selection of suitable force sensors for strand tension monitoring |
| Pulleys / sheeves for force sensors | Upon request we can provide design and production |

Telemetry Systems : Other solutions for the wire & cable industry

RTM X42 : Strand tension monitoring and control

- Modular system, easy to retrofit to existing stranding machines
- Fully automated monitoring
- Data display, recipe management and quality protocols with own software
- Uninterrupted, closed-loop strand tension control

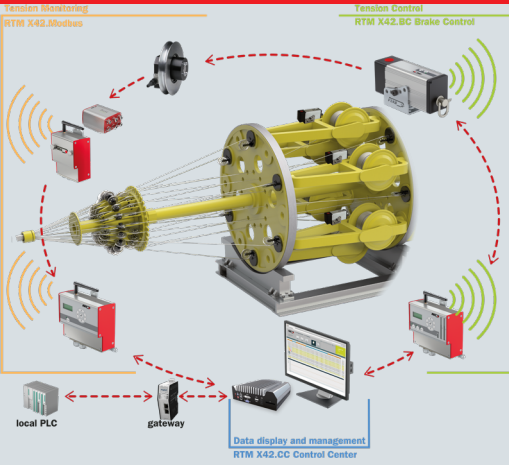

RTM 10 : Strand tension monitoring up to 10 strands

- Straightforward system for easy retrofit to existing stranding machines
- Fully automated monitoring
- Simple LCD for tenison values of the 10 channels
- Analogue outputs all channels for further processing, e.g. within the local PLC.

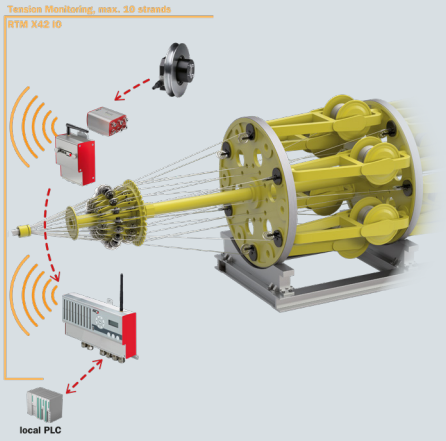

FMS-cradleGUARD : Reliable safety-monitoring of all cradles

- Improved machine safety
- Fast troubleshooting, short downtimes
- Easy to retrofit
- Universally applicable, up to 42 cradles

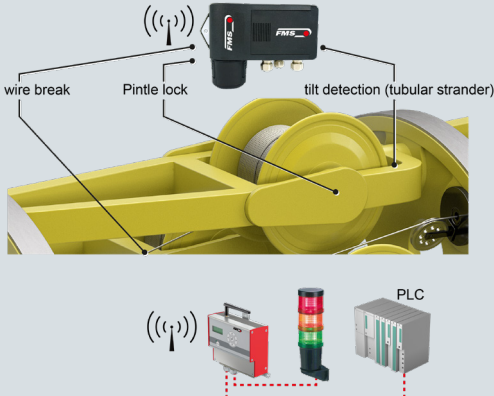



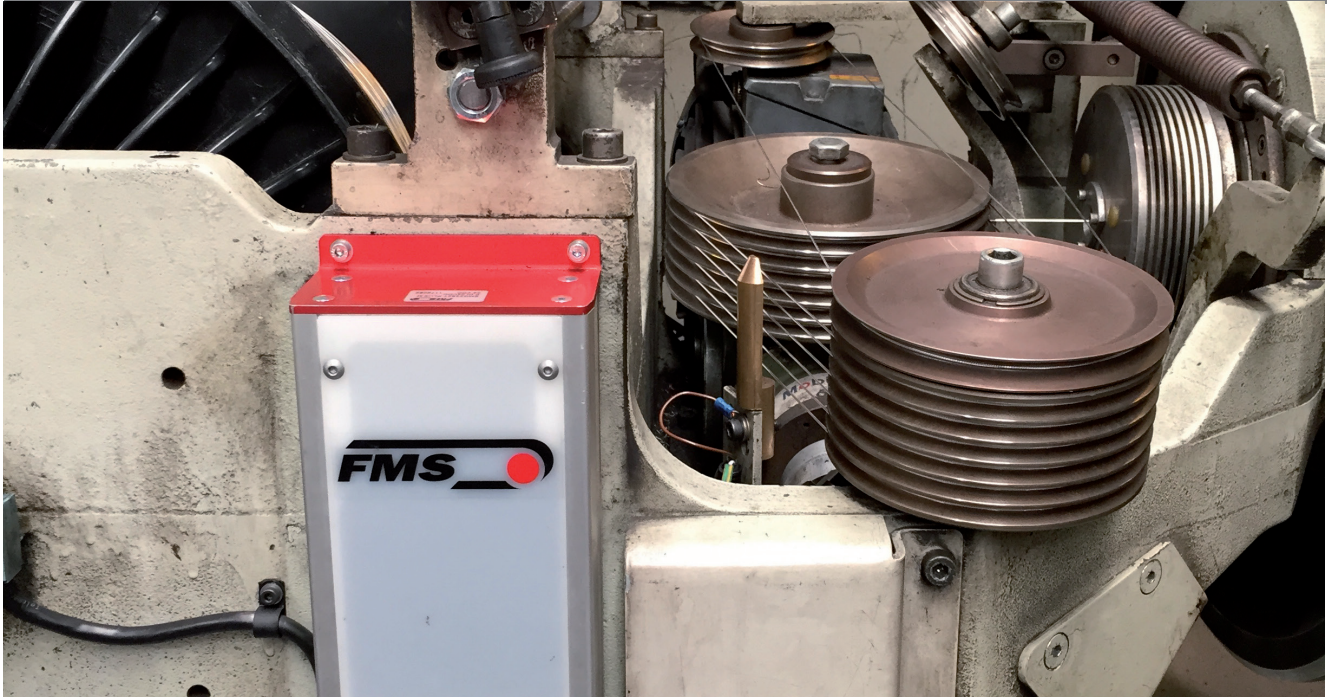

RTM MP Plus : Typical application in buncher / twister



Other FMS products for the Wire & Cable Industry

FMS offers a wide range of measuring sensors that can be used in combination with our telemetry systems. With numerous styles and available load ratings from 3 to 8000 N, it is likely that we can provide a solution for your application. FMS measuring amplifiers and tension controllers are applicable when wireless data transmission is not required or when wiring of the components is not an issue. You can rely on our years of experience and proven technology in this field. Contact us directly to learn how we are able to assist you with your application..

Other products : Accessories

| RMGZ200 | RMGZ300 | Measuring amplifiers | Tension controllers |
|---|---|--|---|
|  |  |  |  |

About us

FMS Force Measuring Systems AG is the market leader in the field of web tension measurement, control and specialist for web guiding solutions. For the wire industry we are the only manufacturer offering a complete range of technologies for force measurement, data processing and radio transmission of signals.

Our in house developed products are used in the manufacturing industry, converting, metals, paper, textiles, as well as in cable and wire rope production. Utilising the latest technology, high quality components and a firm understanding of customer applications, FMS supports customers worldwide in the effort to maximize the productivity of their machines. Since 1993, our highly qualified employees have been creating high-end solutions for machine builders and plant operators. As an owner-managed company, we pride ourselves on being personal and approachable with the ability to make decisive moves fast.

World Headquarters: FMS Force Measuring Systems AG

Aspstrasse 6 • 8154 Oberglatt (Switzerland) • Phone + 41 44 852 80 80 • Fax + 41 44 850 60 06
 info@fms-technology.com • www.fms-technology.com

Alle Angaben wurden sorgfältig erstellt und überprüft. Für eventuelle Fehler oder Unvollständigkeiten können wir jedoch keine Haftung übernehmen. Änderungen, die dem Fortschritt dienen, behalten wir uns vor./003