



Installation Instruction UMGZ

Standard force measuring block

Document version 4.10

Issue date / Author 03/2021 NS



Diese Montageanleitung ist auch in Deutsch erhältlich.

Bitte kontaktieren Sie Ihre FMS Vertretung.

1 Table of contents

1	TABLE OF CONTENTS	2
2	SAFETY INSTRUCTIONS.....	3
2.1	Presentation of safety information	3
2.1.1	Danger that could result in minor or moderate injuries.....	3
2.1.2	Note regarding proper function	3
2.2	General safety information	3
3	PRODUCT INFORMATION.....	4
3.1	Product description	4
3.2	Functional description	4
3.3	System arrangement.....	4
3.3.1	Vertical measuring block.....	5
3.3.2	Horizontal measuring block	6
3.4	Scope of delivery.....	7
3.5	Order code	7
4	INSTALLATION.....	8
4.1	Installation conditions.....	8
4.2	Preparing the machine frame.....	8
4.3	Electrical connections	9
5	TECHNICAL DATA	10
6	DIMENSIONS IN MM (IN.)	11

2 Safety instructions

All safety related regulations, local codes and instructions that appear in the manual or on equipment must be observed to ensure personal safety and to prevent damage to the equipment connected to it. If equipment is used in a manner not specified by the manufacturer, the protection provided by the equipment may be impaired.

Do not stress the equipment over the specification limits neither during assembly nor operation. To do so can be potentially harmful to persons or equipment in the event of a fault to the equipment.

2.1 Presentation of safety information

The following safety symbols appear in this manual.

2.1.1 Danger that could result in minor or moderate injuries



Danger, warning, caution

Failure to follow wiring instructions in this manual may result in equipment damage or personal injury.

2.1.2 Note regarding proper function



Note

Note regarding proper operation
Simplification of operation
Ensuring function

2.2 General safety information



The force sensors may not be stressed over the specification limits neither during assembly nor operation. The unit's overload protection value may not be exceeded.



The attachment points for the force sensors on the machine frame must be properly designed. The pillow blocks need to be appropriately mounted.

3 Product information

3.1 Product description

The force sensors of the UMGZ-Series, designed for the measurement of material tension on continuous processing lines, are used in combination with standard pillow blocks. Block mounting is simple utilizing four fasteners into the bottom surface. force measuring blocks of the UMGZ-Series feature longevity, precision and reliability. The UMGZ-Series is available in two versions, horizontal and vertical, and thus can be specified for use in any mounting orientation and strip wrap configuration. With the superior performance of the UMGZ-Series, accurate tension readings are obtained even with low web wrap angles and high roll weights.

3.2 Functional description

Standard pillow blocks are installed on the force measuring blocks of the UMGZ-Series. This design combines force sensor and bearing seat and allows for easy maintenance or exchange of the blocks, bearings and roll. The UMGZ-Series is available in two measuring versions, horizontal and vertical, and thus can be specified for use in any mounting orientation and material wrap configuration. The UMGZ-Series design, incorporating dual bending beams, eliminates the load-specific influences of torque. The movement of the bending beams is detected by a set of strain gages arranged in a full bridge circuit. The resulting electrical signal, which is proportional to the applied force, is then amplified for use in monitoring or controlling web tension. With the superior performance of the UMGZ-Series, accurate tension readings are obtained even with low web wrap angles and high roll weights.

3.3 System arrangement

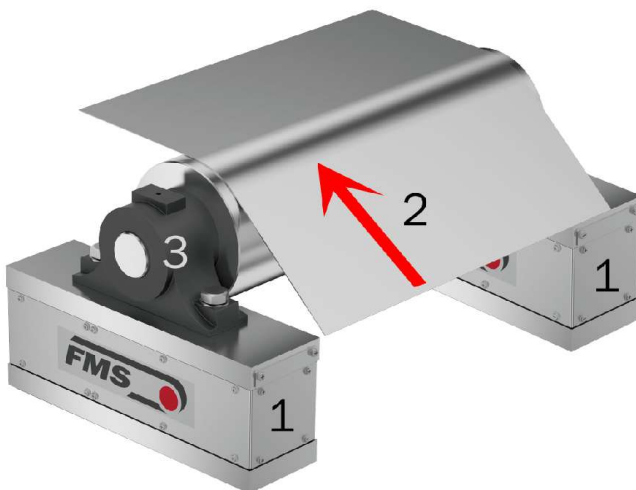
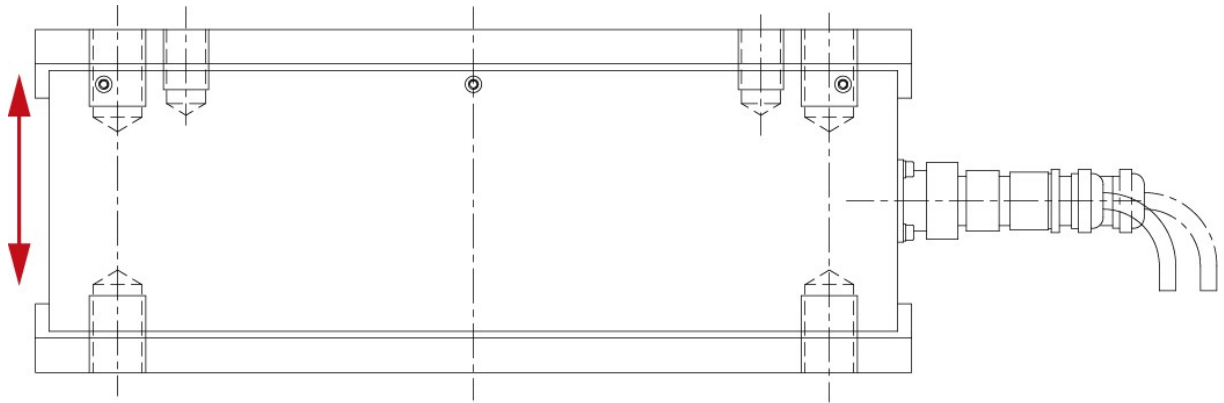

Illustration 1: arrangement of force sensors *smgz_mit_walze_und_blech.tif*

System arrangement	
Position	Description
1	Force sensors (electrical connections are not displayed)

2	Strip with moving direction
3	Left pillow block with shaft and roller

3.3.1 Vertical measuring block



Vertikaler Messblock - kein roter Punkt
vertical measuring block - no red point

Illustration 2: Side view of vertical version with measuring direction
UMGZ_BA_Manual.ai

FMS recommends the use of the vertical version only for compressive loads.

If the forces act with angles deviating from the vertical in the case of version V, only a reduced force can be measured by the force measuring block according to the correction table. This must be taken into account when determining the amplification factor. The angle should not exceed 30°.

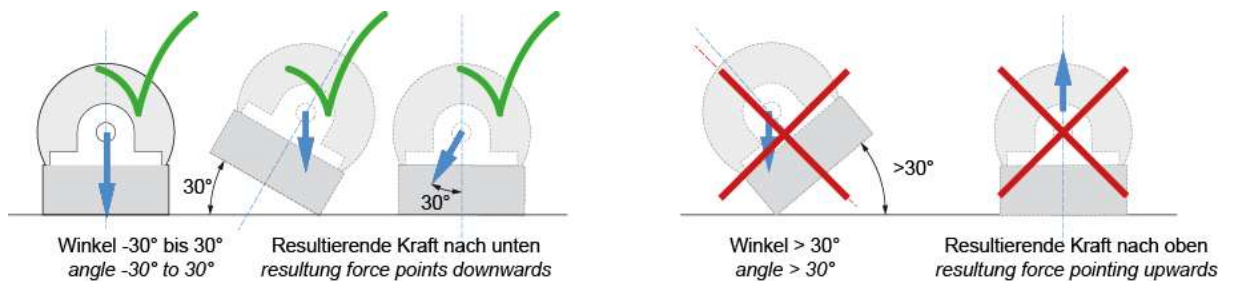

Illustration 3: Angular deviation, tensile stress

UMGZ_BA_Manual.ai

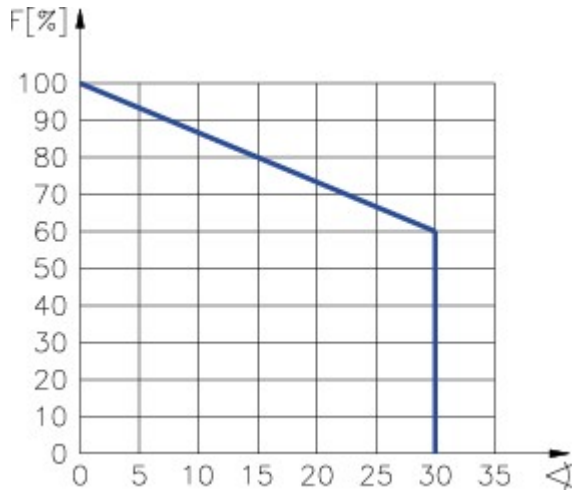
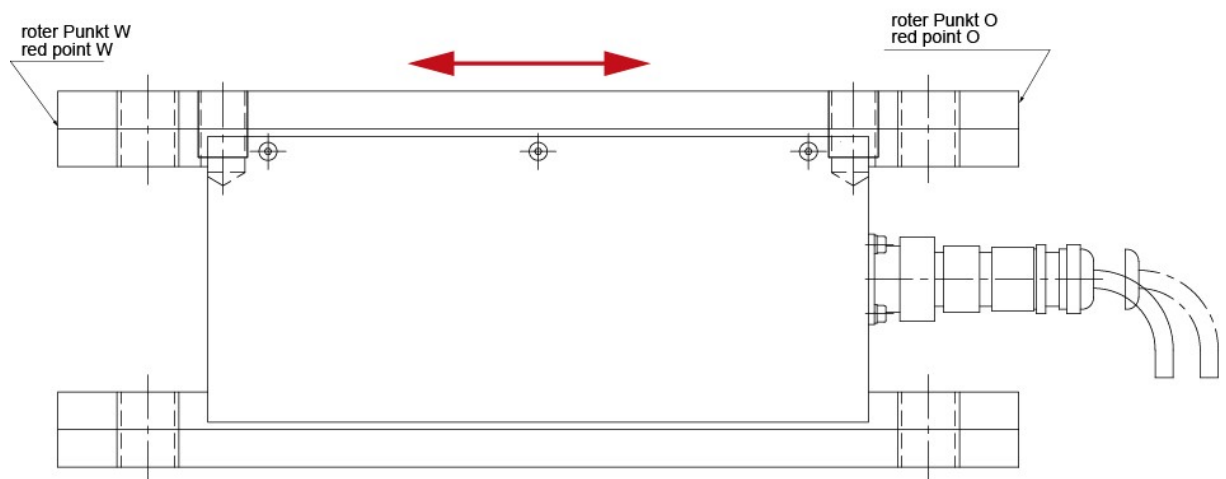

Illustration 4: ange correction table

UMGZ_BA_Manual.ai

3.3.2 Horizontal measuring block



Horizontaler Messblock - Orientierung roter Punkt in Abhängigkeit von elektrischem Anschluss
 horizontal measuring block - red point orientation depending on electrical connection

Illustration 5: Side view of horizontal version with measuring direction

UMGZ_BA_Manual.ai

3.4 Scope of delivery

Included:

force sensor, straight, waterproof connector (female)

Options

H14 right-angle connector in scope of supply, replaces straight connector

H16 temperature range up to 120 °C (248 °F)

H21 electrical connection with PG gland with 5 m (16 ft.) cable, replaces connector

H29 resistant against aggressive media, especially acids (please specify), up to 120 °C (248 °F)

H30 resistant against aggressive media, especially hydrocarbons (please specify) up to 120 °C (248 °F)

H31 for vacuum applications to 1E-7 hPa , 1E-5 Torr, up to 120 °C (248 °F)

H33 temperature range up to 150 °C (302 °F), with pg-gland and 5 m (16 ft.) cable

Accessories

prefabricated cable (specify length) with connector (straight or right-angle)

3.5 Order code

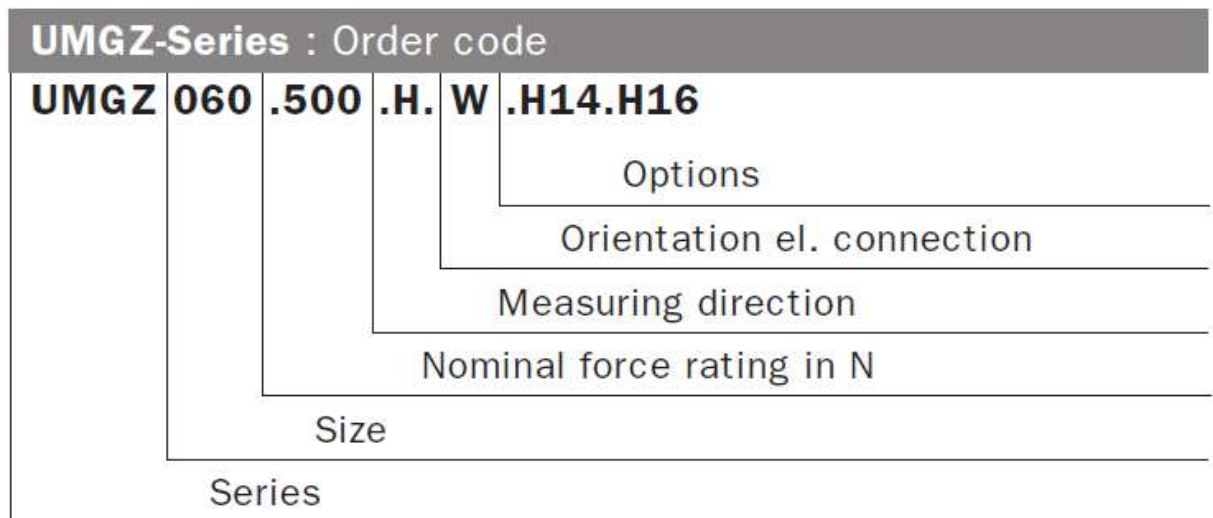

Illustration 6: Ordering code

Datasheet_UMGZ_series.indd

4 Installation

4.1 Installation conditions

Force sensors are defined as “partly completed machinery” according to the Directives 2006/42/EC, article 2. In order to assure a proper functionality of the parts and assure the essential safety requirements of operators working with it, the following conditions for the assembly must be met:



The Force Measuring Rollers may not be stressed over the specification limits neither during assembly nor operation. The unit's overload protection value may not be exceeded.



The mounting points for the Force Measuring Rollers on the machine frame must be properly designed. The bearings need to be appropriately mounted.



For proper installation and operation, follow the electrical wiring diagram and instructions in this manual.

4.2 Preparing the machine frame

Two force sensors are required to equip a measuring roller. For the installation of each block an even surface with the respective bore pattern needs to be prepared on the machine frame.

The contact surfaces for both force sensors must be even and aligned in the same height to ensure proper alignment of the measuring roller.

Vertical measuring blocks:

These version measures forces in vertical direction. Compressive force leads to a positive, tensile force should be avoided. **Vertical measuring blocks do not have a Red Point.**

Horizontal measuring blocks:

The Red Point indicated the direction where a applied force will generate a positive signal.

The design will allow the easy installation of a pillow block. With a customized adapter plate the force sensor will be able to hold any other type of roller supports.

The roller support needs to be realized with fixed and a floating bearing side.

4.3 Electrical connections

Connection between the force sensors and the amplifier is realized by means of a 4-pole cable with a cross-section of 0.25mm². The cable must be installed separate from power lines.

The shield needs to be connected to the amplifier only.

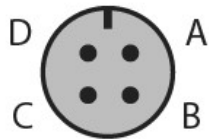
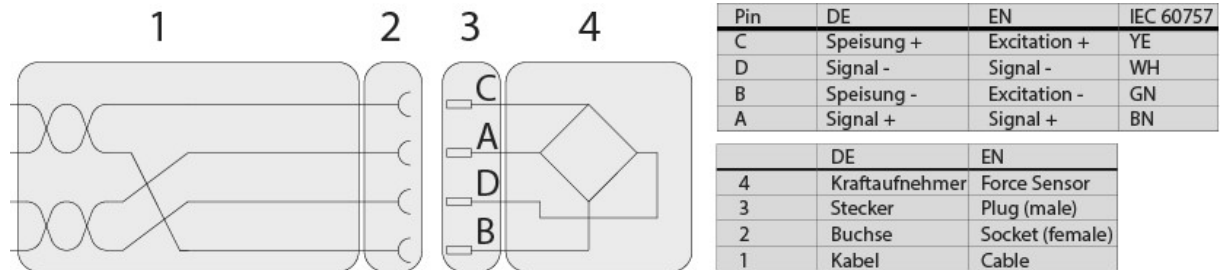

Polbild, Ansicht Stift-/ Steckerseite
 Pin assignment, top view male connector

Farbangaben (IEC60757) und Codierung gelten nur für FMS Komponenten!
 Color scheme (IEC60757) and pin codes are valid for FMS components, only!

Illustration 7: electrical connection

Pin_Assignment_Sensorkabel_Farben_Stecker.ai

5 Technical data

Sensitivity	1.8 mV/V
Tolerance of the sensitivity	<± 0.2 %
Accuracy class	±0.5 % of nominal load
Temperature coefficient	±0.1 %/10K
Temperature range	-10 bis +55 °C (14 to 130 F)
Input resistance	350 Ω
Excitation voltage	1 to 7 VDC
Overload protection	10-times nominal load
Material sensor body	Stainless steel
Protection rating	IP42
Electrical connection	Male flange connector, Amphenol 4-pole
Repeatability error	0.05%
Measuring range	30:1

Table 1: Technical data

6 Dimensions in mm (in.)

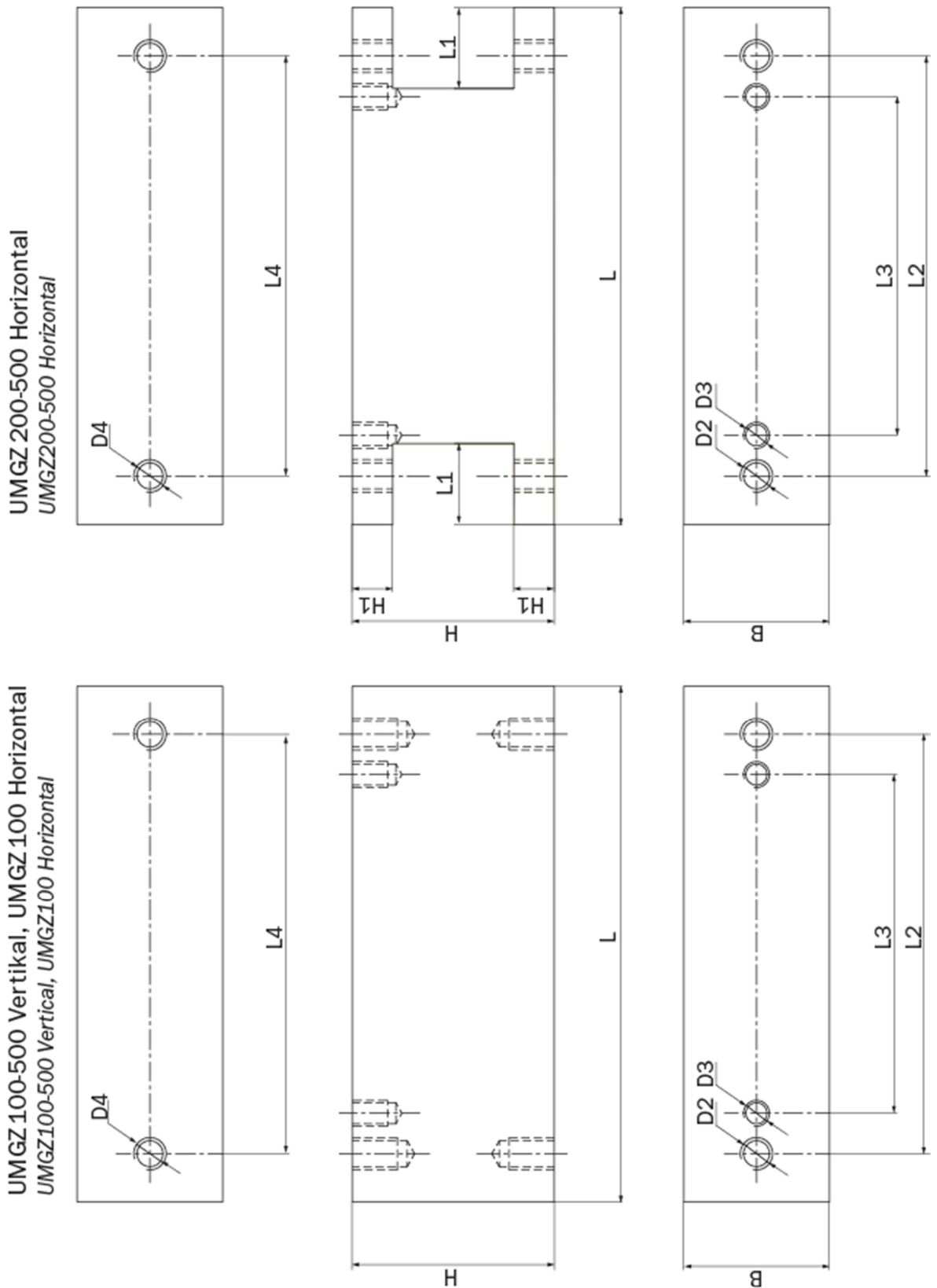

Illustration 8: Dimensions

UMGZ_BA_Manual.ai

UMGZ-Series : Nominal forces, Shaft diameter, Deflection						
Size Type	Nominal force kN (lbf.)		Shaft diameter d ø mm (in.)		Deflection mm (in.)	
UMGZ060	0.25, 0.5, 1, 2	(56, 112, 224, 449)	12 – 25	(0.47 – 0.98)	0,2	(0.0079)
UMGZ080	0.5, 1, 2, 5	(112, 224, 449, 1124)	30 – 40	(1.18 – 1.57)	0,2	(0.0079)
UMGZ100	0.5, 1, 2, 5, 10, 20	(112, 224, 449, 1124, 2248, 4496)	20 – 50	(0.49 – 1.97)	0,5	(0.0197)
UMGZ200	2, 5, 10, 20, 30, 40	(449, 1124, 2248, 4496, 6744, 8992)	40 – 85	(1.57 – 3.35)	0,5	(0.0197)
UMGZ300	5, 10, 20, 50	(1124, 2248, 4496, 11240)	75 – 100	(2.95 – 3.94)	0,5	(0.0197)
UMGZ435	10, 20, 50, 100	(2248, 4496, 11240, 22480)	85 – 120	(3.35 – 4.72)	0,5	(0.0197)
UMGZ439	10, 20, 50, 100	(2248, 4496, 11240, 22480)	100 – 110	(3.94 – 4.33)	0,5	(0.0197)
UMGZ500	10, 20, 50, 100	(2248, 4496, 11240, 22480)	110 – 160	(4.33 – 6.30)	0,5	(0.0197)

UMGZ-Series : Dimensions, Installation bores, Weight							
Size Type	Dimensions mm (in.)			Installation bores top		Installation bores bottom L4 x D4	Weight max. kg (lbs.)
	L	B	H	L2 x D2	L3 x D3		
UMGZ060	140 (5.51)	60 (2.36)	90 (3.54)	100 (3.94) x M10		100 (3.94) x M10	5 (11.02)
UMGZ080	190 (7.48)	60 (2.36)	90 (3.54)	131 (5.16) x M12		131 (5.16) x M12	6.5 (14.33)
UMGZ100	230 (9.06)	90 (3.54)	125 (4.92)	170 (6.69) x M12	130 (5.12) x M12	170 (6.69) x M12	15.5 (34.17)
UMGZ200	320 (12.60)	90 (3.54)	125 (4.92)	260 (10.24) x M20	210 (8.27) x M16	260 (10.24) x M20	21 (46.30)
UMGZ300	380 (14.96)	110 (4.33)	125 (4.92)	320 (12.60) x M24		320 (12.60) x M24	31 (68.34)
UMGZ435	450 (17.72)	130 (5.12)	125 (4.92)	350 (13.78) x M24		390 (15.35) x M24	35 (77.16)
UMGZ439	450 (17.72)	130 (5.12)	125 (4.92)	390 (15.35) x M24		390 (15.35) x M24	35 (77.16)
UMGZ500	560 (22.05)	170 (6.69)	150 (5.91)	470 (15.50) x M30		470 (15.50) x M30	75 (165.35)

Table 2: Dimension overview

Datenblatt_UMGZ_series.indd



FMS Force Measuring Systems AG
 Aspstrasse 6
 8154 Oberglatt (Switzerland)
 Tel. 0041 1 852 80 80
 Fax 0041 1 850 60 06
 info@fms-technology.com
 www.fms-technology.com

FMS USA, Inc.
 2155 Stonington Avenue
 Suite 119
 Hoffman Estates., IL 60169
 (USA)
 Tel. +1 847 519 4400
 Fax +1 847 519 4401
 fmsusa@fms-technology.com

FMS (UK)
 Aspstrasse 6
 8154 Oberglatt (Switzerland)
 Tel. +44 (0)1767 221 303
 fmsuk@fms-technology.com

FMS (Italy)
 Aspstrasse 6
 8154 Oberglatt (Switzerland)
 Tel. +39 02 39487035
 fmsit@fms-technology.com