



# Operating Manual BKS309

## Digital Web Guide Controller

Document Version 2.60 07/2019 NS

Firmware Version V3.00



**Diese Bedienungsanleitung ist auch in Deutsch erhältlich.  
Bitte kontaktieren Sie Ihren nächstgelegenen FMS Vertreter.**

© by FMS Force Measuring Systems AG, CH-8154 Oberglatt – Alle Rechte vorbehalten.

# 1 Table of Contents

<b>1</b>	<b>TABLE OF CONTENTS .....</b>	<b>2</b>
<b>2</b>	<b>SAFETY INSTRUCTIONS.....</b>	<b>3</b>
2.1	Presentation of safety information .....	3
2.1.1	Danger that could result in minor or moderate injuries.....	3
2.1.2	Note regarding proper function .....	3
2.2	General safety information .....	3
<b>3</b>	<b>PRODUCT INFORMATION.....</b>	<b>4</b>
3.1	Functional Description.....	4
3.2	Web guide controller .....	4
3.3	Order code and variations of the web guide controller BKS309 .....	5
3.4	Steering frames, steering rollers or actuators .....	6
3.5	Material sensors.....	6
<b>4</b>	<b>QUICK INSTALLATION GUIDE .....</b>	<b>7</b>
4.1	Configuration.....	7
<b>5</b>	<b>INSTALLATION AND WIRING .....</b>	<b>8</b>
5.1	Installation of a steering frame of the FMS-webMASTER series.....	8
5.1.1	Installation of the material sensor .....	8
5.1.2	Alignment of the material sensors .....	9
<b>6</b>	<b>ELECTRICAL CONNECTION.....</b>	<b>11</b>
6.1	Web guide controller BKS309.....	11
6.2	Material sensors.....	12
6.3	Steering frame BKS020.EE and BKS015.EE with external web guide controller BKS309 .....	12
6.4	Steering frame FMS-webMASTER BKS030 or actuators FMS-winderGLIDE BKS.D.3 or BKS.D.4 13	13
6.5	Actuator FMS-winderGLIDE BKS.D.7.....	13
<b>7</b>	<b>OPERATION AND CONFIGURATION .....</b>	<b>15</b>
7.1	Automatic mode .....	17
7.2	Manual mode .....	17
7.3	Approaching and saving dedicated positions.....	18
<b>8</b>	<b>CONFIGURATION VIA OPERATING PANEL.....</b>	<b>19</b>
8.1	Operating parameters .....	19
8.2	List of operating parameters .....	19
8.3	Description of operating parameters .....	22
8.4	System parameters .....	30
8.5	List of System parameters .....	30
8.6	Description of system parameters .....	31
8.7	Reset to factory settings.....	34
<b>9</b>	<b>CONFIGURATION VIA WEB BROWSER.....</b>	<b>35</b>
9.1	Peer-to-Peer connection .....	39
<b>10</b>	<b>DIMENSIONS .....</b>	<b>42</b>
<b>11</b>	<b>TECHNICAL DATA .....</b>	<b>45</b>
<b>12</b>	<b>TROUBLE SHOOTING .....</b>	<b>46</b>

## 2 Safety instructions

All safety related regulations, local codes and instructions that appear in the manual or on equipment must be observed to ensure personal safety and to prevent damage to the equipment connected to it. If equipment is used in a manner not specified by the manufacturer, the protection provided by the equipment may be impaired.

Do not stress the equipment over the specification limits neither during assembly nor operation. To do so can be potentially harmful to persons or equipment in the event of a fault to the equipment.

### 2.1 Presentation of safety information

The following safety symbols appear in this manual.

#### 2.1.1 Danger that could result in minor or moderate injuries



Danger, warning, caution

Failure to follow wiring instructions in this manual may result in equipment damage or personal injury.

#### 2.1.2 Note regarding proper function



Note

Note regarding proper operation  
Simplification of operation  
Ensuring function

### 2.2 General safety information



The Force Measuring Rollers may not be stressed over the specification limits neither during assembly nor operation. The unit's overload protection value may not be exceeded.



The attachment points for the Force Measuring Rollers on the machine frame must be properly designed. The bearings need to be appropriately mounted.



For proper installation and operation, follow the electrical wiring diagram and instructions in this manual.

### 3 Product information

#### 3.1 Functional Description

The sensors measure the position of the web edge and send this information as an analogue signal to the electronic control unit. In our case a BKS309 web guide controller.

The control compares the position feedback signal with the reference. If the difference of these two values is higher than the stored dead band value, the steering frame will be adjusted.

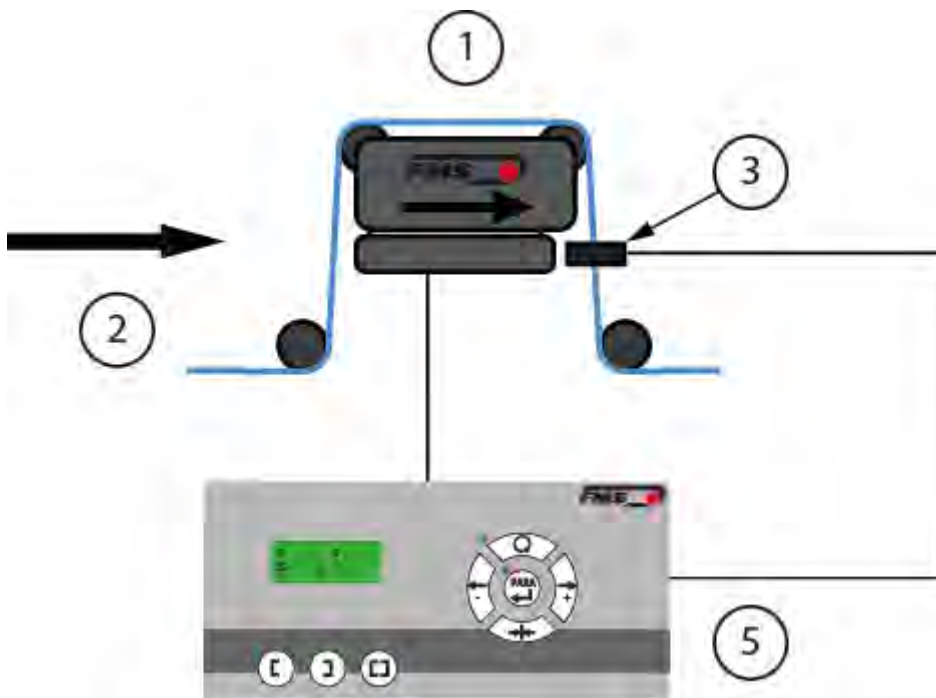

Figure 1: typical arrangement

BKS309\_BA\_manual.ai

Description	
Position	Description
1	Steering frame, steering roller, actuator
2	Web, entry side
3	Material sensor(s)
5	Web guide controller

Table 1: designation web guide controller

#### 3.2 Web guide controller

The micro-processor based electronic control unit handles all calculations and communications. Three buttons and a five-key panel serves as the man-machine interface. Parameter setting can be performed via the operating panel or via a web browser. All parameters are stored in a none-volatile memory.

### 3.3 Order code and variations of the web guide controller BKS309

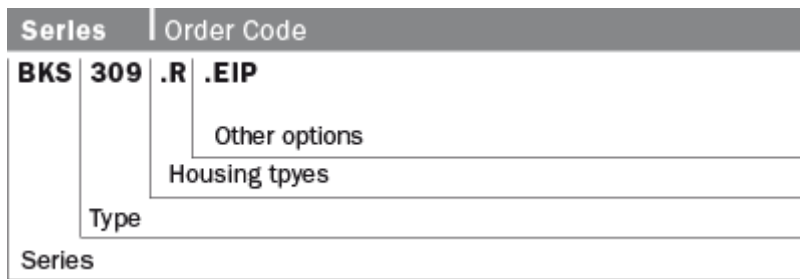

Figure 2: order code

BKS309\_BA\_manual.ai

Description	
<b>Housing types</b>	<b>description</b>
BKS309.W	Wall mount, for field installation
BKS309.R	DIN-rail mount, for cabinet installation
BKS309.S	Panel mount, integrated in front panel
<b>Other Options</b>	<b>description</b>
.EIP	EtherNet/IP interface (see operating manual BKS309.EIP)
.M	To control one or two motorized traverses (see operating manual BKS309.W.M)
.MS	To control Chase-and-Follow applications (see operating manual BKS309.W.MS)
.DC	To control actuators with DC motor, FMS-winderGLIDE BKS.D.7
.ACV	Power supply 110 bis 240VAC

Table 2: overview variations

Variations				
	BKS309.W	BKS309.R	BKS309.S	For web guide solutions
Standard	X	X	X	BKS015.EE, BKS020, BKS030, BKS042, BKS.D.3, BKS.D.4
.ACV	X	X	X	BKS020, BKS030, BKS042, BKS.D.3, BKS.D.4
.EIP	X	X	X	BKS020, BKS030, BKS042, BKS.D.3, BKS.D.4
.M	X			BKS020, BKS030, BKS042, BKS.D.3, BKS.D.4
.MS	X	X		BKS020, BKS030, BKS042, BKS.D.3, BKS.D.4
.DC	X	X		BKS020, BKS030, BKS042, BKS.D.3, BKS.D.4, BKS.D.7

Table 3: BKS309 variations and options

### 3.4 Steering frames, steering rollers or actuators

Steering frames of the FMS-webMASTER series consist of a fixed lower and a moveable upper frame that supports the rollers. The upper frame is activated by a motor. The rollers are manufactured and balanced according to customer specification. End positions are controlled. A location rail for easy sensor attachment is integrated to the steering frames.

The web guide controller BKS309 can be used for rewind und unwind stations in combination with actuators of the FMS-winderGLIDE series.

The combination with steering rollers of the FMS-webDIRECTOR series is also possible.

### 3.5 Material sensors

Optical sensors, ultrasonic sensors and a digital line sensor are available from FMS. Adjustment is done automatically.

These sensors provide a signal of 0 to 10VDC. With them, edge, center and line guiding applications can be covered.



#### Retrofit a digital line sensor

If you retrofit a sensor to an existing controller you have to restart the controller after the installation of the sensor. This will allow the controller to detect sensor correctly.

## 4 Quick Installation Guide

The set-up of the BKS309 web guide controller and corresponding web guide is limited to only mounting the devices on the machine frame, wiring and powering up system.

### 4.1 Configuration

- Read the operating manual of your web guide or actuator system.
- Check your system requirements such as:
  - o Desired guiding form (edge, centre or line guiding)
  - o Unit system (metric, imperial)
  - o Relay or digital input requirements of your set-up
- Draw the wiring diagram for your configuration
- Mount and adjust your material sensor(s) to the steering frame (see p. 8ff)
- Mount the steering frame or actuator to the machine
- Wire the sensor(s) to the electronic unit (see p. 12ff)
- Wire the steering frame to the electronic unit (see p. 11ff)
- Mount the electronic unit on a place where it can be easily reached by the operator
- Install 24VDC (18 to 30VDC)
- If required, determine special parameters (see p. 19ff)

## 5 Installation and wiring

### 5.1 Installation of a steering frame of the FMS-webMASTER series

The mounting orientation of the steering frame (indicated by an arrow), must correspond with the direction of the moving web. The lower frame is mounted with four M8 screws to the machine frame. The machine must be prepared to accept the M8 mounting screws.

The steering frame must be grounded. Connect the ground wire to the machine ground.

#### 5.1.1 Installation of the material sensor

The material sensors will be mounted with brackets to the rail of the steering frame or to the sensor arrangement of the unwind/rewind stand (see installation instruction of the material sensors).

The installation side "left" and "right" of the material sensor is defined by the direction of the moving web.

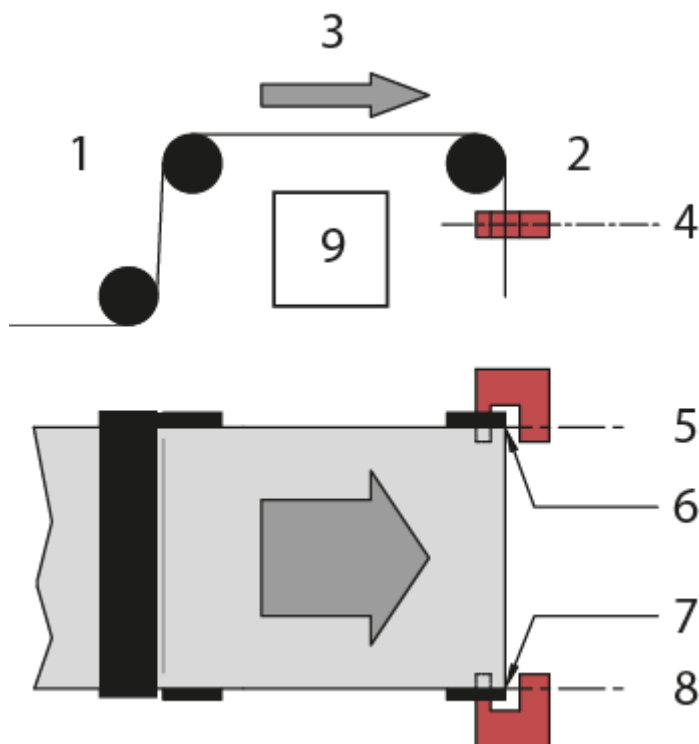

Figure 3: direction of the moving web

BKS309\_BA\_manual.ai



Description	
Position	Description
1	Web entry side
2	Web exit side
3	Direction of the moving web
4	Material sensor, sensor axis
5	Material sensor, sensor axis left
6	Web edge left
7	Web edge right
8	Material sensor, sensor axis right
9	Integrated web guide controller BKS309.S (optional)

Table 4: description



Material sensors have to installed on the web exit side  
 Installation on the entry side of the web will not work of proper functionality.



Material sensors as close to roller as possible  
 For optimum control results, the material sensors have to be placed next to the exit roller of the steering frame.

### 5.1.2 Alignment of the material sensors

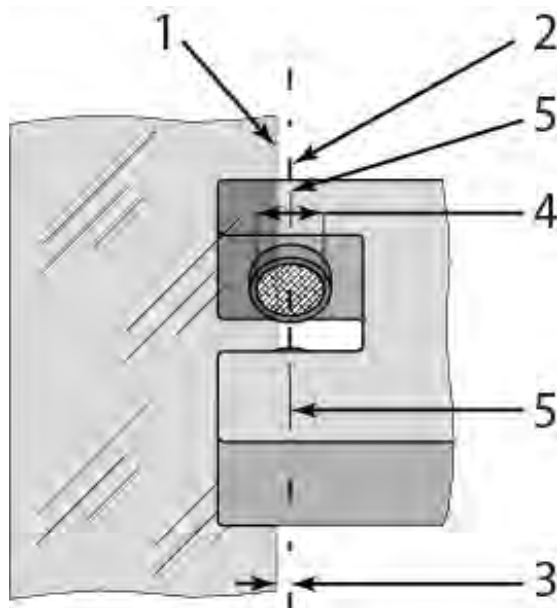

Figure 4: alignment of the material sensors

BKS309\_BA\_manual.ai

<b>Description</b>	
<b>Position</b>	<b>Description</b>
<b>1</b>	<b>Web edge</b>
<b>2</b>	<b>Sensor axis</b>
<b>3</b>	<b>Deviation of web edge from sensor axis</b>
<b>4</b>	<b>Detection range of material sensor</b>
<b>5</b>	<b>Center mark of the detection range</b>

*Figure 5: Material sensors*

- Loosen the clamp
- Align sensor axis to the web edge
- Slide the sensor in the new position.
- The sensor will be positioned properly if the web edge goes through the sensor axis
- Tighten the clamp

# 6 Electrical connection



## Ground connection

Insufficient ground connection may cause electric shock to persons, malfunction of the total system or damage of the control unit! It is vital to ensure that there is a proper and secure earth connection.

## 6.1 Web guide controller BKS309

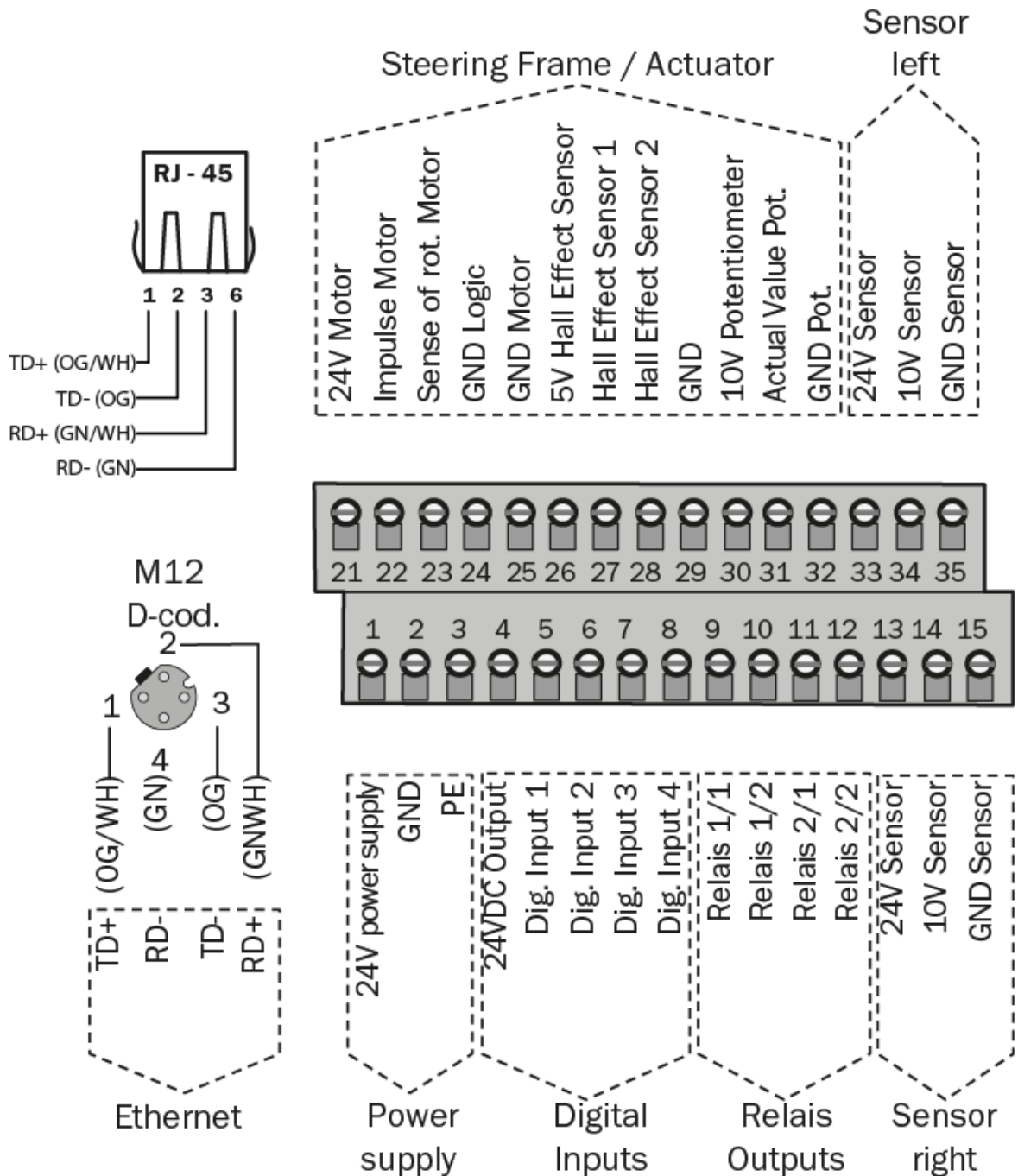

Figure 6: electrical connection

## 6.2 Material sensors

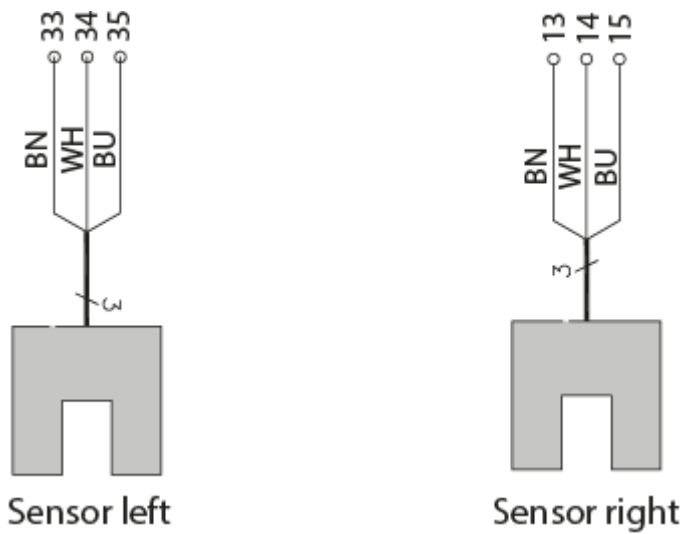

Figure 7: electrical connection material sensors

BKS309\_BA\_manual.ai

## 6.3 Steering frame BKS020.EE and BKS015.EE with external web guide controller BKS309

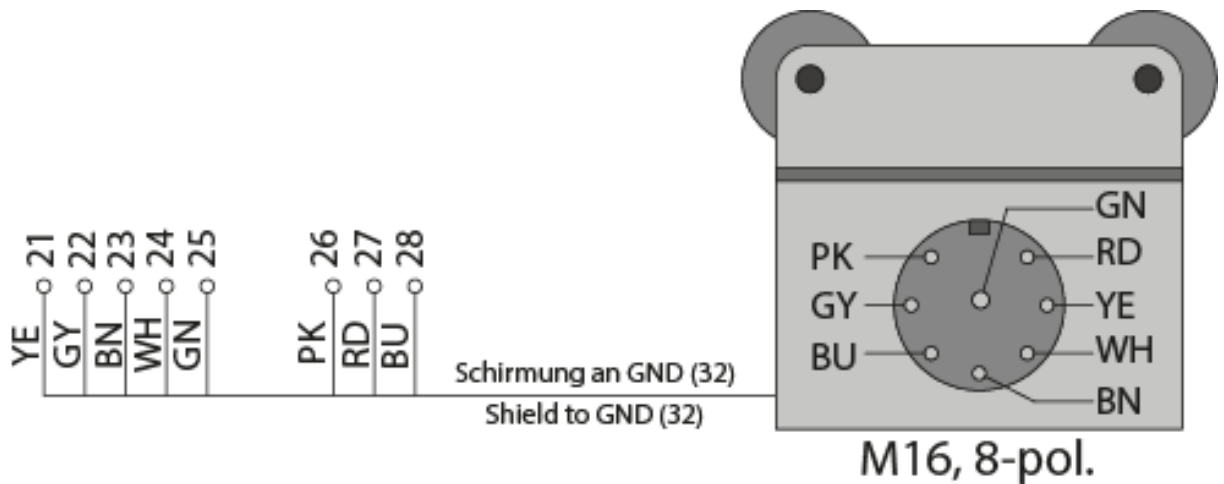

Figure 8: electrical connection BKS020.EE and BKS015.EE

BKS309\_BA\_manual.ai

## 6.4 Steering frame FMS-webMASTER BKS030 or actuators FMS-winderGLIDE BKS.D.3 or BKS.D.4

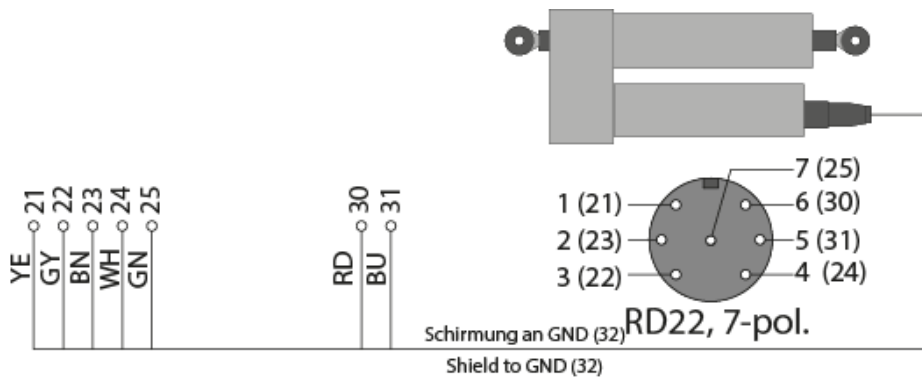

Figure 9: electrical connection BKS030, BKS.D.3, BKS.D.4 BKS309\_BA\_manual.ai

## 6.5 Actuator FMS-winderGLIDE BKS.D.7



Only in combination with BKS309.R.DC or BKS309.W.DC

The use of any other web guide controller will lead to damage or destruction of the components.

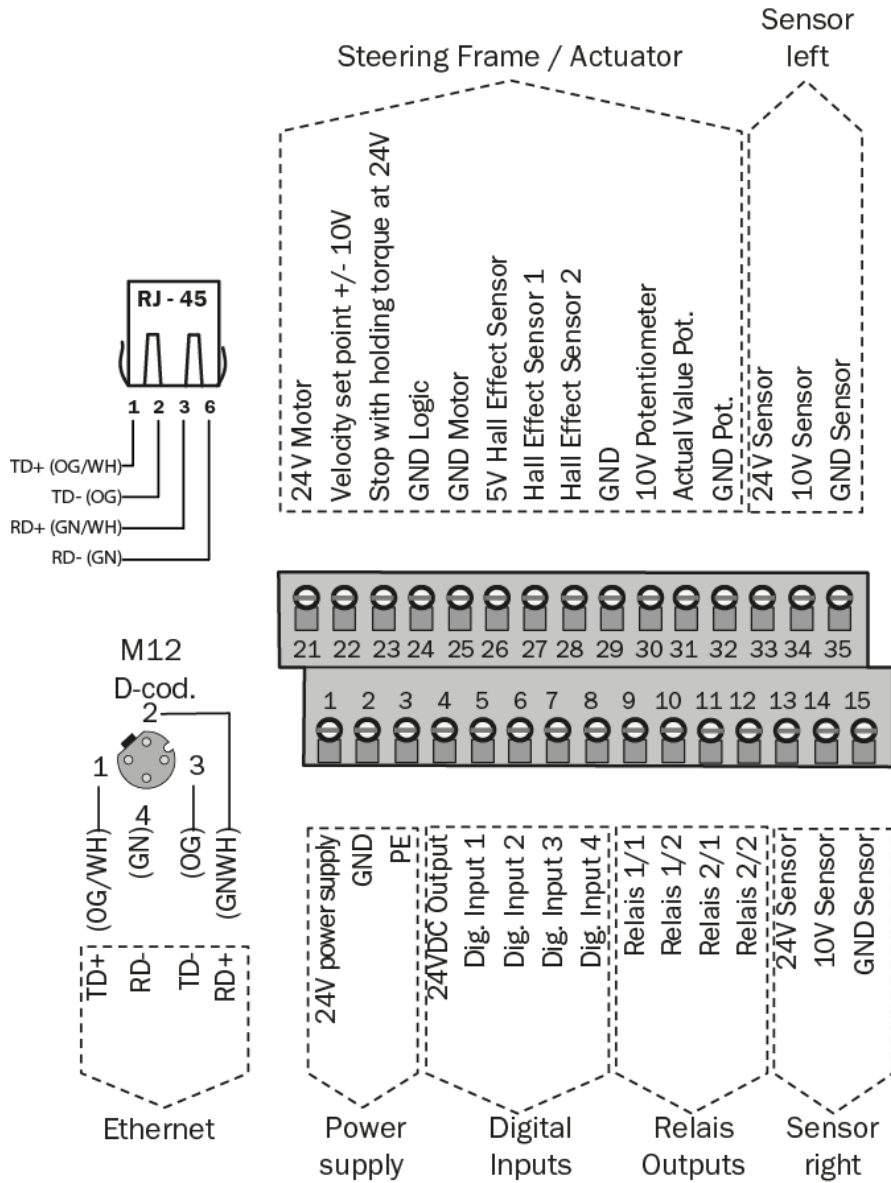

Figure 10: electrical connection BKS309.DC (.R and .W)

BKS309\_BA\_manual.ai

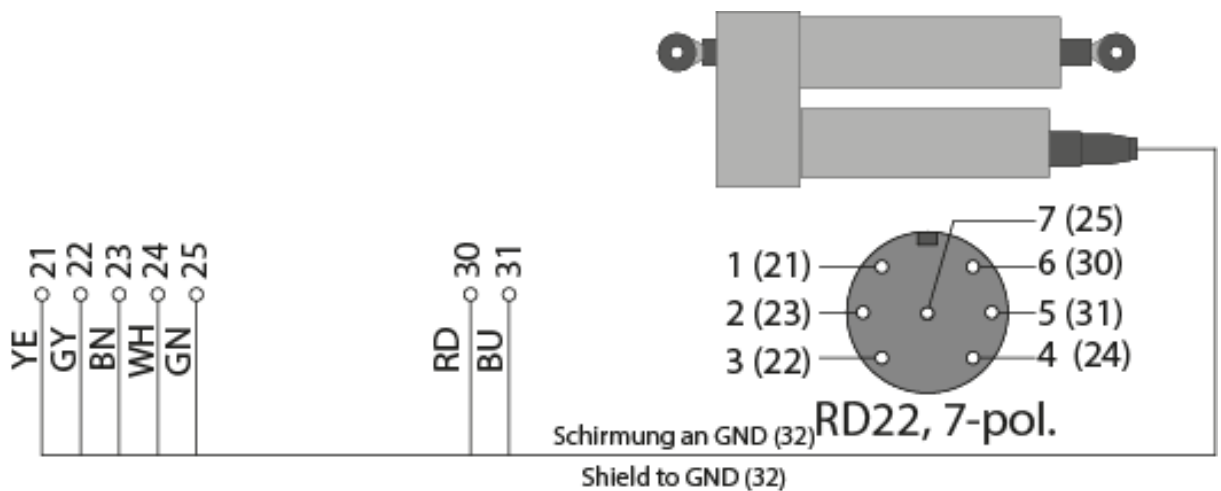

Figure 11: electrical connection BKS.D.7

BKS309\_BA\_manual.ai

## 7 Operation and configuration

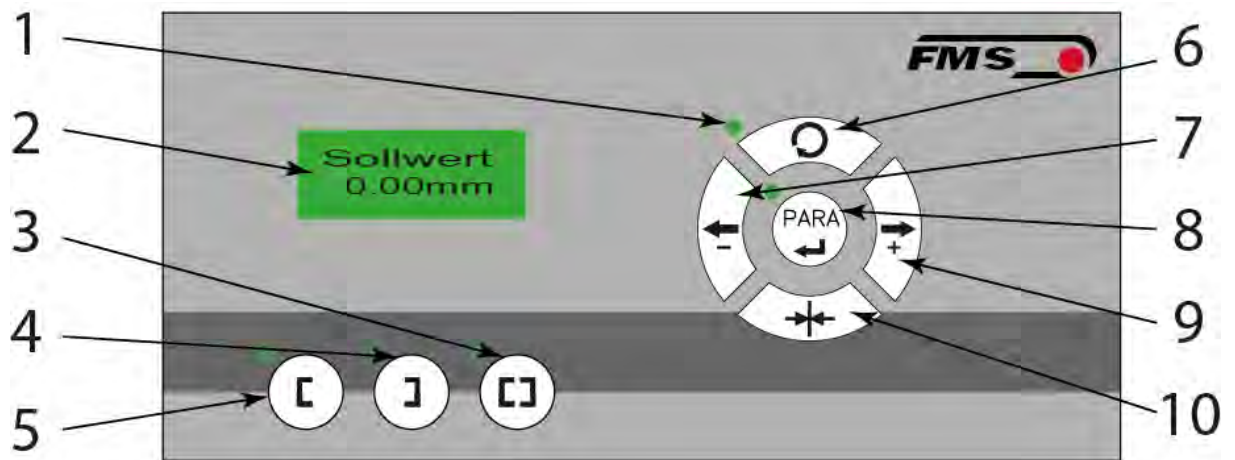

Figure 12: Operating panel

BKS309\_BA\_manual.ai

Description	
Position	Description
1	LED operating status, on if in automatic mode
2	LCD
3	Center guiding
4	Edge guiding right
5	Edge guiding left
6	Toggle from automatic to manual mode
7	Configuration menu
8	Manually drive right, increase value
9	Manually drive left, decrease value
10	Move to center position

Table 5: operating panel

Description	
<i>button</i>	<i>Function</i>
	The sensor is mounted on the left side of the frame and controls the material on the left edge or on the line, if a line sensor is used. One sensor is necessary. The LED indicates the left edge guiding mode.
	The sensor is mounted on the right side of the frame and controls the material on right edge or on the line, if a line sensor is used. One sensor is necessary. The LED indicates the right edge guiding mode.
	Two sensors are mounted on both sides of the frame. The frame is controlled in a way that the material position is kept centered with regard to both sensors position. The LED indicates the center guiding mode.
	To enter the operating parameters menu, hold the key for longer than 3 sec. The LED will light and the first parameter will appear on the LCD display indicating that you entered the mode. A second press on the PARA key will cause the parameter to flash. Now it can be changed
	Automatic, Manual. With this key you can toggle between automatic and manual mode. The LED indicates the automatic mode.
	Drive to center position. The frame moves to the center Position. Function is only available in manual mode.
	<p><b>In manual mode</b> the frame will move to the left in 0.1mm steps by pressing the button once. By pressing the button longer than 1 sec. it will continuously move the frame to the left.</p> <p><b>In automatic mode</b> the frame set-point will be adjusted to the left in 0.1 mm steps by pressing the button once. Pressing the button longer than 1 sec. it will continuously move the set-point of the frame to the left.</p> <p><b>In configuration mode</b> this function will decrease the selected parameter value.</p>
	<p><b>In manual mode</b> the frame will move to the right in 0.1mm steps by pressing the button once. By pressing the button longer than 1 sec. it will continuously move the frame to the right.</p> <p><b>In automatic mode</b> the frame set-point will be adjusted to the right in 0.1 mm steps by pressing the button once. Pressing the button longer than 1 sec. it will continuously move the set-point of the frame to the right.</p> <p><b>In configuration mode</b> this function will increase the selected parameter value.</p>

Table 6: buttons and functions





### Flashing LED with connected line sensor

If a digital line sensor is used, it may happen that the web guide controller blocks the steering frame. This protective function is activated when the line is interrupted and impossible to detect anymore. The LED will start flashing to indicate the bad line quality.

## 7.1 Automatic mode

Start automatic mode with  key or digital input. Reference position is taken from the middle of the sensor detection band. Using center guide, reference position is in the middle between the two sensor axis. The controller starts to guide the web to reference position and to hold this guide point.

The reference position can be adjusted during automatic operation by using the keys

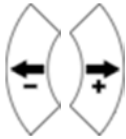

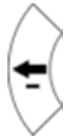
or the digital inputs (step width 0.1 mm). Using the  key, the web moves in

the sensor; using the  key, the web moves outwards.

Using center guide, this description refers to the moving direction on the right sensor.

Terminate the automatic mode by using the  key again.



### Material left sensor detection range

The control will stop if the material leaves the detection range of the material sensor.





### Static web

Automatic control can only be provided on a moving web.

## 7.2 Manual mode

Center position 

- The steering frame will return to center position.







Frame position  and 

- The steering frame can be adjusted in 0.1mm steps.

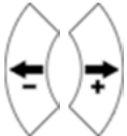
- If key is held, steering frame is moving continuously.
- These functions can also be carried out via the digital inputs

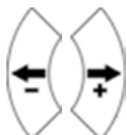
### 7.3 Approaching and saving dedicated positions

There are two possibilities to alter the values of the Home Position, Middle Position and Maximum Positions of the actuator. Either you modify the parameters [Home Pos], [Mid Pos] and [Max Pos] in the menu of the operating parameters or you drive manually to the desired position and save it.



- Enable the change of the travel limits by pressing the two keys  at the same time. The LED above the  key will be on.
- Travel with the actuator to the desired position with the keys 
- The display will show the actual position with an accuracy of 0.1mm
- Press the  key. The LED above the key starts flashing and expects the definition of the setting.
- The definition is done with
  - o  for the Home Position
  - o  for the Maximal Position and
  - o  for the Middle Position
- On the displayed following comments will report completion.
  - o Display first line [Save Pos]
  - o Display second line [Done] or [Invalid]
- In the case of [Invalid] the display flashes.
- Possible cause: the position couldn't be found e.g. because the "home" or "maximum" position was set over the middle position.



## 8 Configuration via operating panel

### 8.1 Operating parameters

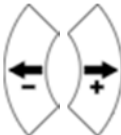
To access the menu for the operating parameters the web guide controller must be in the manual mode.

Press the  key for longer than 3 sec. The LED will be on and the first parameter will be displayed.

With the   buttons the parameter list can be scrolled up and down. By pressing the  button again you will enter the parameter setting mode. The selected parameter

on the display flashes indicating that it can be modified with the buttons  

To save the changes, press .

### 8.2 List of operating parameters

Description						
Parameter	LCD	Unit	Min	Max	Selection	Factory
Adjust Reference Position	Ref Pos	mm	-5.00	+5.00	-	0.00
Set Reference Mode	Ref Mode	-	-	-	Manual Auto	Manual
Save the Reference Position	SaveRef	-	-	-	No Yes	No
Dead band	DeadBand	mm	0.0	2.0	-	0.1

Description						
Parameter	LCD	Unit	Min	Max	Selection	Factory
Relay 1 or Relay 2 setting	Relay 1 Relay 2	-	-	-	MidSenso MatFound Auto&Mat Aut&Miss Auto Centre Disabled	R1= MidSenso  R2= MatFound
Digital Input 1, 2, 3 or 4 Modes	Input 1 Input 2 Input 3 Input 4	-	-	-	Edge→Aut Lv→Auto Centre - Ref/← +Ref/→ Lock ResetRef Disabled	I1= Edge→Aut I2=Center I3= -Ref/← I4= +Ref/→
DLS Sensor	DLS	-	-	-	none left right	none
Password	Password	-	-	-	No Yes	No
Language	Language	-	-	-	English German	English
LCD-Contrast	Contrast	%	1	100	-	65
Unit System	Unit Sys	-	-	-	Metric Imperial	Metric
Gain Setting	Gain	-	0.02	2.00	-	0.2
Adjust Correction Speed	AdjSpeed	%	1	100	-	100

<b>Description</b>						
<b>Parameter</b>	<b>LCD</b>	<b>Unit</b>	<b>Min</b>	<b>Max</b>	<b>Selection</b>	<b>Factory</b>
<b>Power Modes</b>	<b>Power ON</b>	-	-	-	Manual Auto Last Set	Manual
<b>Behavior when leaving Automatic Mode</b>	<b>Auto→Man n</b>	-	-	-	Manual Centre	Manual
<b>Home Position <sup>3)</sup></b>	<b>Home Pos</b>	mm	0.0	300.0	-	0.0
<b>Middle Position<sup>3)</sup></b>	<b>Mid Pos</b>	mm	0.0	300.0	-	62.5 <sup>4)</sup>
<b>Maximal Position<sup>3)</sup></b>	<b>Max Pos</b>	mm	0.0	300.0	-	125.0 <sup>4)</sup>
<b>Actuator</b>	<b>Actuator</b>	-	-	-	Left Right	Left
<b>IP Address</b>	<b>IP Addr</b>	-	0	125	-	192.168.0.09 0
<b>Subnet</b>	<b>Subnet</b>	-	0	255	-	255.255.255. 0
<b>Factory Settings <sup>5)</sup></b>	<b>Default</b>	-	-	-	Not set Yes	Not Set

**Table 7: operating parameters**

## 8.3 Description of operating parameters

### Adjust Reference Position [Ref Pos]

<b>Purpose:</b>	The reference position can be adjusted using this parameter.		
<b>Range:</b>	-5.00 to	+5.00	<b>Default:</b> 0.00
<b>Increment:</b>	0.01		<b>Unit:</b> [mm]

### Set Reference Mode [Ref Mode]

**Purpose:** This parameter determinates how the reference position is defined. This can either be the position that is defined with parameter [Ref Pos] or the actual material position within the sensor when the controller is switched to automatic operation.

**Two settings are possible:**

**Setting:**

**Purpose:** If [Manual] is chosen, the Reference Position is taken from the parameter [RefPos].

**Setting:**

**Purpose:** If [Auto] behavior is chosen, the Reference Position is determinate by taking the actual material position within the sensor when the controller is switched to automatic operation.

**Note:** The two parameters [RefMode] and [SafeRef] are conditionally dependent on each other. If you require one of both functions, either set [RefMode] to [Auto] or [SafeRef] to [Yes] .  
Do not activate both functions simultaneously!

### Save the Reference Position [SaveRef]

**Purpose:** The parameter saves the last Reference Position change. It sets after re-booting the Reference Position to the last used value or to 0 (zero).

**Two settings are possible:**

**Setting:**

**Purpose:** If [No] behaviour is chosen, the Reference Position is set to 0 after rebooting (default setting).

**Setting:**

**Purpose:** If [Yes] behavior is chosen, after rebooting the Reference Position is set to the last used value.

**Note:** The two parameters [RefMode] and [SafeRef] are conditionally dependent on each other. If you require one of both functions, either set [RefMode] to [Auto] or [SafeRef] to [Yes] .  
Do not activate both functions simultaneously!

**Dead band [DeadBand]**

**Purpose:** This parameter defines the dead band tolerance. Dead band is a free programmable range, in which the web may move freely without the steering readjusting the frame. Keep in mind that: A [DeadBand] of e.g. 0.3mm results in a tolerance band of  $\pm 0.3$ mm.  
If the deviation is higher than the tolerance, the web will be readjusted into the range of the dead band.

**Range:** 0.0 to 2.0      **Default:** 0.1  
**Increment:** 0.1      **Unit:** [mm]

**Relay 1 or Relay 2 setting [Relay 1 or 2] (two Parameters one for each relay)**

**Purpose:** This parameter determines the relay behaviour.  
The user can choose between seven settings.

**Setting:** **Middle Position [MidSenso]**

**Purpose:** If [MidSenso] is chosen then the relay goes on when the material edge is at the sensor's middle position.  
(Default setting for Relay 1)

**Setting:** **Material Found [MatFound]**

**Purpose:** If [MatFound] is chosen then the relay goes on when the material edge is detected. (Default setting for Relay 2)

**Setting:** **Automatic Mode and Material Found [Auto&Mat]**

**Purpose:** If [Auto&Mat] is chosen then the relay goes on when the material edge is detected and the controller is in Automatic Operation.

**Setting:** **Automatic Mode and Material Missing [Aut&Miss]**

**Purpose:** If [Aut&Miss] is chosen then the relay goes on when no material edge is detected and the controller is in Automatic Operation.

**Setting:** **Automatic Operation [Auto]**

**Purpose:** If [Auto] is chosen then the relay goes on when the controller is in Automatic Operation.

**Setting:** **[Centre]**

**Purpose:** If [Centre] is chosen then the relay goes on as soon as the motor drive stands still after a center run.

**Setting:** **[Disabled]**

**Purpose:** If **[Disabled]** is chosen then the relay function is disabled. The relay will never go on.

### Digital Input 1, 2, 3 or 4 Modes [Input 1...4]

These are actually four parameters one for each digital input

**Purpose:** This parameter determines the functions of the digital inputs.  
The user can choose between seven settings.

**Setting:** **Edge Triggered Automatic Mode [Edge→Aut]**

**Purpose:** The controller switches either to automatic or manual operation depending in which mode the controller currently is. The switching is taking place when a **rising edge** is detected on the digital input. (Default setting for dig. input 1)

**Setting:** **Level Controlled Automatic Mode [Lv→Auto]**

**Purpose:** The controller switches either to automatic or manual operation depending on the voltage level at the digital input. If the voltage is high then the controller switches to Automatic otherwise to Manual Operation.

**Setting:** **Drive to Center Position [Centre]**

**Purpose:** If **[Centre]** is chosen then the motor drive moves to the centre position. The event is edge triggered. (Default setting for dig. input 2)

**Setting:** **Decrease Reference Value or Move to the Left [-Ref/←]**

**Purpose:** The controller behaves in two different ways depending on the current operation mode. If the controller is in manual operation then the motor drive moves to the left respectively to the retracted position. If it is in automatic mode then the reference value is decreased. Default setting for dig. input 3)

**Setting:** **Increase Reference Value or Move to the Right [+Ref/→]**

**Purpose:** The controller behaves in two different ways depending on the current operation mode. If the controller is in manual operation then the motor drive moves to the right respectively to the extended position. If it is in automatic operation then the reference value is increased.  
(Default setting for dig. input 4)

**Setting:** **Lock Guide [Lock]**

**Purpose:** The motor drive is immediately locked when this parameter is chosen and the digital input voltage is high.



Dig. Input *Lock*, Operation State *Automatic* and Parameter *Auto→Man* work in a combinative manner. Their interdependency is described in the following table:

Dig. In. Lock	Op. State Automatic	Parameter Auto→Man	Function
0	inactive	Centre	Move to middle position
0	active	irrelevant	Automatic operation
1	inactive	Manual	Stop at actual position
1	inactive	Centre	Move to middle position
1	active	irrelevant	Stop at actual position

**Setting:** **Reset of Reference Value [ResetRef]**

**Purpose:** This function resets the reference value to 0, if a positive signal edge is applied to the digital input.

**Setting:** **Disabled**

**Purpose:** With [Disabled] parameter the digital input is disabled.

## DLS

**Purpose:** If you use a DLS2 sensor, you have to set the correct installation direction. You can only connect one DLS2 sensor.

**The user can choose between three settings.**

**Setting:** **[none]**

**Purpose:** There is no DLS2 sensor connected

**Setting:** **[left]**

**Purpose:** The DLS2 sensor is installed on the left-hand side (in direction of the moving web)

**Setting:** **[right]**

**Purpose:** The DLS2 sensor is installed on the right-hand side (in direction of the moving web)

**Password**

**Purpose:** The web guide controller can be protected from unauthorized access by means of password. If *Password Yes* is chosen, the system will request the password to change parameters and other setting. The password itself can't be changed. It is always **3231**

The user can choose between two settings.

**Setting:**

**Purpose:** The Password protection is deactivated (default setting)

**Setting:**

**Purpose:** The Password protection is activated

**Language**

**Purpose:** This parameter determines the displayed language.

The user can choose between two languages.

**Setting:**

**Purpose:** If [English] is chosen, the display shows all texts in English. The web browser is always in English.

**Setting:**

**Purpose:** If [German] is chosen, the display shows all texts in German.

**LCD-Contrast [Contrast]**

**Purpose:** The parameter [Contrast] changes the contrast of the LCD to achieve optimal readability.

**Range:** 1 to 100                      **Default:** 65

**Increment:** 1                              **Unit:** [%]

**Unit System [Unit Sys]**

**Purpose:** This parameter determines the unit system used.

The user can choose between two settings.

**Setting:**

**Purpose:** If [Metric] is chosen, the controller displays all data in metric units.

**Setting:**

**Purpose:** If [Imperial] is chosen, the controller shows all data in imperial units.

### Gain Setting [Gain]

**Purpose:** This parameter defines the gain of the feedback value.

**Range:** 0.02 to 2.00 **Default:** 0.20

**Increment:** 0.01 **Unit:** [ - ]

### Adjusting Correction Speed [AdjSpeed]

**Purpose:** This parameter determines the maximum used speed.

**Range:** 1 to 100 **Default:** 100

**Increment:** 1 **Unit:** [%]

### Power Modes [Power ON]

**Purpose:** This parameter determines the operation mode after power on.  
The user can choose between three behaviours.

**Setting:**

**Purpose:** The controller goes to Manual Operation Mode after power on.

**Setting:**

**Purpose:** The controller goes to Automatic Operation Mode after power on.

**Setting:**

**Purpose:** The controller restores the operation mode that was previously chosen before power off.

### Behaviour when leaving Automatic Mode [Auto→Man]

**Purpose:** This parameter determines the behaviour of the controller leaving the automatic mode.

The user can choose between two behaviors.

**Setting:**

**Purpose:** The controller stops guiding. The motor drive is locked at the current position (Manual Mode).

**Setting:**

**Purpose:** The controller stops guiding. Afterwards the motor drive moves to the center.

### Home Position [Home Pos]

**Purpose:** This parameter determines the position of the actuator spindle in its retracted position. An actuator stops at this position and moves no further backwards.

**Range:** 0.0 to 300.0      **Default:** 0.0

**Increment:** 0.1      **Unit:** [mm]

**Condition:** This parameter appears on the display only if an actuator / winderGLIDE is connected to the controller.

### Middle Position [Mid Pos]

**Purpose:** The [Mid Pos] parameter determines the center position of the actuator spindle. An actuator stops at this position, if you press the center key . In Automatic Operation this parameter has no meaning.

**Range:** 0.0 to 300.0      **Default:** 62.5 <sup>4)</sup>

**Increment:** 0.1      **Unit:** [mm]

<sup>4)</sup> The default value is dependent on the used actuator

**Condition:** This parameter appears on the display only if an actuator / winderGLIDE is connected to the controller.

### Maximal Position [Max Pos]

**Purpose:** This parameter determines the limit for the extended position. An actuator stops at this position and moves no further forward.

**Range:** 0.0 to 300.0      **Default:** 125.0 <sup>4)</sup>

**Increment:** 0.1      **Unit:** [mm]

<sup>4)</sup> The default value is dependent on the used actuator

**Condition:** This parameter appears on the display only, if an actuator / winderGLIDE is connected to the controller.

### Actuator [Actuator]

- Purpose:** The parameter [Actuator] determines the control logic of the web guide controller BKS309.
- Condition:** This parameter appears on the display only if an actuator / winderGLIDE is connected to the controller.  
The user can choose between two control directions.
- Action:**
- Purpose:** [Left] is the control direction when the actuator is mounted on the left side of the unwind/rewind station seen in direction of the running web
- Action:**
- Purpose:** [Right] is the control direction when the actuator is mounted on the right side of the unwind/rewind station seen in direction of the running web

### [IP Addr]

- Purpose:** The parameter assigns an IP address to the controller. This enables the user to communicate via a web browser with the controller that is imbedded in a network. The IP address must be entered in 4 separate blocks (IP Bl. 1; IP Bl. 2; IP Bl. 3; and IP Bl. 4)
- Range:** 0 to 255      **Default:** 192.168.0.090
- Increment:** 1      **Unit:** [-]

### [Subnet]

- Purpose:** The parameter assigns the Subnet Mask of the controller in the Ethernet network. This enables the user to communicate via a web browser with the controller. The Subnet Mask must be entered in 4 separate blocks (Sub. Bl 1; Sub. Bl 2; Sub. Bl 3; and Sub. Bl 4).
- Range:** 0 to 255      **Default:** 255.255.255.0
- Increment:** 1      **Unit:** [-]

### Factory Settings [Default]

- Purpose:** This menu point is a command. It resets the parameters to the factory settings.

The user can choose between two actions.

**Action:** [Not Set]



**Purpose:** If [Not Set] is chosen, all parameters stay as set by the user.



**Action:** [Yes]

**Purpose:** If [Yes] is chosen, the default parameters are loaded.

## 8.4 System parameters

To access the menu for system parameters, the web guide controller must be in the Manual Mode.

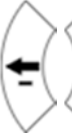
Press the  and  buttons together for longer than 3 sec. The LED will light and the first parameter will be displayed

With the   buttons the parameter list can be scrolled up and down. By pressing the  button again you will enter the parameter setting mode. The select parameter

on the display flashes indicating that it can be modified with the buttons

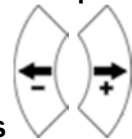

To save the changes, press .

## 8.5 List of System parameters

description						
Parameter	LCD	Unit	Min	Max	Selection	Factory
Offset Centre	Offset><	-	-	-	-	4)
Position Detection	PosDetec	-	-	-	Potential One Hal Two Hal	4)
Centre Position	CentrPos	steps	0.0	10'000	-	4)
Right Limit	RightLim	steps	0.0	10'000	-	4)

description						
Parameter	LCD	Unit	Min	Max	Selection	Factory
Drive Direction	DriveDir	-	-	-	Standard Invers	Standard
Actuator type	winderGL	-	-	-	BKS.D.3.125 BKS.D.3.200 BKS.D.3.300  BKS.D.4.125 BKS.D.4.200 BKS.D.4.300  BKS.D.6.200 BKS.D.6.300  BKS.D.7.200 6) BKS.D.7.300 6)	4)
Acceleration	Accelera	ms	40	5'000	6)	80

Table 8: System parameters

- Permanent pressing of the buttons expedites the changing speed.
- 2) The display shows the unit of measure that was previously selected.
- 3) Parameter only used in FMS-winderGLIDE series of the sizes BKS.D.3, BKS.D.4 und BKS.D.7. If you are using an actuator of the FMS-winderGLIDE series BKS.D.4 you have to use the system parameters similar to the BKS.D.3
- 4) The default value is dependent on the actuator used
- 5) System parameters are not reset, if the default function is used
- 6) only in combination with BKS309.R.DC oder BKS309.W.DC

## 8.6 Description of system parameters

### Modification of system parameters



System parameters are factory preset and should not be modified without contacting the service department of FMS. An unauthorized change can cause malfunctions in the system or damage in the machine.

### Offset Centre [Offset><]

**Purpose:** This parameter adjusts the position of a steering frame exactly to the centre.

### Position Detection [PosDetec]

**Purpose:** This parameter determines what devices that are used to detect the limit positions.

The user can choose between three types.

**Type:** [Potentio]

**Purpose:** A potentiometer is used to detect the Home position, Middle Position and Maximum Position. It is automatically set, if an actuator / winderGLIDE of the type BKS.D.3 or BKS.D.4 is used.

**Type:** [One Hall]

**Purpose:** One hall sensor is used to detect the Home position, Middle Position and Maximum Position.

**Type:** [Two Hall]

**Purpose:** Two hall sensors are used to detect the Home position, Middle Position and Maximum Position.

### Centre Position [CentrPos]

**Purpose:** The [CentrPos] parameter is only used with the position detection system based on hall sensors. For all other position detection system this parameter is not used and hence not displayed. The parameter determines the center position of the actuator spindle in motor steps (measured from the left reference position). The actuator stops at this position, if you press the center key . In Automatic Operation this parameter has no meaning.

### Right Limit [RightLim]

**Purpose:** The [RightLim] parameter is only used with the position detection system based on hall sensors. For all other position detection system this parameter is not used and hence not displayed. The parameter limits the maximum travel to the right side of the actuator spindle in motor steps (measured from the left reference position). In the operation or in manual mode this limit will never be exceeded

### Drive Direction [DriveDir]



**Purpose:** This parameter determines the guiding orientation of the controller. Usually turn stepper motors clockwise. This setting changes the turning direction of the motor. There are two other possibilities to change the guiding direction:

- a) Changing the electrical polarization of the stepper motor
- b) Mounting the actuator in the opposite direction

**The user can choose between two settings**

**Setting:**

**Purpose:** [Standard] is chosen when standard motors and standard frames are used.

**Setting:**

**Purpose:** [Invers] is chosen when motors are used that turn anticlockwise. If a FMS actuator of the type winderGLIDE is used, the controller sets the drive direction automatically.

### Actuator Type [winderGL]

**Purpose:** This parameter determines the used actuator type. The product name of FMS actuators is winderGLIDE.

**The user can choose between three types.**

**Type:**

**Purpose:** If type [D.3.125] or [D.4.125] or [D.6.125] the max. stroke is set to 125mm (4.92in).

**Type:**

**Purpose:** If type [D.3.200] or [D.4.200] or [D.6.200] or [D.7.200] the max. stroke is set to 200mm (7.87in).

**Type:**

**Purpose:** If type [D.3.300] or [D.4.300] or [D.6.300] or [D.7.300] the max. stroke is set to 300mm (11.81in).



Actuator FMS-winderGLIDE BKS.D.7

This actuator is driven by a DC motor. Additional parameters will be activated automatically.

### Acceleration [Accelara]

**Purpose:** The acceleration ramp is only used in combination with the BKS.D.7. This parameter determines the acceleration and deceleration ramp of the motor. The DC motor driver uses the same ramp for both. The parameter defines the required time span to reach the maximum speed and vice versa.

**Setting:** 40 bis 5'000  
**Increment:** 1

**Default:** 80  
**unit:** [ms]

## 8.7 Reset to factory settings

Factory settings of your BKS309 web guide controller can be reset either via the operating parameter menu.

Alternatively, you can follow the procedure below

Holding the two buttons   while powering-up the controller.

## 9 Configuration via web browser

The BKS309 web guide controller can be embedded in an Ethernet network and the parameter setting can be done over this network by means of a web browser (Internet Explorer 7).

The devices have a static IP-address that can be set over the user interface. The IP-address is not automatically received over DHCP.

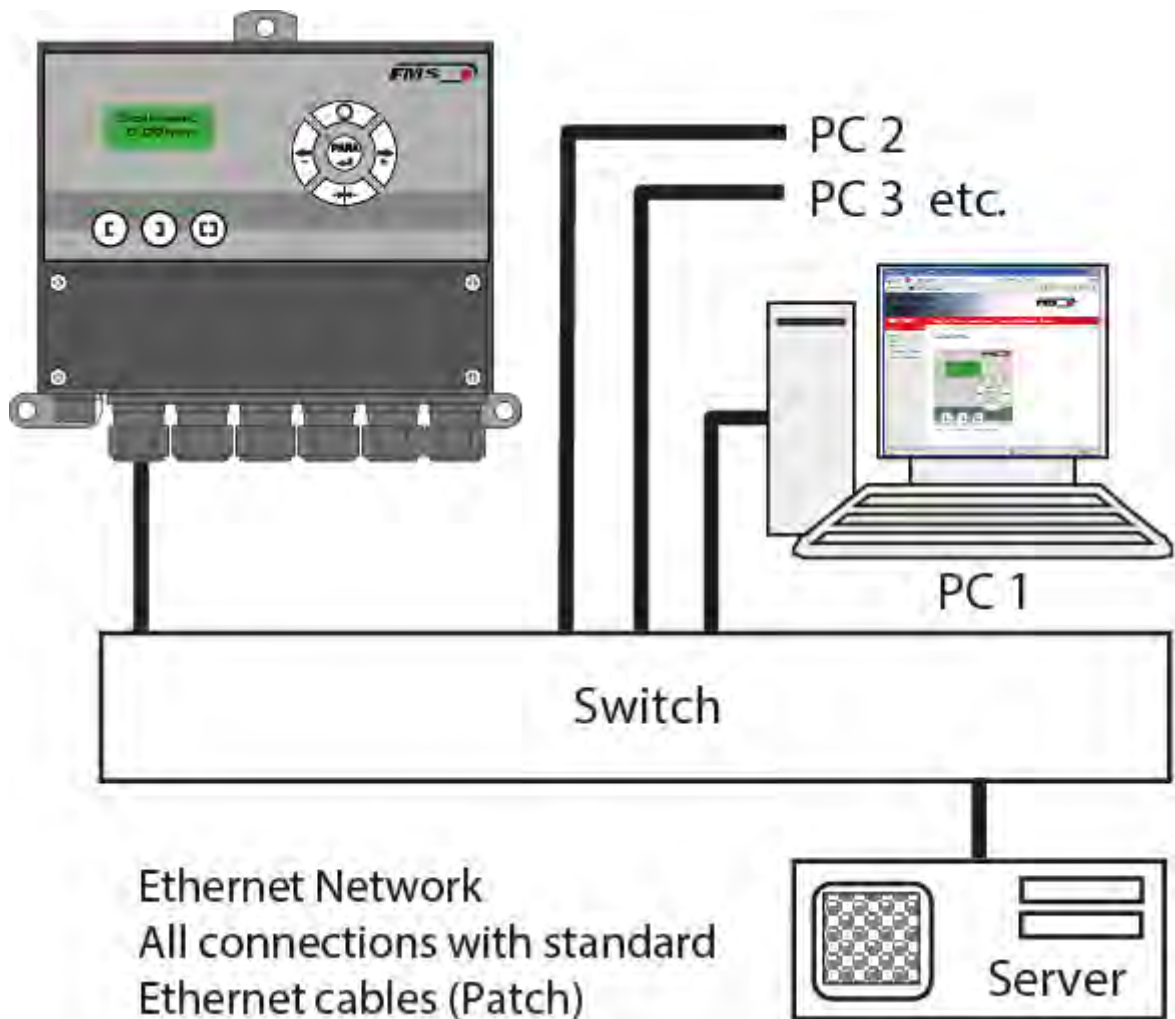

Figure 13: LAN

BKS309\_BA\_manual.ai



Figure 14: Home

Home.jpg

The main navigation is on the left-hand side of the window.



Figure 15: Remote Control

Remote Control

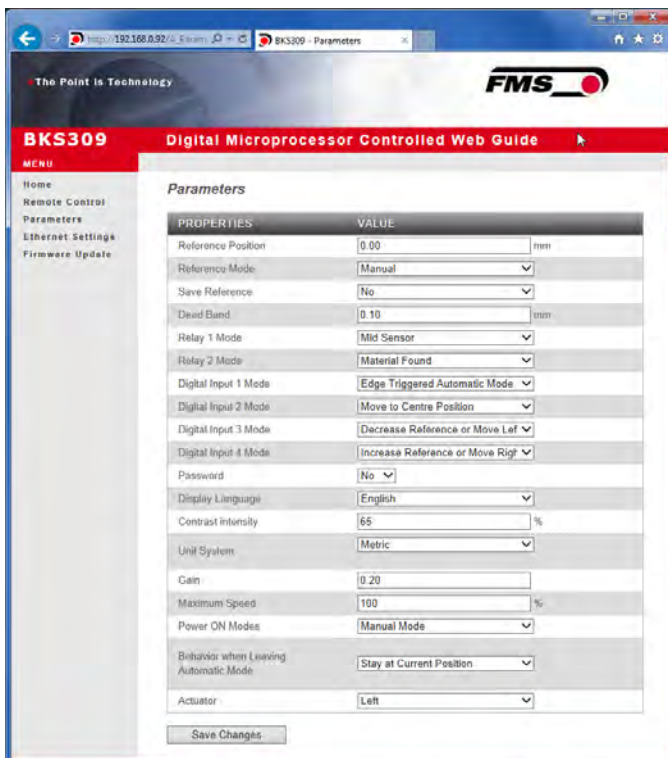

Figure 16: list of operating parameters

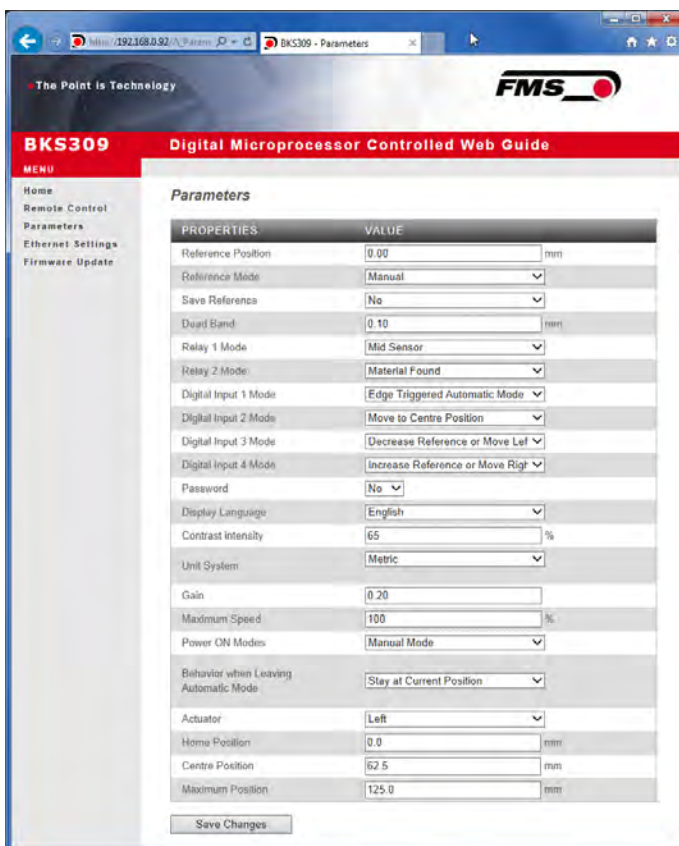

Figure 17: list of operating parameters for actuators of the FMS-winderGLIDE series

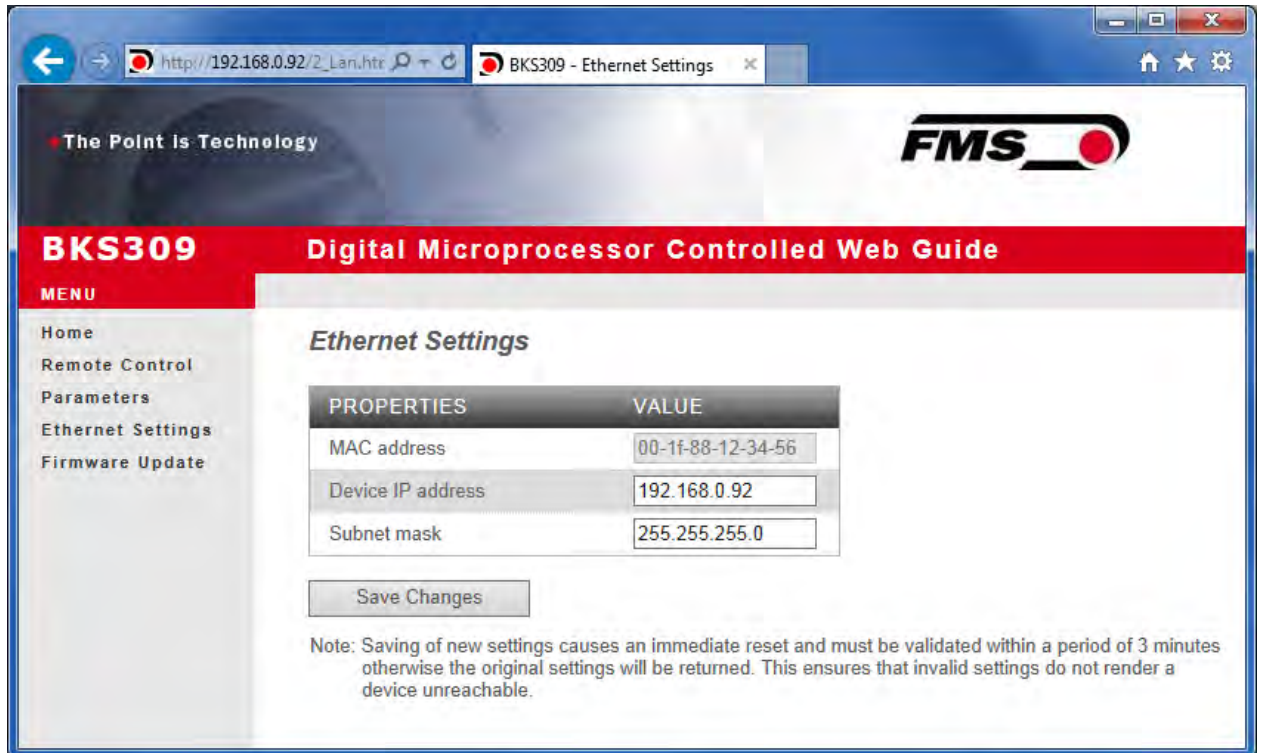

Figure 18: Ethernet Settings

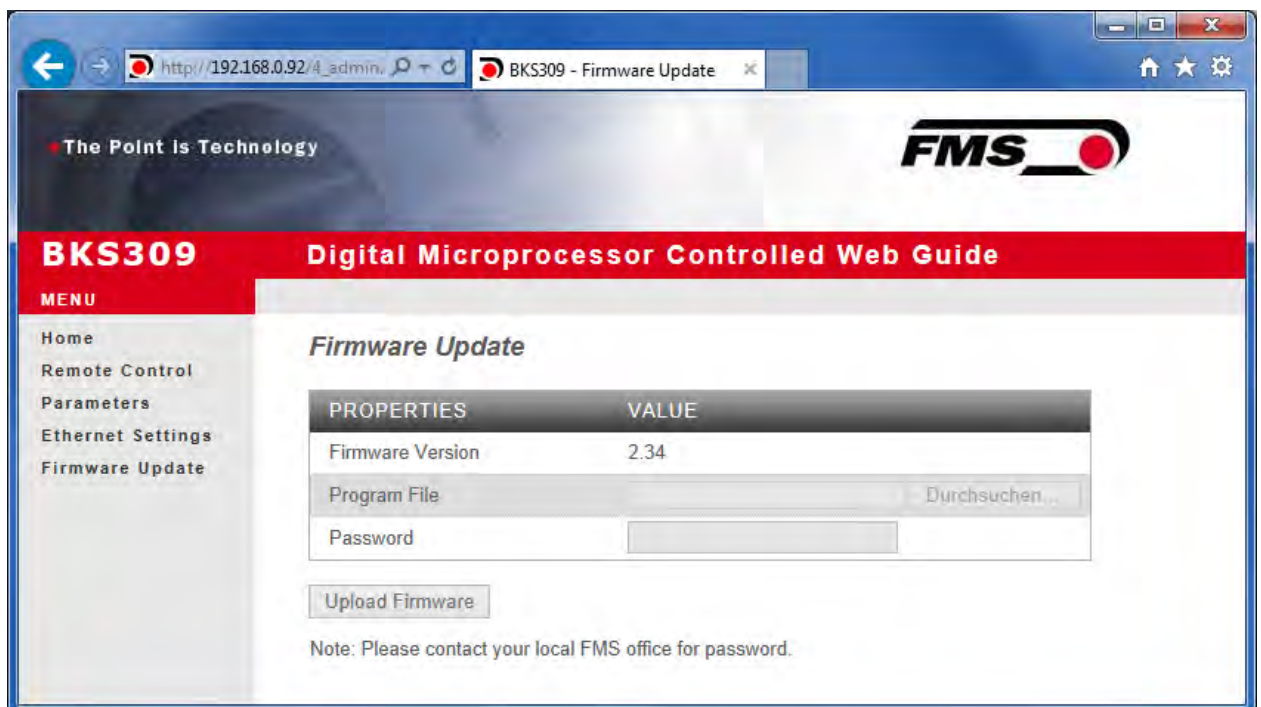
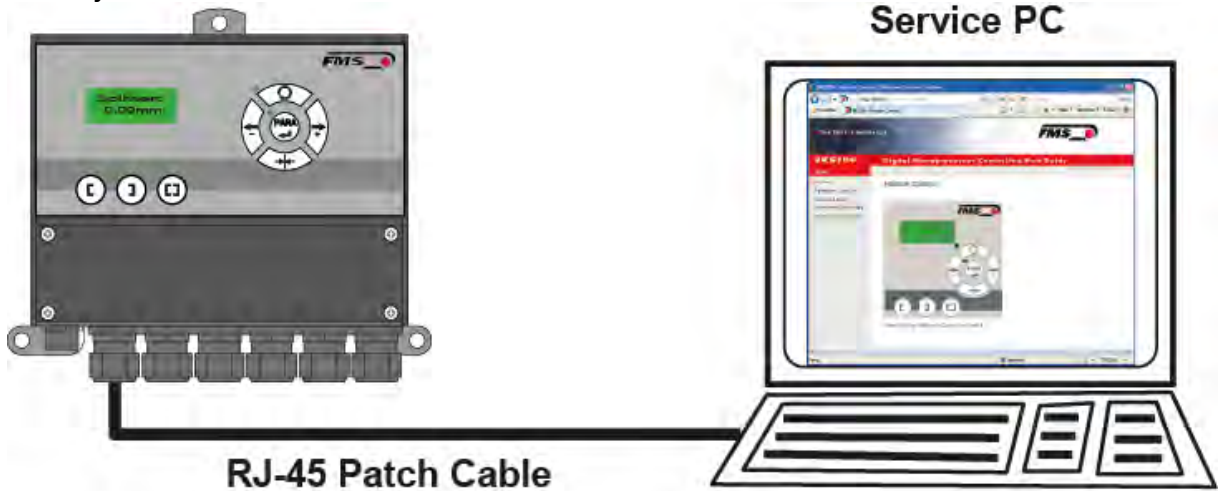

Figure 19: Firmware

## 9.1 Peer-to-Peer connection

The parameter setting can also be carried out with a desktop or laptop computer directly connected to the BKS309 Controller.



*Figure 20: Peer-to-peer*

Before the parameterization of the BKS309 it must be certain that the BKS309 uses an IP address in a static block. For the integration of a BKS309 web guide controller in your Ethernet network please contact your IT system administrator.

Once the BKS309 was integrated in the network you can address the device e.g. with <http://192.168.0.92>.

### Setup for OS Window 7

- Connect PC and BKS309 Controller with a “RJ-45 patch cable”
- Power-up PC and BKS309 Controller
- In order to locate the BKS309 System your PC must be configured with a “static” IP-address. Click on the Windows button (lower left-hand corner).
- Click on Control Panel
- Double click on Network

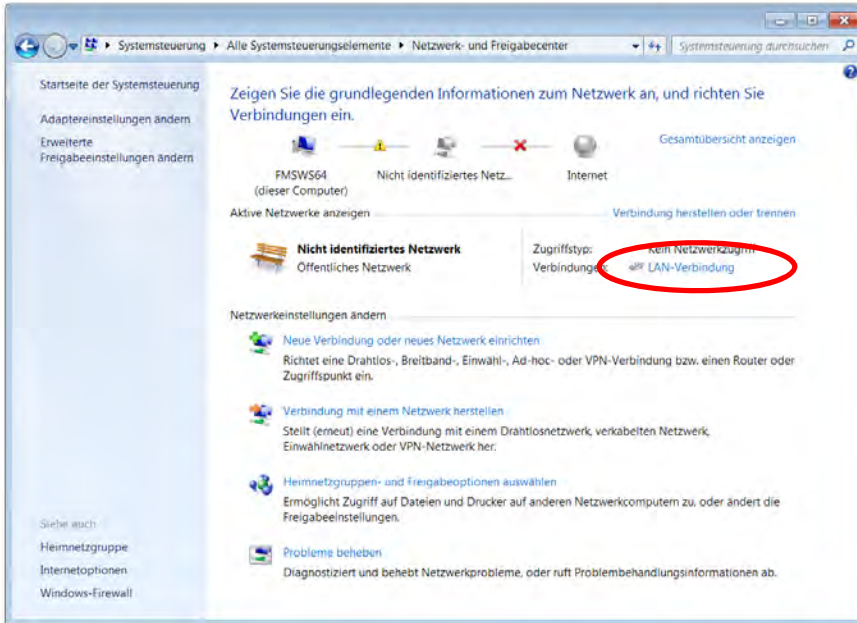

- Double click on “Local Area Network”. The dialog box “Status of LAN connection” will open up.

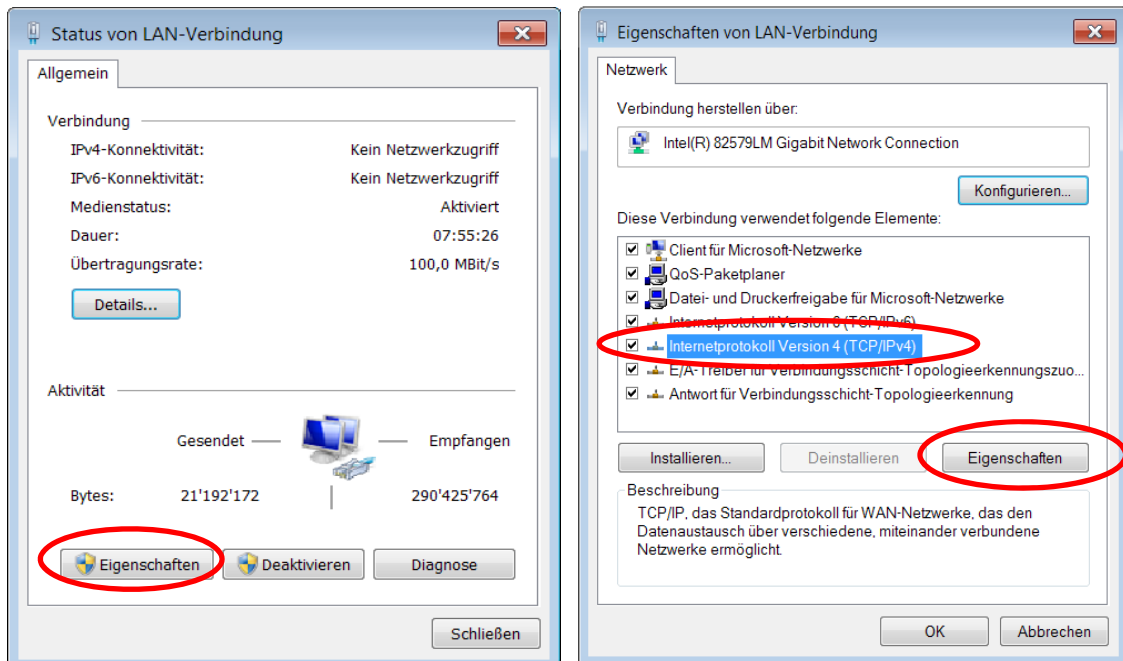

- Click on Properties
- On the next dialog box select the network adapter that is used for the connection. In our case “Internet protocol version 4 (TCP/IP)”
- Click on Properties. The following dialog box “Internet protocol Version 4 (TCP/IPv4) Properties” will appear.



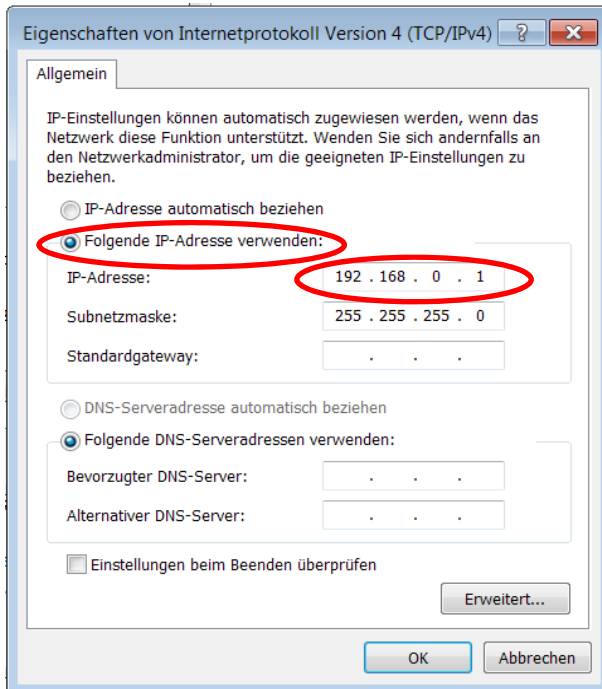

- Select the radio button “Use the following IP address:”
- Enter the IP address for the computer that could be 192.168.0.1
- In the Subnet mask, enter 255 255 255 000, as shown above.
- Click the “OK” button.
- Close all windows

Start your web browser (Microsoft Internet Explorer, Mozilla Firefox or similar)

The default IP address for the BKS309 is 192.168.000.090 as long as it was not changed over the operating penal. Enter the IP address e.g. with <http://192.168.000.090> in the address bar and hit the Enter key.

If a different IP address and subnet mask is configured at the BKS309 make sure that the computer is setup appropriate.

Once you return to your office, don't forget to reconfigure your PC to “Automatic assignment of the IP-address” (see last dialog box).

## 10 Dimensions

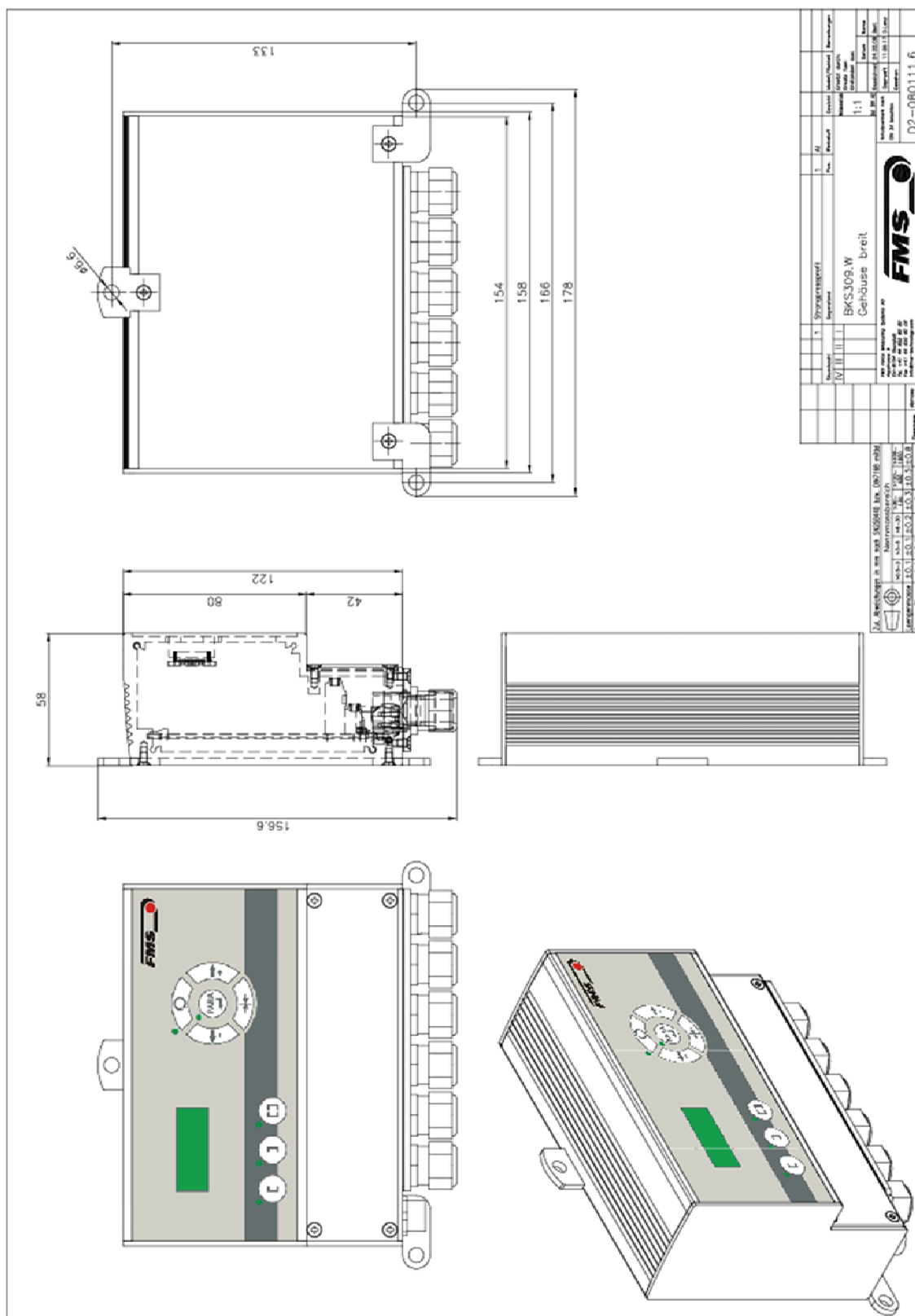

Figure 21: dimensions BKS309.W - Wall mount

BKS309\_BA\_Manual.ai

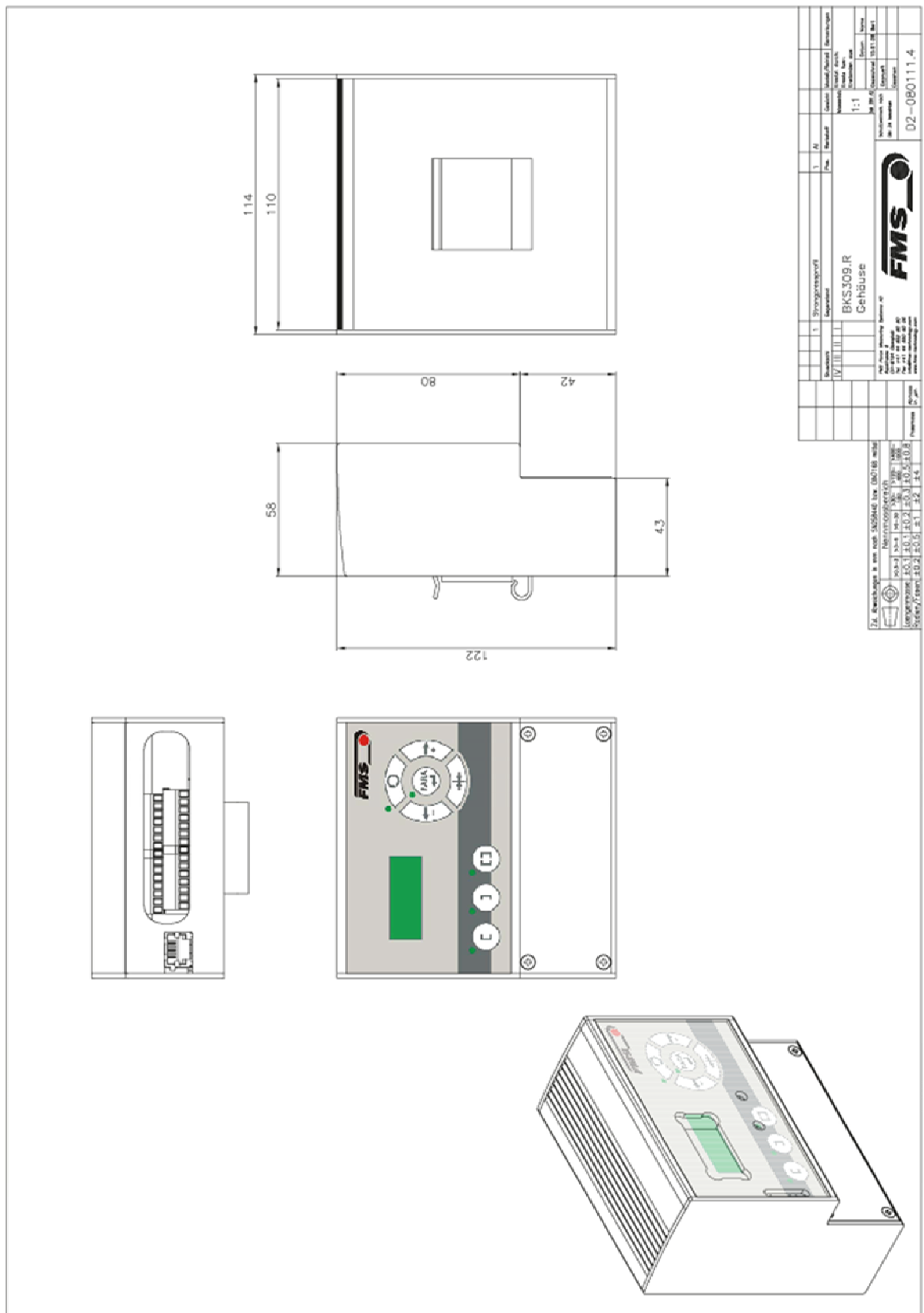

Figure 22: dimensions BKS309.R - DIN-rail

BKS309\_BA\_Manual.ai

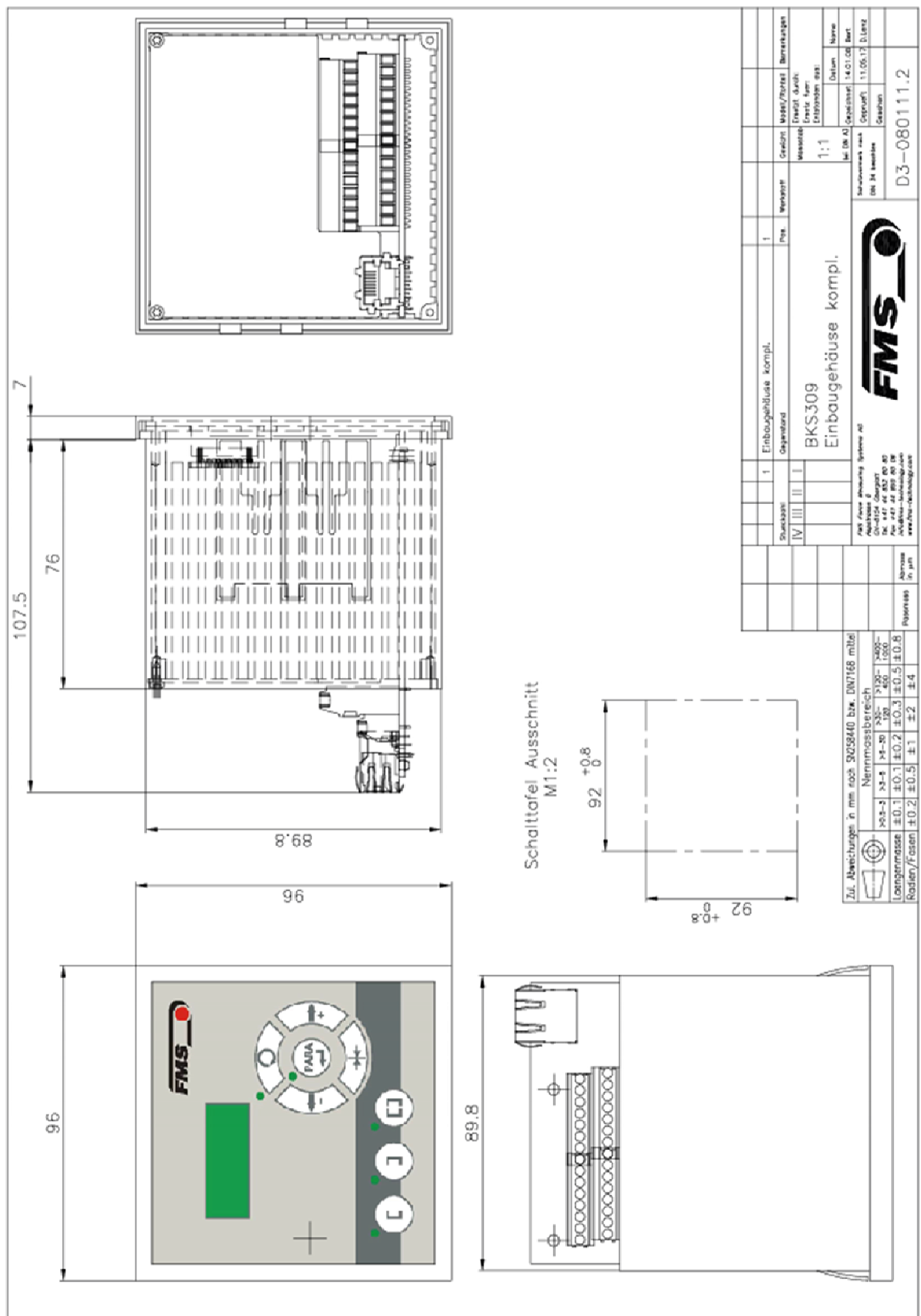

Figure 23: dimensions BKS309.S – panel integrated BKS309\_BA\_Manual.ai

## 11 Technical data

Description	
Cycle time processor	1ms
Drive of steering frame	Stepper motor. Power amplifier 24V integrated in housing
Dead band	0 to 2mm, adjustable in 0.1mm steps
Position reference	±5mm, adjustable in 0.1mm steps
Control modes	edge left / edge right / center guiding / line guiding
Interface	Web browser Ethernet Explorer 7 or higher
Operation	push buttons
Analogue inputs	2 inputs 0 to 10V (for material sensors)
Digital inputs	4 dig. inputs 24VDC galvanic insulated
Relay outputs	2 relay outputs. DC: 220V/2A/60W; AC:250V/2/62.3VA
Supply voltage	24VDC (18 to 30VDC)
Temperature range	-10 to 60 °C (14 bis 140 °F)
Protection class	BKS309.R IP 30 BKS309.W IP65 BKS309.S IP00

Table 9: technical data

## 12 Trouble Shooting

<b>Description</b>		
<b>Error</b>	<b>Cause</b>	<b>Corrective action</b>
Edge outside detection band	Edge has moved outside the sensor detection band	Adjust sensor more accurately to the web edge; Adjust reference position less during automatic operation
BKS guides web edge immediately out of the sensor	Sensor is mounted on the wrong side	Mount sensor to the correct side (right sensor for „Edge right“, etc.)
	Sensor is connected to the wrong socket	Connect sensor plug to the correct socket (left plug to left socket, etc.)
Steering frame does not move	No signal; sensor not correctly connected	Connect sensor correctly according to screw terminal arrangement and installation guide
	No signal; cable interruption	Replace cable or send sensor to FMS
	No signal; sensor defect	Send sensor to FMS; use other sensor
No response of the interface	Wiring not correct	Check wiring
Display shows nothing, frame doesn't react	Power supply defect	Check or correct power supply installation
	Electronic control unit defect	Contact FMS customer service
Frame moves abrupt to one of the end positions	Stepper motor driver defective	Exchange actuator of the frame. Contact FMS service department for spare parts and installation guide.
Edge outside detection band	Edge has moved outside the sensor detection band	Adjust sensor more accurately to the web edge; Adjust reference position less during automatic operation

Table 10: Trouble Shooting





**FMS Force Measuring Systems AG**  
Aspstrasse 6  
8154 Oberglatt (Switzerland)  
Tel. 0041 1 852 80 80  
Fax 0041 1 850 60 06  
info@fms-technology.com  
www.fms-technology.com

**FMS USA, Inc.**  
2155 Stonington Avenue Suite 119  
Hoffman Estates,, IL 60169 (USA)  
Tel. +1 847 519 4400  
Fax +1 847 519 4401  
fmsusa@fms-technology.com

**FMS (UK)**  
Aspstrasse 6  
8154 Oberglatt (Switzerland)  
Tel. +44 (0)1767 221 303  
fmsuk@fms-technology.com

**FMS (Italy)**  
Aspstrasse 6  
8154 Oberglatt (Switzerland)  
Tel. +39 02 39487035  
fmsit@fms-technology.com