



# Operating Manual BKS309.W.M

## Digital Web Guide Controller with Integrated Functions for Motorized Traverse

Document version 1.30 08/2018 NS  
Firmware Version V2.43



Diese Bedienungsanleitung ist auch in Deutsch erhältlich.  
Bitte kontaktieren Sie Ihren nächstgelegenen FMS Vertreter.

# Inhalt

<b>1</b>	<b>TARGET GROUPS</b> .....	<b>3</b>
<b>2</b>	<b>SAFETY INSTRUCTIONS</b> .....	<b>3</b>
2.1	DESCRIPTION CONDITIONS .....	3
2.2	LIST OF SAFETY INSTRUCTIONS.....	4
<b>3</b>	<b>SYSTEM AND FUNCTIONAL DESCRIPTION</b> .....	<b>5</b>
<b>4</b>	<b>INSTALLATION AND WIRING</b> .....	<b>6</b>
4.1	INSTALLATION OF THE STEERING FRAME – FMS WEBMASTER.....	6
4.2	INSTALLATION OF THE ACTUATOR – FMS WINDERGLIDE .....	7
4.3	INSTALLATION OF THE TRAVERSE .....	7
4.4	INSTALLATION OF THE SENSORS.....	8
4.5	INSTALLATION OF THE CONTROLLER .....	8
4.6	CONNECTING TERMINAL .....	9
4.7	ELECTRICAL CONNECTION OF MATERIAL SENSORS .....	10
4.8	ELECTRICAL CONNECTION OF DIFFERENT FMS STEERING FRAMES AND ACTUATORS.....	FEHLER! TEXTMARKE NICHT DEFINIERT.
<b>5</b>	<b>OPERATION</b> .....	<b>12</b>
5.1	OPERATING PANEL .....	12
5.2	DISPLAY.....	12
5.3	MENU LEVELS .....	13
5.4	INITIAL START-UP AND BASIC SETTINGS .....	14
<b>6</b>	<b>BASIC FUNCTIONS OF THE CONTROLLER</b> .....	<b>16</b>
6.1	AUTOMATIC MODE .....	16
6.2	MANUAL MODE .....	17
6.3	CHANGING AND STORING POSITIONS OF THE ACTUATOR .....	17
6.4	SELECTION OF THE GUIDING LOGICS.....	18
<b>7</b>	<b>BASIC FUNCTIONS OF THE MOTORIZED TRAVERSE IN MANUAL MODE</b> .....	<b>19</b>
7.1	RETRACT THE SENSORS [RETRACT].....	19
7.2	AUTOMATICALLY DETECT THE WEB EDGE [DETECT] .....	19
7.3	APPROACHING THE HOME POSITION AS REFERENCE [REFRUN] .....	19
7.4	SET AN ABSOLUTE ZERO POINT [SETZERPR] [SETZERPL] .....	19
7.5	REPOSITIONING THE TRAVERSES MANUALLY .....	21
<b>8</b>	<b>OPERATING PARAMETERS</b> .....	<b>23</b>
<b>9</b>	<b>SYSTEM PARAMETERS</b> .....	<b>32</b>
<b>10</b>	<b>TRAVERSE PARAMETERS AND FUNCTIONS</b> .....	<b>34</b>
<b>11</b>	<b>RESTORE DEFAULT SETTINGS</b> .....	<b>35</b>
<b>12</b>	<b>SETUP FOR CONNECTION TO A PC OR NETWORK</b> .....	<b>36</b>
12.1	CONNECTION VIA WEB BROWSER .....	37
12.2	SETTING UP A PEER-TO-PEER CONNECTION WITH A PC .....	41
<b>13</b>	<b>TROUBLE-SHOOTING</b> .....	<b>44</b>
<b>14</b>	<b>DIMENSIONS</b> .....	<b>46</b>
<b>15</b>	<b>TECHNICAL DATA</b> .....	<b>46</b>
<b>16</b>	<b>YOUR SETTINGS</b> .....	<b>FEHLER! TEXTMARKE NICHT DEFINIERT.</b>

# 1 Target Groups

This manual addresses mechanics who will install and connect the single components and operators who will setup the machine and put it into operation. The following skills are required as per target group.

**Mechanics** (installation, assembly)

Knowledge of electrical and measuring techniques, basic mechanical skills (drilling, thread cutting, fastening technology, occupational health and safety.

**Operator** (configuration, start-up, operation)

Knowledge of the manufacturing processes and relevant parameters of the machine, occupational health and safety, basic knowledge of network technology (only required for optional LAN connection)

# 2 Safety Instructions

## 2.1 Description Conditions

a) Danger of health injury or loss of life



**Danger**

*This symbol refers to high risk for persons to get health injury or loss life. It has to be followed strictly.*

b) Risk of damaging of machines



**Caution**

*This symbol refers to information, that, if ignored, could cause heavy mechanical damage. This warning has to be followed absolutely.*

c) Note for proper function



**Note**

*This symbol refers to an important information about proper use. If not followed, malfunction can be the result.*

## 2.2 List of Safety Instructions



***Some contacts on the pc board are supplied with a power of 230V!  
Mortal danger! Disconnect the power supply before you open the housing!***

- ⚠ Proper function of the FMS web guide is only guaranteed with the recommended application of the components. In case of other arrangement, heavy malfunction can be the result.***
- ⚠ Local safety regulations and guidelines for the installation of electric equipment have to be obeyed. They are not taken into consideration in this operating manual. However, they have to be followed strictly.***
- ⚠ Bad electrical grounding may cause electric shocks to persons, malfunction of the total system or damage of the control unit! It is vital to ensure that proper grounding is set.***
- ⚠ The processor board is mounted directly behind the operation panel. Improper handling of the electronic boards may cause damage to the fragile equipment! Don't use rough tools such as screwdrivers or pliers! Operators handling the electronic boards must wear a well earthed bracelet in order to discharge static electricity***
- ⚠ Welding on the machine frame or components can cause defect on the electronic components. Always disconnect the controller from the power supply before welding.***

### 3 System and Functional Description

All instructions given in the manual are only valid for FMS components.

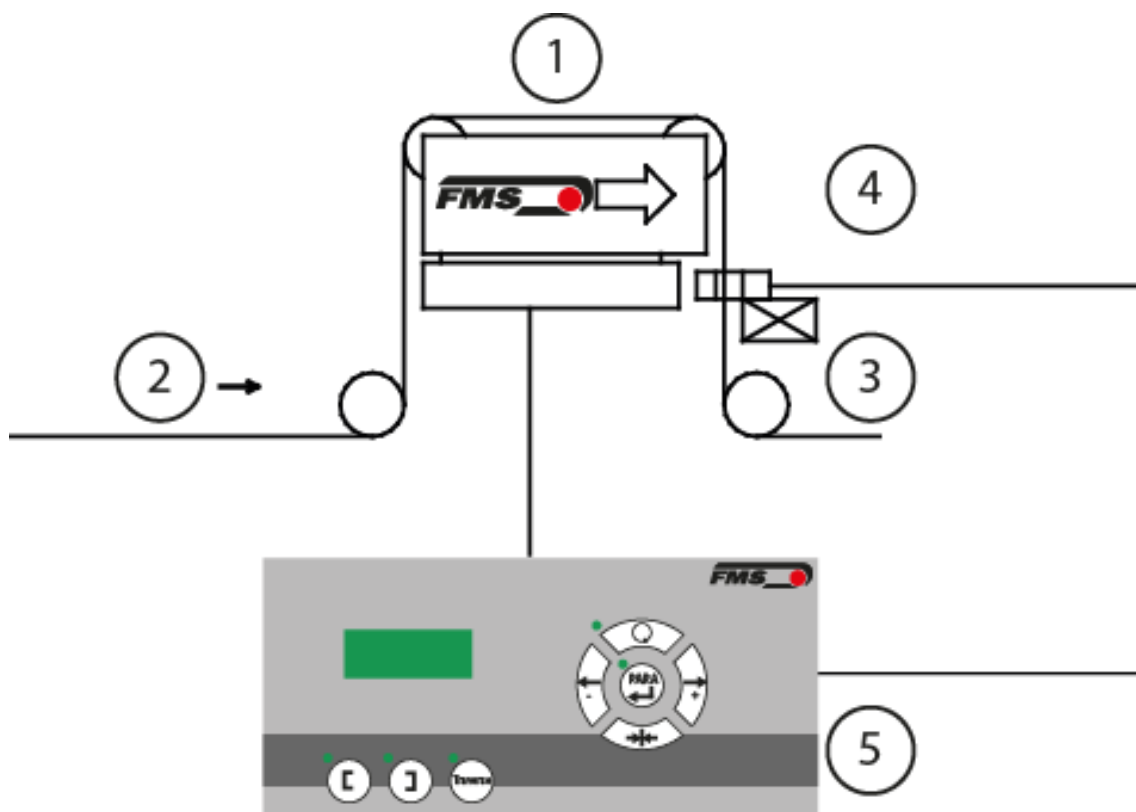

- |   |                            |   |                               |
|---|----------------------------|---|-------------------------------|
| 1 | Steering frame or actuator | 4 | One or two sensors            |
| 2 | Web and moving direction   | 5 | Operating panel of controller |
| 3 | Motorized traverse         |   |                               |

Illustration 1: Component arrangement

The illustration above shows a complete web guide control system with all required components. The sensors detect the material position and transfer their measuring results to the controller. The controller compares the actual measurement values with the stored reference values. If the deviation reaches a certain threshold value, the controller triggers the movement of the actuator.

A single sensor can be attached to a traverse. A maximum of two traverses can be connected to the controller. By means of the electric drives of the traverses, the sensor position can be adjusted via the control panel.

The BKS309.W.M controller can be used in combination with steering frames of the type webMASTER, with steering roller of the type webDIRECTOR and with actuators of the type winderGLIDE.

## 4 Installation and Wiring

### **Caution**

*Proper function of the controller is only guaranteed with the recommended arrangement of the components. Other arrangements can cause heavy malfunctions. Therefore, the installation instructions on the following pages must strictly be followed.*

### 4.1 Installation of the steering frame – FMS webMASTER

The mounting orientation of the steering frame (indicated by an arrow), must correspond with the direction of the moving web. The lower frame part is mounted with four M8 screws to the machine frame. The machine must be prepared to accept the M8 mounting screws. The steering frame must be electrically grounded. Connect the grounding bolt of the steering frame with a corresponding point of the machine. Use appropriate grounding cable for this connection.

#### Definition of the sensor alignment and designation of orientation in this manual

The sensors need to be mounted on the discharge side of the steering frame. "Left" and "right" always refers to the moving direction of the web.

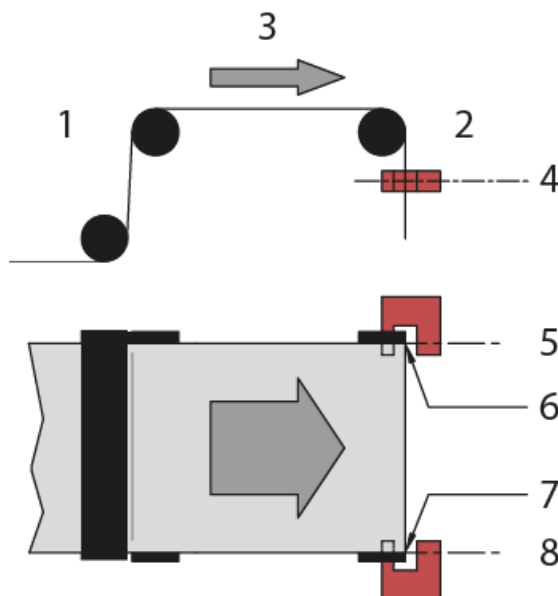

- |   |                             |   |                   |
|---|-----------------------------|---|-------------------|
| 1 | Entry side                  | 5 | Sensor axis left  |
| 2 | Exit side                   | 6 | Web edge left     |
| 3 | Moving direction of the web | 7 | Web edge right    |
| 4 | Sensor axis left            | 8 | Sensor axis right |

Illustration 2: Sensor alignment



### **Note**

*Make sure that the sensor(s) are connected properly to the electronic unit by*

**means of the delivered cables. For left / right orientation please refer to Fig. 2. If the connections are crossed over, malfunction can be the result.**



**Note**

**For optimum control results, the sensors have to be placed next to the exit roller of the steering frame. If the sensors are placed far from the steering frame, control dynamics will deteriorate.**

## 4.2 Installation of the actuator – FMS winderGLIDE

To provide the optimum function of the actuator you should mount it in a horizontal position. Attach the housing of the actuator to the machine frame. Bolt the moving part (connection rod) to the winding roll.

Different connectors (fork head, yoke, etc.) are available from the FMS accessories program.

Dimensions can be taken from the data sheet.

## 4.3 Installation of the traverse

The traverses have threaded mounting bores (M6) in their main body. You can use these to bolt the traverse to the machine frame or the steering frame. A drag chain and a safety guard for the sensor cable are part of the traverse.

If you have submitted the side of installation we have pre-installed all components to suite the assembly on the correct side of the machine.

If you want to use the traverse on the other side you have to disassemble / disconnect the following parts and re-install them on the correct side. The entire hardware is prepared for the mirrored assembly of these parts.

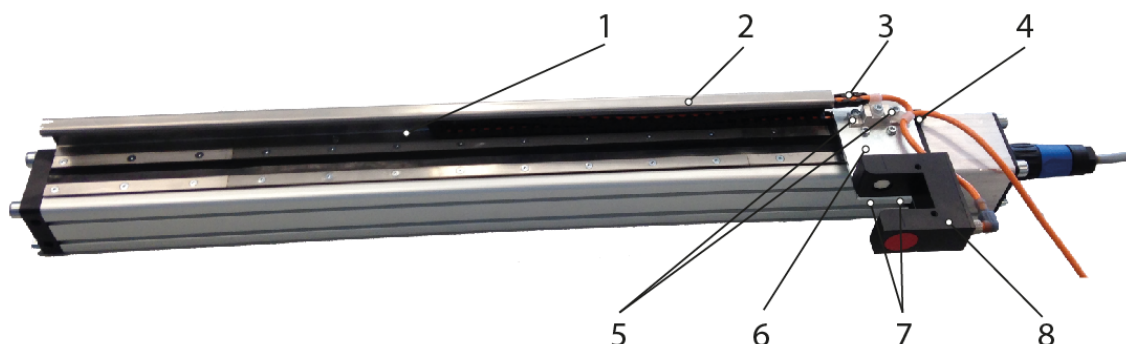

1	M3 screws for guard	2	Guard
3	Drag chain with sensor cable	4	Fixation screw for drag chain
5	Screws for cable support	6	Sensor bracket
7	Screws for sensor (from bottom side)	8	Sensor

Illustration 3: Motorized traverse

If you apply the motorized traverse on a winding / unwinding station, you have to provide an appropriate fixation.

Dimensions can be taken from the data sheet of the motorized traverse.

## **4.4 Installation of the sensors**

The matching installation brackets for the sensors can be ordered from our accessories program.

Dimensions of the sensors can be taken from the data sheet.

Please follow the instructions in the installation manual of the respective material sensor.

The DLS2 sensor cannot be combined with this controller.

## **4.5 Installation of the controller**

Make sure that the controller housing is installed in a safe and that the operator can easily reach. Install the housing on a wall or to a suitable place that provides enough stability.

You will find the dimensions of the housing on page 14.



## 4.6 Connecting Terminal

The connections are located underneath a cover plate on the front side of the controller. The plate can be lifted after removing the 4 screws.

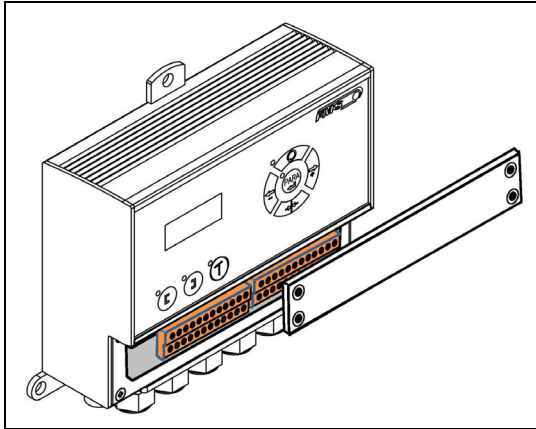

Illustration 4: Access to the connection terminal



### Note

**First connect the wires of the lower connection terminal (connection 1-15 and 41-64)**

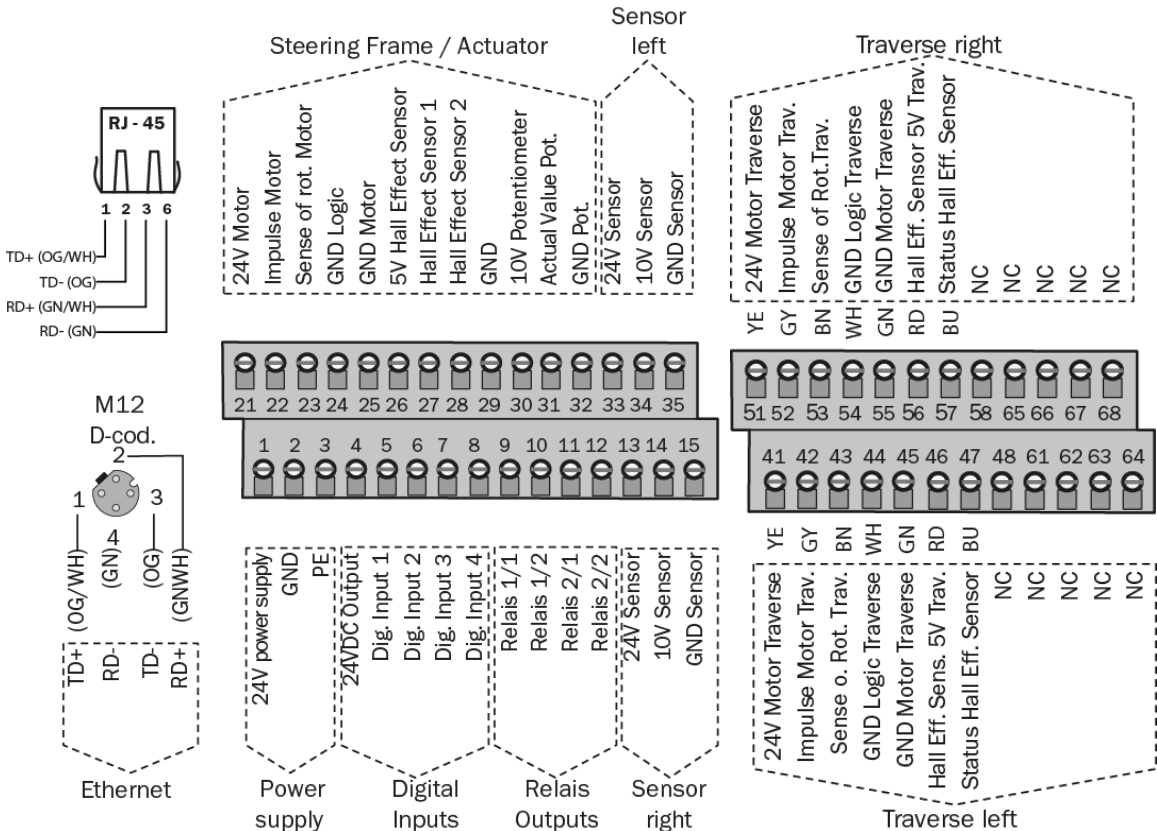

Illustration 5: Connecting terminal BKS\_309.ai



**Caution**

**Bad electrical grounding may cause electric shocks to persons, malfunction of the total system or damage of the control unit! It is vital to ensure that proper grounding is set.**

**4.7 Electrical connection of material sensors**

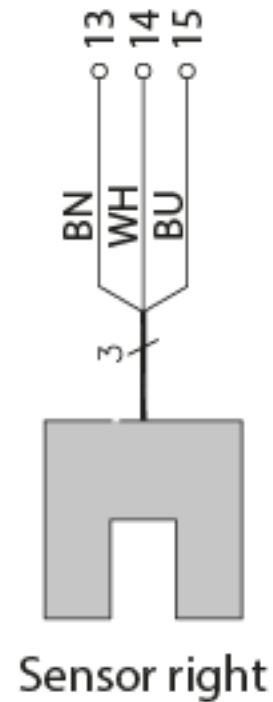
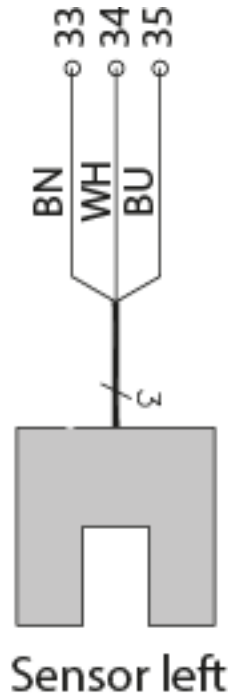

**4.8 Connecting FMS winderGLIDEs BKS.D.3, BKS.D.4 or a steering frame FMS webMASTER BKS030**

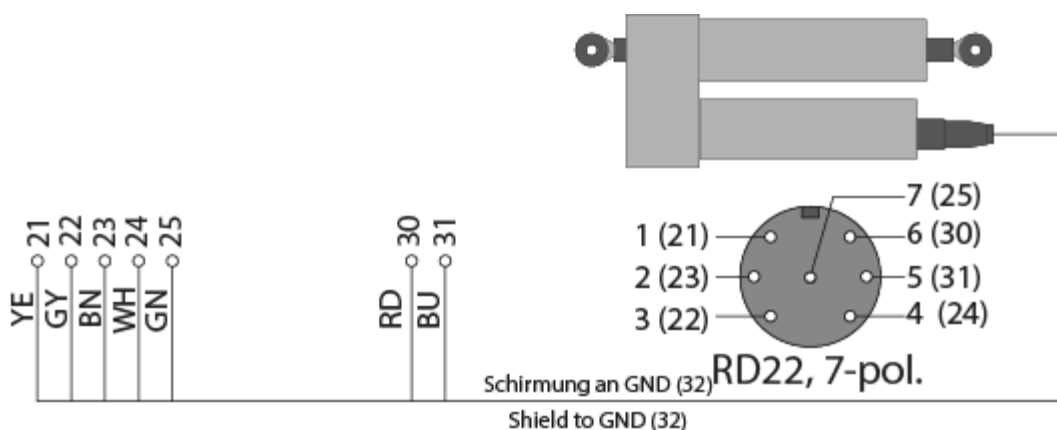

Illustration 6: Pin assignment of FMS winderGLIDEs BKS.D.3 and BKS.D.4 and terminal blocks of controller. The illustration shows a BKS.D.3 or BKS.D.4. The wiring of the BKS030 is similar. BKS309\_BA\_Manual.ai

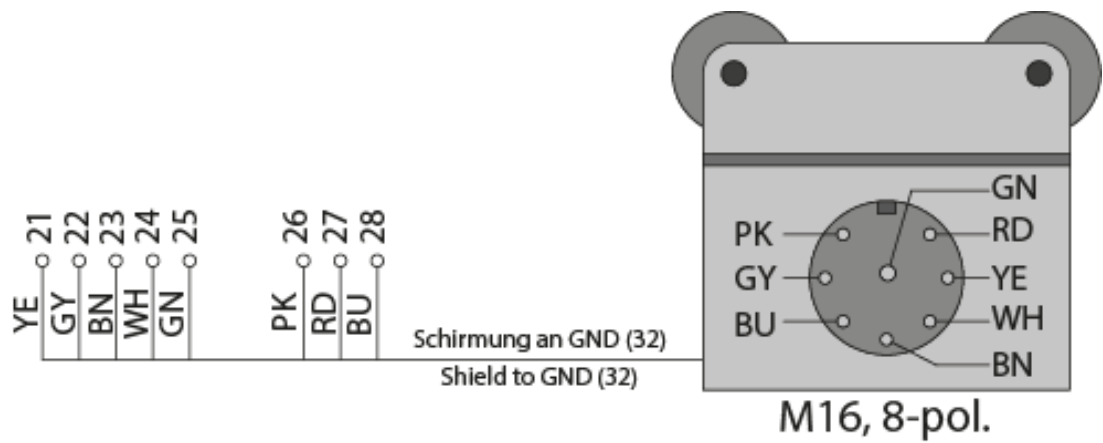

Illustration 7: Wiring diagram for BKS020.EE and BKS015.EE BKS\_309.ai

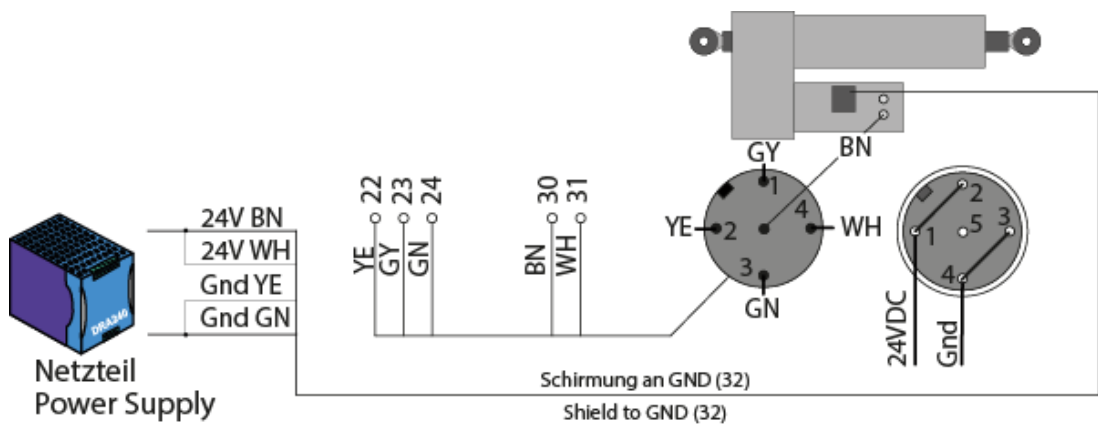

Illustration 8: Wiring diagram for BKS.D.6 BKS\_309.ai

# 5 Operation

## 5.1 Operating Panel

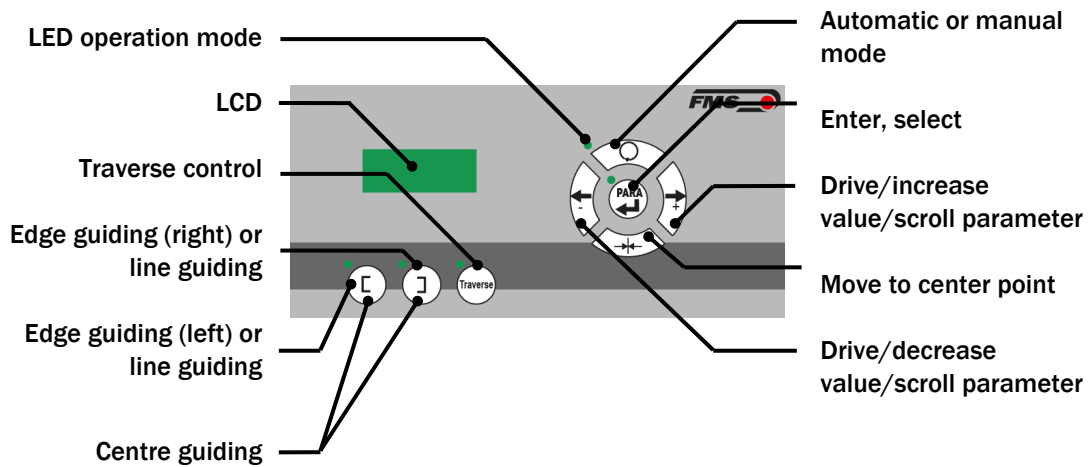

Illustration 9: Operating panel

BKS\_309.ai

## 5.2 Display

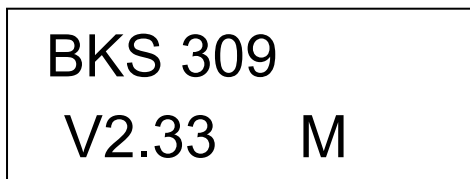

Illustration 10: Start-up display: upper line with product type, lower line with firmware version

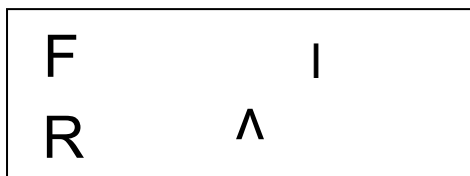

Illustration 11: Standard display during operation, upper line with feedback of the actual position, lower line with reference value

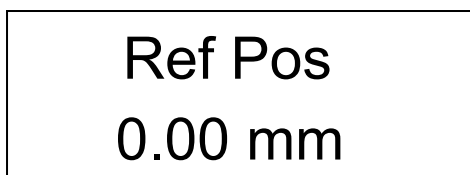

Illustration 12: Menu level, upper line shows selected parameter, lower line shows parameter value

### 5.3 Menu levels

The functions and parameters of the controller are arranged in three different menus.

Menu 1 – system parameters

Menu 2 – operating parameters

Menu 3 – traverse parameters and functions

A complete list of all parameters is printed on page 23.



Key	Function
	<p><b>Manual and Automatic Mode</b></p> <p>To be able to select the different menus for parametrization, you have to enable the manual mode. The LED has to be off.</p>
	<p><b>System Parameters</b></p> <p>If you simultaneously press both keys and hold them for more than 3 sec., the menu for the system parameters will open. The LED is on and the first parameter is shown in the display.</p> <p>Press "Para" again briefly and you will enable the selected parameter. The parameter name starts flashing. This indicates that you can now change the value of the parameter. You can save the changes by pressing the "Para" Button again.</p> <p>If you press and hold the "Para" button for longer than 3 sec. you will leave the menu and return to manual mode.</p>
	<p><b>Operating Parameters</b></p> <p>If you press and hold the key for more than 3 sec., the menu for the operating parameters will open. The LED is on and the first parameter is shown in the display. Press "Para" again briefly and you will enable the selected parameter. The parameter name starts flashing. This indicates that you can now change the value of the parameter. You can save the changes by pressing the "Para" Button again.</p> <p>If you press and hold the "Para" button for longer than 3 sec. you will leave the menu and return to manual mode.</p>
	<p><b>Traverse Parameters and Functions</b></p> <p>If you press the key the menu for the traverse parameters and functions will open. The LED is on and the first parameter/function is shown in the display.</p> <p>Press "Para" briefly and you will enable the selected parameter or start the function. The parameter name starts flashing. This indicates that you can now change the value of the parameter. You can save the changes by pressing the "Para" Button again.</p> <p>If you press the button briefly again you will leave the menu and return to manual mode.</p>

Table 1: Access to the menus

## 5.4 Initial start-up and basic settings



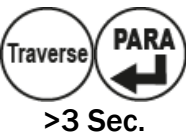



After applying the correct power (24VDC) the system is in operation. Before putting the system into operation, you have to set some basic parameters.

Please clarify the following points:

- **Steering frame / actuator**
  - Steering frames of the FMS webMASTER and webDIRECTOR series are detected automatically
  - Actuators of the FMS winderGLIDE series have to be configured manually. You have to enter the mounting position of the actuator.
- Quantity and type of the applied motorized traverses
- Desired type of control (edge, center, line guiding)
- Units and language displayed on the LCD
- Requirements for the optional relays outputs or digital inputs if you wish to connect the controller to a superordinated control
- Parameters for an optional integration into your network

After the initial start-up the controller is automatically set to manual mode.

### Set language – operating parameter







Key	Function
 > 3 Sec	Enter the menu for changing the operating parameters
	Scroll through the list of parameters to the menu point [Sprache] or [Language]
	Changing the parameter: the selected parameter name starts flashing. This means that you can now change the value of the parameter.
	Change the parameter value as desired
	Confirm the changes: The selected parameter name stops flashing.
 > 3 Sec	Leave the menu for changing the operating parameters. The LED above the key is now off.

To set the other basic parameters proceed as described above:

- Contrast of LCD [Contrast]
- Mounting side of motorized traverse [Traverse]
- Type of motorized traverse [TvTyp R] and [TvTyp L]







If you have installed an actuator of the FMS winderGLIDE series, you have to set the below parameter as well:

### WinderGLIDE – system parameter

Key	Function
 > 3 Sec	Enter the menu for changing the system parameters
	Scroll through the list of parameters to the menu point [WinderGL]
	Changing the parameter: the selected parameter name starts flashing. This means that you can now change the value of the parameter.
	Select the desired type
	Confirm the changes: The selected parameter name stops flashing.
 > 3 Sec	Leave the menu for changing the system parameters. The LED above the key is now off.





### Mounting side of the actuator – operating parameter

This value indicates the position of the actuator in regards of the rolling direction of the web.

Key	Function
 > 3 Sec	Enter the menu for changing the operating parameters
	Scroll through the list of parameters to the menu point [Actuator]
	Changing the parameter: the selected parameter name starts flashing. This means that you can now change the value of the parameter.
	Select the mounting side of the actuator
	Confirm the changes: The selected parameter name stops flashing.
 > 3 Sec	Leave the menu for changing the operating parameters. The LED above the key is now off.

### Start the reference run of the traverse

To initialize the drives of the traverses the exact position of the sensors on the rail has to be set.

Key	Function
	With the controller being in manual mode, enter the menu for changing the traverse parameters. The LED above the key will be on and the first parameter is shown in the display.
	Scroll through the list of parameters to the menu point [RefRun]
	Confirming the selection will instantly start the reference run.
	Leave the menu for changing the traverse parameters. The LED above the key is now off.

The system is now configured and ready for operation.

## 6 Basic functions of the controller

### 6.1 Automatic mode







In the automatic mode the controller leads the web along the reference value and keeps it there.

#### Edge guiding (left or right side)

Reference value (on the LCD " $\wedge$ ") = center of sensor range

#### Center guiding (2 sensors installed)

Reference value (on the LCD " $\wedge$ ") = center position of the 2 sensor axis

Key	Function
	Switch from automatic and manual mode with this key. The LED is on as the controller is set to automatic mode.
	With the controller operating automatically, you can adjust the reference value in steps of 0.1 mm. This will re-adjust the position of the web. "-" means that the web moves in direction of the sensor. "+" means a movement of the web in the opposite direction. If the system is set to center guiding this information refers to the sensor on the left hand side. The shift of the reference value is indicated with " $\wedge$ " on the display. The entire "stroke" that you may use here is $\pm 5$ mm.
	The LED will be on if you activate the traverse function while the system is in automatic mode.  enables you to move the web sideways.  The entire stroke of the traverse can be used. If you have installed 2 sensors, but only 1 traverse it can happen that the sensor that sits on the traverse may collide with the web.
	With activated traverse function in automatic mode you are able to adjust the web position by moving the traverse with the sensor(s).  "- " means a shift of the web to the left "+ " means a shift of the web to the right  There's a high risk of a collision between web and sensors or machine components if you use this kind of control.
	If you utilize two traverses and sensors in center guiding, both sensors will be moved parallel. The menu will offer you a selection. By selecting "SensR/l" you can choose the right sensor as the leading reference. By selecting "SensL/r" the left sensor will be leading the movement. When you confirm the selection with  the display will show the distance to the "home position" of the selected traverse. The sensor on the other side will follow parallel with equal distance.





Leave the menu for changing the traverse parameters. The LED above the key is now off.



The LED is off as you leave the automatic mode.



### Note

**If the web is not moving the system may not be able to lead the web to the reference value! The actuator possibly reaches its limit stops and may cause damage to the web. Only switch to automatic mode when the web is moving slowly.**

## 6.2 Manual mode

The following function are enabled in manual mode

Key	Function
+ >3 Sec	Enter the menu for changing the system parameters. The LED  is on.
 > 3 Sec	Enter the menu for changing the operating parameters. The LED is on.
	Enter the menu for changing the traverse parameters. The LED is on.
	The actuator approaches the stored center position.
	Moving the actuator in 0.1 mm steps to the desired direction. Holding the key will increase the speed of the movement.
	Selection of the guiding logics. The system guides along the left edge or line. The LED indicates "edgle left"
	Selection of the guiding logics. The system guides along the right edge or line. The LED indicates "edgle right"
+	By pressing both keys you will enable the center guiding mode. The system will follow along the theoretical center line of the both sensor positions. The guiding logic is dependent on the applied number of sensors. You can select the center guiding mode only if you have installed 2 sensors. One for each side of the web.

## 6.3 Changing and storing positions of the actuator

You can adjust the home, middle and maximum position of the actuator. These values are stored as operating parameters [Home Pos], [CentrPos] and [Max Pos]. You can either changes these parameter directly via the operating parameter menu or alternatively move the actuator to the desired position in manual mode and store the approached position.

Key	Function
	Press both keys. The LED  is on. The LCD indicates the actual position of the actuator.
	Approach the desired position.
	After pressing briefly the LED starts flashing. The position can now be stored.
	Stores the actual position as [Home Pos]
	Stores the actual position as [Max Pos]
	Stores the actual position as [CentrPos]
	If the operation was successful, the controller will confirm with "Safe Pos done" in the display.
	If the "Safe Pos failed" is shown in the display the position has not been stored. This message indicates that the different position do not correspond to each other. This may happen if e.g. the value for the desired home position exceeds the value for the center position. The positions always have to be in line. [Home Pos] is the smallest value, [Max Pos] is the highest value and the value for [CentrPos] has to be some in between.

## 6.4 Selection of the guiding logics

You can choose from 3 different guiding logics. The selected logic and the configuration of the installed traverses influence the functions of the traverses.





Selected logic	Installed traverse(s)	Reference run of traverse		Edge detect		Retract from web	
		left	right	left	right	left	right
left	left	X		X		X	
left	right		X				X
left	left & right	X	X	X		X	X
right	left	X				X	
right	right		X		X		X
right	left & right	X	X		X	X	X
center	left	X		X		X	
center	right		X		X		X
center	left & right	X	X	X	X	X	X

Table 2: Guiding logics

## 7 Basic functions of the motorized traverse in manual mode

### 7.1 Retract the sensors [Retract]

Select this function to move the sensors away from the web.

Key	Function
	Switch to manual mode. The LED is off
	Enter the menu for changing the traverse parameters. The LED is on.
	Scroll through the list of parameters to the menu point [Retract]
	Confirming the selection will instantly start the function. The sensor moves away for the web to outer position of the traverse.
	Leave the menu for changing the traverse parameters. The LED above the key is now off.

### 7.2 Automatically detect the web edge [Detect]

The traverses move in direction of the web. The sensor signal is permanently monitored. The movement will stop as soon as the web reaches the center of the sensor area. To start this function please, follow the instructions similar to "Retract the sensors".

### 7.3 Approaching the home position as reference [RefRun]

To initialize the drives of the traverses the exact position of the sensors on the rail has to be set. The reference run provides this function. The traverses are completely retracted. If they already are on this position they will travel inwards a short range and return to the home position. To start this function please, follow the instructions similar to "Retract the sensors".

### 7.4 Set an absolute zero point [SetZerPR] [SetZerPL]

With the setup of this zero point you will be able to use the values of the sensor position as absolute dimension. This will be of advantage if you have installed 2 traverses or during the setup procedure your machine.

You can choose each point along the axis of your traverse as a zero point. Pay attention to the following restrictions.

- Max. offset  $\pm 2000$  mm
- If you have installed 2 traverses both of them have to have the identical zero point. Therefore you have to make a one-time measurement of the sensor positions and the traverses.

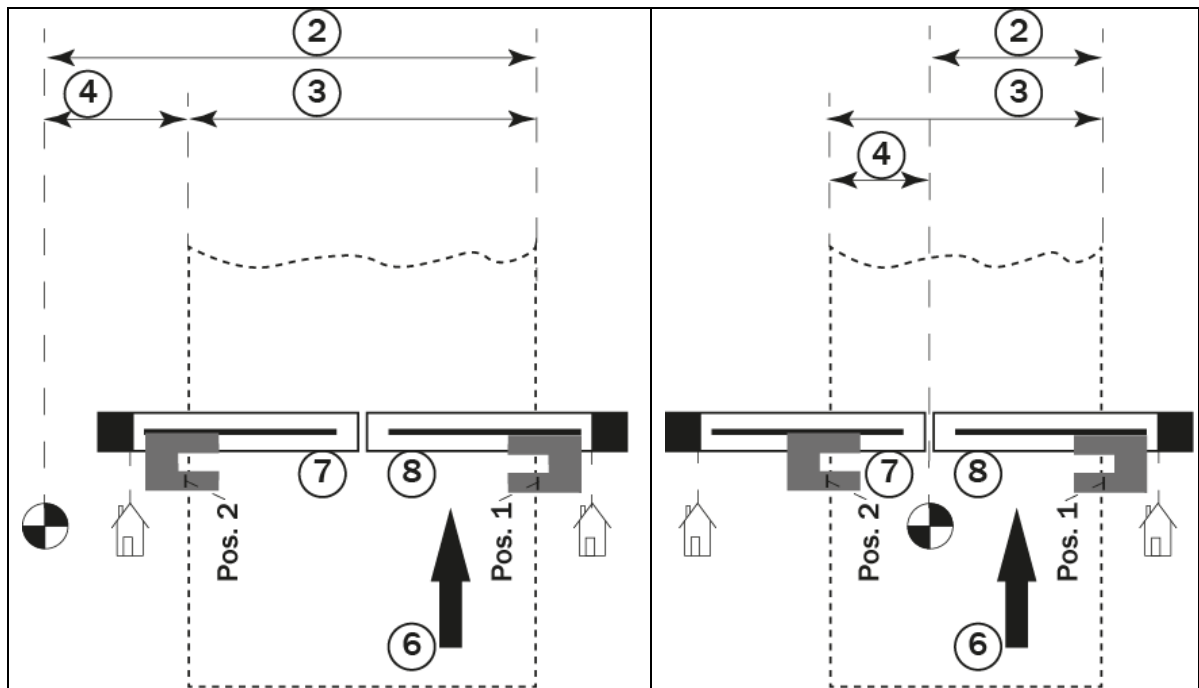

Illustration 13: Zero point set outside the web, e.g. on the machine frame

Illustration 14: Zero point set in the center of the web, in between the traverses.

	Absolute zero point	6	Web and direction of travel
	Home position of each traverse	7	Left traverse, sensor left
2	"Sens R/l" - moving both sensors at the same time. The value indicates the position of the right sensor	8	Right traverse, sensor right
3	Sens L→ - distance of the sensors during movement	Pos. 1	Save Pos - current position sensor 1
4	Sens L/r - moving both sensors at the same time. The value indicates the position of the left sensor	Pos. 2	Save Pos - current position sensor 2

### How to setup the zero point

- Mark the desired spot for the zero point e.g. on the machine frame, etc. clearly with tape, scribe, etc.
- Measure the distances from the zero point to the sensors and note these values. Use the marks on the sensor indicating the center of the sensor area to get distinct values or mark the sensor yourself.
- Enter the values in the menu for changing the traverse parameters.
- As soon as you entered the values, the sensor positions will be refereeing to the zero point.

**Key      Function**

	Switch to manual mode. The LED is off
	Enter the menu for changing the traverse parameters. The LED is on.
	Scroll through the list of parameters to the menu point [SetZerPL] for left sensor or [SetZerPR] for right sensor
	After pressing briefly the LED starts flashing. The display indicates "R→Zr" or "R→Zr" in combination with the value for the current position.
	Enter the distance from the right sensor to the zero point or the left sensor to the zero point respectively.
	Confirming the selection will store the value.
	Leave the menu for changing the traverse parameters. The LED above the key is now off.

### Home Position

This is the mechanical stop at the drive end of an individual traverse. This point is approached during the reference run of the traverse to initialize the sensor position after a first start-up. If you do not establish a zero point all displayed dimensions refer to the home position of each traverse.

### Position point

This is an individual point for each traverse that you can approach, adjust and store in the controller. This point can be of help if you have to deal with frequent changes web widths. After setting up the machine to a certain web width you can store the current sensor positions. When you have re-adjusted the sensor positions for a different web and like to change the original one, you can recall the stored position in seconds.

## 7.5 Repositioning the traverses manually

You can position the sensors manually by moving the traverses. The sensors signals are not monitored during the movement. This bears potential collisions with the web.

As soon as the traverse reaches the mechanic stop the movement is stopped automatically.

Key	Function
	Switch to manual mode. The LED is off
	Enter the menu for changing the traverse parameters. The LED is on.
<b>Re-positioning a single sensor – Reference to zero point</b>	
	Scroll through the list of parameters to the menu point [Sens L] for left sensor or [Sens R] for right sensor.
	After pressing briefly the LED starts flashing. The display indicates "PosR" or "PosL" in combination with the value for the current position in reference to the zero point. If you have not set a zero point the indicated value refers to the home position of the respective sensor.



Drive the sensor to the desired position.



Confirming the selection will store the value

**Re-positioning a single sensor – Reference to other sensor**



Scroll through the list of parameters to the menu point [Sens L→] for left sensor or [Sens R→] for right sensor.



After pressing briefly the LED starts flashing. The display indicates "PosR→" or "PosL→" in combination with the value for the distance to the other sensor.



Drive the sensor to the desired position.



Confirming the selection will store the value

**Parallel re-positioning both sensors – Reference to zero point**

Scroll through the list of parameters to the menu point [Sens R/l] or [Sens L/r]. This function will move both traverses at the same time.



The display will indicate the position of the sensor in capital letters in reference to the zero point. [Sens R/l] means that the distance of the right sensor to the zero point is indicated.

If you have not set a zero point the indicated value refers to the home position of the respective sensor.



Confirming the selection will store the value

## 8 Operating parameters

### Adjusting the offset [Ref Pos]

<b>Description:</b>	the is stored as long the controller is connected to the power supply.		
<b>Range:</b>	-5.00 to	+5.00	<b>Default:</b> 0.00
<b>Increment</b>	0.01		<b>unit:</b> [mm]

### Origin of the reference value [Ref Mode]

<b>Description:</b>	This parameter allows you to define the origin of the reference value when you switch to the automatic mode.
<b>Setting:</b>	<b>[Manual]</b>
<b>Description:</b>	This setting will take the reference value from the parameter [Ref Mode] (default).
<b>Setting:</b>	<b>Automatic [Auto]</b>
<b>Description:</b>	this setting will take the current position of the web (in the sensor area) as reference value.
<b>Note:</b>	<b>The two parameters [RefMode] and [SafeRef] are conditionally dependent on each other. If you require one of both functions, either set [RefMode] to [Auto] or [SafeRef] to [Yes] . Do not activate both functions simultaneously!</b>

### Storing changes of the reference value [SafeRef]

<b>Description:</b>	This parameter stores changes of the reference value and restores them after a restart of the system or sets it to zero.
<b>Setting:</b>	<b>[No]</b>
<b>Description:</b>	Sets the reference value to zero after a restart of the system. (Default)
<b>Setting:</b>	<b>[Yes]</b>
<b>Description:</b>	Sets the reference value to the last stored value after a restart of the system.
<b>Note:</b>	<b>The two parameters [RefMode] and [SafeRef] are conditionally dependent on each other. If you require one of both functions, either set [RefMode] to [Auto] or [SafeRef] to [Yes] . Do not activate both functions simultaneously!</b>

### Tolerance range without influence on control [Deadband]

<b>Description:</b>	Control is activated as soon as the deviation between reference value and actual value increases the value of this parameter. A value of 0.3 mm makes a dead band of $\pm 0.3$ mm without any reaction of the control.		
<b>Range:</b>	0.0 to	2.0	<b>Default:</b> 0.1
<b>Increment</b>	0.1		<b>unit:</b> [mm]

### Set relay outputs 1 and 2 [Relay 1] und [Relay 2]

<b>Description:</b>	This parameter sets the function behind the relay outputs.
<b>Setting:</b>	<b>Middle position found [MidSenso]</b>
<b>Description:</b>	the relay is activated as soon as the web edge is detected in center the sensor area. (Default Relay 1)
<b>Setting:</b>	<b>Web detected [MatFound]</b>
<b>Description:</b>	They relay is activated as soon as the web edge is detected in the sensor area. (Default Relay 2)
<b>Setting:</b>	<b>Automatic mode and web detected [Auto&amp;Mat]</b>
<b>Description:</b>	The relay is activated as soon as the web edge is detected in the sensor area and the controller is set to automatic mode.
<b>Setting:</b>	<b>Automatic mode and no web [Aut&amp;Miss]</b>
<b>Description:</b>	The relay is activated as soon as no web edge is detected in the sensor area and the controller is set to automatic mode.
<b>Setting:</b>	<b>Automatic mode [Auto]</b>
<b>Description:</b>	The relay is activated as soon as the controller is set to automatic mode.
<b>Setting:</b>	<b>Actuator in center position [Centre]</b>
<b>Description:</b>	The relay is activated as soon as the actuator is in center position.
<b>Setting:</b>	<b>[Disabled]</b>
<b>Description:</b>	The relay function is disabled.

### Settings of digital inputs 1, 2, 3 and 4 [Input 1] to [Input 4]

<b>Description:</b>	The controller has 4 digital inputs. These inputs are either level or pulse controlled. The pulse controlled inputs are activated with an impulse of min. 100ms. The level controlled inputs are activated with a rising edge. It stays active as long as the signal is received. The input is deactivated as soon as the signal drops out.
<b>Note:</b>	Any function that you have assigned to an input channel will have a direct impact on the manual operation of the control panel. Level controlled parameters will not be visible in the respective menu and keys will be disable, e.g. when you assign "automatic/manual mode" key to an input, the key on the panel will be disabled.
<b>Setting:</b>	<b>Pulse controlled manual/automatic mode [Edge→Aut]</b>
<b>Description:</b>	The controller switches from manual to automatic mode or vice versa. (Default for Input 1)
<b>Setting:</b>	<b>Level controlled manual/automatic mode [Lv→Auto]</b>



**Description:** The controller switches from manual to automatic mode or vice versa.

**Setting:** **Move actuator to center position [Centre]**

**Description:** This input triggers the movement of the actuator to the center position. (Default for Input 2). This input is level controlled

**Setting:** **Decrease reference value or drive to left [-Ref/ ←]**

**Description:** Depending on the operating mode two settings are possible. If the controller is set to manual mode the steering frame moves to the left side of the installed actuator retracts. If the controller is set to automatic mode the reference value is increased in increments of 0.1 mm. (default for Input 3). This input is pulse controlled.

**Setting:** **Increase reference value or drive to right [+Ref/→]**

**Description:** Depending on the operating mode two settings are possible. If the controller is set to manual mode the steering frame moves to the right side of the installed actuator extends. If the controller is set to automatic mode the reference value is increased in increments of 0.1 mm. (default for Input 4). This input is pulse controlled.

**Setting:** **Lock steering frame [Lock]**

**Description:** the steering frame is locked as soon as the level rises. The Input [Lock], operating mode [Auto] and the parameter [Auto→Man] are partly dependent on each other. The interaction is compiled in the following table.

Dig.inp. Lock	Mode Auto.	Parameter Auto→Man	Function
0	Not active	Center	Move to center position
0	active		Automatic mode
1	Not active	Manual	Stops at current position
1	Not active	Center	Move to center position
1	active	–	Stops at current position

**Setting:** **Reset the reference value [ResetRef]**

**Description:** this function is level controlled and resets the reference value to zero as soon as a positive edge drops in.

**Setting:** **Retract traverses [Retract]**

**Description:** This pulse controlled function retracts all installed traverses.

**Setting:** **Automatic traverse movement to detect web [Detect]**

**Description:** This level controlled function triggers the automatic search for the web. The function is active as long as the input signal is equal to the input voltage. If the level decreases to zero the function is deactivated.

**Setting:** **Reposition traverse [Goto Pos]**

**Description:** A rising edge on the input triggers this function and the stored position point is approached.

**Setting:**

**Description:** This function disables the selected input.

**Setting:**

**Description:** This level controlled function triggers the movement of the connected traverse to the right. The traverse moves as long as the input signal is equal to the input voltage. If the level decreases to zero the movement stops.

If two traverses are installed and configured, both will move to the right in parallel.

**Setting:**

**Description:** This level controlled function triggers the movement of the connected traverse to the left. The traverse moves as long as the input signal is equal to the input voltage. If the level decreases to zero the movement stops.

If two traverses are installed and configured, both will move to the right in parallel.

**DLS**

**Purpose:** If you use a DLS2 sensor, you have to set the correct installation direction. You can only connect one DLS2 sensor.

**The user can choose between three settings.**

**Setting:**

**Purpose:** There is no DLS2 sensor connected. Standard setting.

**Setting:**

**Purpose:** The DLS2 sensor is installed on the left-hand side (in direction of the moving web)

**Setting:**

**Purpose:** The DLS2 sensor is installed on the right-hand side (in direction of the moving web)

**[Password]**

**Description:** You can protect the access to the controller settings with a password. The password cannot be changed and is set to 3231.

**Setting:**

**Description:** Password protection disabled (default)

**Setting:**

**Description:** Password protection enabled.

**[Sprache] [Language]**

**Description:** Choose the desired language on the display.

**Setting:**

**Description:** default

**Setting:**

**LCD-contrast [Contrast]**

**Description:** to achieve the maximum legibility you can change this value depending on the location, illumination, etc.

<b>Range:</b>	1 to 100	<b>Default:</b>	65
<b>Increment:</b>	1	<b>unit:</b>	[%]

**Units on display [Unit sys]**

**Description:** Choose the desired units.

**Setting:**

**Description:** Default

**Setting:**

**Description:** Setting for imperial system.

**Set the gain [Gain]**

**Description:** Use this parameter to set the gain/dynamic of the controller.

<b>Range:</b>	0.02 to 2.00	<b>Default:</b>	0.20
<b>Increment</b>	0.01	<b>unit:</b>	[ - ]

**Speed of actuator [AdjSpeed]**

**Description:** this parameter sets the maximum speed of the actuator.

<b>Range:</b>	1 to 100	<b>Default:</b>	100
<b>Increment</b>	1	<b>unit:</b>	[%]

**Start-up setting [Power ON]**

**Description:** This parameter determines the operating mode after a start-up.

<b>Setting:</b>	<b>[Manual]</b>
<b>Description:</b>	The controller is set to manual mode (default)
<b>Setting:</b>	<b>[Auto]</b>
<b>Description:</b>	The controller is set to automatic mode.
<b>Setting:</b>	<b>[Last Set]</b>
<b>Description:</b>	The controller is set to the mode that was set before the system has been shut down.

**Leaving the automatic mode [Auto→Man]**

<b>Description:</b>	This parameter determines the behavior of the controller when you leave the automatic mode.
<b>Setting:</b>	<b>[Manual]</b>
<b>Description:</b>	The control is determined and the controller switches to manual mode. (Default)
<b>Setting:</b>	<b>[Center]</b>
<b>Description:</b>	The control is determined and the steering frame/actuator moves to the center position. (Default)

**Home position of the actuator [Home Pos]**

<b>Description:</b>	This parameter determines the home position of the actuator in retracted position. This position acts as stop and will never be crossed. Refer to page 17.		
<b>Range:</b>	0.0 to	300.0	<b>Default:</b> 0.0
<b>Increment:</b>	0.1		<b>unit:</b> [ mm]
<b>Requirement:</b>	This parameter is only accessible if an actuator of the FMS winderGLIDE series is installed.		

**Center position of the actuator [CentrPos]**

<b>Description:</b>	This parameter determines the center position of the actuator. If you press  the actuator approaches this position automatically. Refer to page 17.		
<b>Range:</b>	0.0 to	300.0	<b>Default:</b> 62.5 <sup>4)</sup>
<b>Increment:</b>	0.1		<b>unit:</b> [ mm]
<b>Requirement:</b>	<sup>4)</sup> The default setting is depending on the type (stroke) of the installed actuator. This parameter is only accessible if an actuator of the FMS winderGLIDE series is installed.		

### Actuator position in maximum extended position [Max Pos]

<b>Description:</b>	This parameter determines the position of the actuator in the most extended position. This position acts as stop and will never be crossed. Refer to page 17.		
<b>Range:</b>	0.0 to	300.0	<b>Default:</b> 125.0 <sup>4)</sup>
<b>Increment:</b>	0.1		<b>unit:</b> [ mm]
<b>Requirement:</b>	<sup>4)</sup> The default setting is depending on the type (stroke) of the installed actuator. This parameter is only accessible if an actuator of the FMS winderGLIDE series is installed.		

### Alignment of the actuator [Actuator]

<b>Description:</b>	This parameter is important for the control logic and determines the moving directions of the actuator.
<b>Requirement:</b>	This parameter is only accessible if an actuator of the FMS winderGLIDE series is installed.
<b>Setting:</b>	<input type="text" value="[Left]"/>
<b>Description:</b>	The actuator is mounted on the left side of the winding/unwinding station in reference to the moving direction of the web. (Default)
<b>Setting:</b>	<input type="text" value="[Right]"/>
<b>Description:</b>	The actuator is mounted on the left side of the winding/unwinding station in reference to the moving direction of the web.

### Type of traverse [TvTyp L] and [TvTyp R]

<b>Description:</b>	This parameter determines which type of traverse is installed on the left and right side of the web guide system. Parameters for both sides are visible although you have only installed one traverse.
<b>Setting:</b>	<input type="text" value="[TA.200]"/>
<b>Description:</b>	Motorized traverse with a stroke of 200 mm (7.8 in) (Default).
<b>Setting:</b>	<input type="text" value="[TA.400]"/>
<b>Description:</b>	Motorized traverse with a stroke of 400 mm. (15.6 in)
<b>Setting:</b>	<input type="text" value="[TA.600]"/>
<b>Description:</b>	Motorized traverse with a stroke of 600 mm. (23.4 in)
<b>Setting:</b>	<input type="text" value="[TA.1000]"/>
<b>Description:</b>	Motorized traverse with a stroke of 1000 mm. (39 in)

**Direction of positive movement [LegthInc]**

**Description:** This parameter determines the direction to which the displayed value will increase.

**Setting:** [Left]

**Description:** The value increases as the sensor moves to the left.

**Setting:** [Right]

**Description:** The value increases as the sensor moves to the right.

**Alignment of traverses [Traverse]**

**Description:** This parameter determines the quantity and mounting position of the installed traverses. The selected option also influences some functions and the behavior of the control when you switch from manual to automatic mode.

**Setting:** [none]

**Description:** There's no traverse installed. You can also choose this setting if you want to block the function of an installed traverse. The menu for traverse parameters and functions will not be accessible with this selection.

**Setting:** [Left]

**Description:** There is one traverse on the left side installed. Only this traverse will be controllable via the panel. The search run [Detect] will start from left to right if you switch to automatic mode.

**Setting:** [Right]

**Description:** There is one traverse on the right side installed. Only this traverse will be controllable via the panel. The search run [Detect] will start from right to left if you switch to automatic mode.

**Setting:** [L and R]

**Description:** There are two installed traverses on the system. Both are controllable via the panel.

**[IP Addr]**

**Description:** This parameter defines the IP address of the controller. This is the basic requirement to connect it to a network. You have to enter the IP address in 4 separate blocks.

[IP BI 1 to 4]

**Range:** 0 to 255 **Default:** 192.168.0.090

**Increment:** 1 **Unit:** [-]

**[Subnet]**

**Description:** This parameter defines the IP address of the controller. This is the basic requirement for a communication via web browser. You have to enter the subnet mask address in 4 separate blocks.  
(Sub. BI 1 to 4).

**Range:** 0 to 255 **Default:** 255.255.255.0  
**Increment:** 1 **unit:** [ - ]

**[LANSpeed]**

**Description:** This parameter determines the data transfer rate between controller and receiver (data-switch, hub or PC)

**Selection:** 10 or 100 **Default:** 100  
**Increment:** n.a. **Unit:** [MBPS]

**Reset to default settings [Default]**

**Description:** You can reset the controller to the default settings with this parameter.

**Selection:**

**Description:** This selection will not touch your settings.

**Selection:**



**Description:** After confirming this selection the default settings of the controller will be set and a re-start of the system is initiated.

## 9 System parameters



### Warning

**All system parameters have been pre-set individually per system. These settings should only be changed in compliance with the FMS Service. Non-authorized changes can lead to malfunctions and cause damage to the system or the machine.**

To enter the mode for changing the system parameters you have to press the keys  and  at the same time and hold it for 3 sec. The LED above  switches on and the first parameter name is displayed in the LCD.

System parameters are not affected by the reset to default settings.

#### Adjustment of the reference value [Offset><]

**Description:** Choose this value to adjust the reference value of the steering frame/actuator.

**Range:** -5.00 to +5.00 **Default:** 0.00  
**Increment:** 0.01 **unit:** [mm]

#### Type of positioning system [PosDetect]

**Description:** This parameter determines the type of positioning system of the actuator drive. A modification of this parameter requires a re-start of the controller.

**Typ:**

**Description:** A potentiometer is used to detect the traveling limits and the center position of the actuator.  
 If you have installed an actuator of the FMS winderGLIDE series this value is set automatically.

**Typ:**

**Description:** A single hall sensor is used to detect the position of the drive.

**Typ:**

**Description:** Two hall sensors are used to detect the position of the drive.  
 (Default)



**Center position of actuator [CentrPos]**

**Description:** This parameter is only accessible if [PosDetect] is set to one hall sensor. It defines the center of stroke from the fully retracted position of the actuator. This is the reference point for the programmed function behind the key .

**Range:** 0 to 10'000 **Default:** 2000  
**Increment:** 1 **Unit:** [steps]

**Stop on the right side of the steering frame [RightLim]**

**Description:** This parameter is only accessible if [PosDetect] is set to one hall sensor. It limits the stroke to the right side of the steering frame. The position will not be crossed during automatic mode or in manual operation.

**Range:** 0 to 10'000 **Default:** 4000  
**Increment:** 1 **Unit:** [steps]

**Direction of rotation [DriveDir]**

**Description:** This parameter determines the direction of rotation of the actuator. Typically, stepper motors rotate clockwise. If you use different motors you have the possibility to adjust the direction accordingly with this parameter.  
 a) Reverse the polarity of the drive motor.  
 b) Reverse mechanical installation of the drive.

**Setting:**

**Description:** This is the setting to choose if you have installed a standard drive or a steering frame.

**Setting:**

**Description:** Select this setting if you have installed a motor with reverse direction of rotation.  
 If you have installed an actuator of the FMS winderGLIDE series this parameter is automatically set by the controller.

**Type of actuator [WinderGL]**

**Description:** This parameter defines the type of FMS winderGLIDE that you have installed.

**Type:**

**Description:** Maximum stroke of 125mm (4.92in).

**Type:**

**Description:** Maximum stroke of 200mm (7.87in).

**Type:** [D.3.300] or [D.6.300]

**Description:** Maximum stroke of 300mm (11.81in).



### **Warning for BKS.D.4**

*If you are using an FMS winderGLIDE BKS.D.4 you have to select the parameter for the BKS.D.3 with the corresponding stroke of 125 or 200mm.*

## 10 Traverse parameters and functions

### Retract the sensors from the web [Retract]

**Description:** This function will automatically retract all configured traverses. The home position will be approached.

### Automatic web detection [Detect]

**Description:** This function will start to move all configured traverses in direction of the web. Sensor signal is permanently monitored during this process. The detection is stopped as soon as the web is detected in the center of the sensor area. If the web moves during the detection mode the sensors will follow that movement. After 3 min. this function is automatically determined.

### Approach the home position [RefRun]

**Description:** You will need to trigger this function after the initial setup of the system. It is use to initialize the measuring system of the traverses and to set the reference point for the future display of distance values in the LCD.  
As soon as you change the configuration of the installed traverses (qty., stroke, etc.) the system will ask you to trigger this function again.

### Manually moving a single sensor, display of absolute dimensions [Sens L] and [Sens R]

**Description:** This function will move the selected sensor. The display will show the distance from the sensor to the zero point. If you have not set a zero point the indicated value refers to the home position of the sensor. Refer to page 19.

### Manually moving a single sensor, display of relative dimensions [Sens L→] and[Sens R→]

**Description:** This function will move the selected sensor.  
The display will show the distance from one sensor to the other sensor. If you have not set a zero point the indicated value refers to the home position of the selected sensor.

**Requirement:** Two traverses have to be configured and the zero point has to be defined.

### Manually moving two sensors, display of absolute dimensions [Sens L/r] and [Sens R/]

**Description:** This function will move both sensors in parallel.  
The display will show the distance from the sensor "in capital letter" to the zero point. [SensL/r] will show the distance from the left sensor to the zero point.  
If you have not set a zero point the indicated value refers to the home position of the selected sensor.

**Requirement:** Two traverses have to be configured and the zero point has to be defined.

### Safe and approach a point along the traverses [Safe Pos] and [Goto Pos]

**Description:** After you have manually positioned one or both sensors you can store the current positions in the parameter [Safe Pos]. The parameter [Goto Pos] allows you to approach the stored position at any time.



### Set a zero point [SetZerPR] and [SetZerPL]

**Description:** This parameter allows you to define a zero point for the right [SetZerR] and left [SetZerL] sensor. With the setup of this zero point you will be able to use the values of the sensor position as absolute dimension. This will be of advantage if you have installed 2 traverses or during the setup procedure your machine.

**Requirement:** min. one traverse has to be configured and the zero point has to be defined. If you have installed 2 traverses the zero point of both traverses has to be identical. Refer to page 19.

## 11 Restore default settings

You can restore the default settings of the controller with the operating parameter [Default]. Refer to page 23.

Alternatively, you can press simultaneously press  and  during the start-up (apply supply voltage) of the controller. The display will show "Reset to Default".

After a reset you have to trigger the [RefRun] within the menu for the traverse parameters.



**Note**

*The operating parameters [Home Pos], [CentrPos] and [Max Pos] as well as all system and traverse parameters are not affected of a reset.*

## 12 Setup for connection to a PC or network

You can easily configure the controller via web browser (Internet Explorer 7 or higher). Before that you need to connect the controller to a PC or to an Ethernet network.

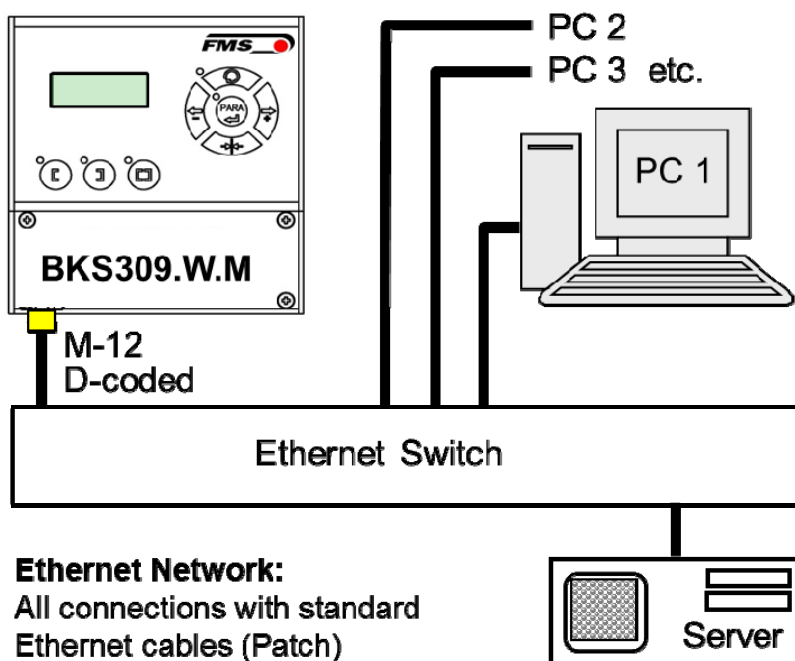

Illustration 15: Configuration in a Local Area Network LAN

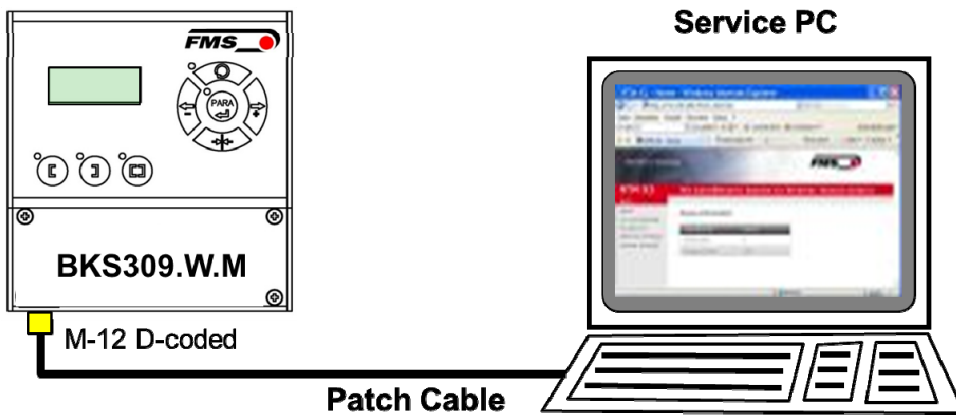

Illustration 16: connection to a PC

## 12.1 Connection via web browser

Make sure that you have assigned an IP address in a static block to your PC. As soon as you integrated the controller into a network you can access it via its default address. Just enter `http://192.168.0.90` into the address line of your browser. The following screen will open.



Illustration 17: Serial number and system information

The navigation is located on the left side of the screen.

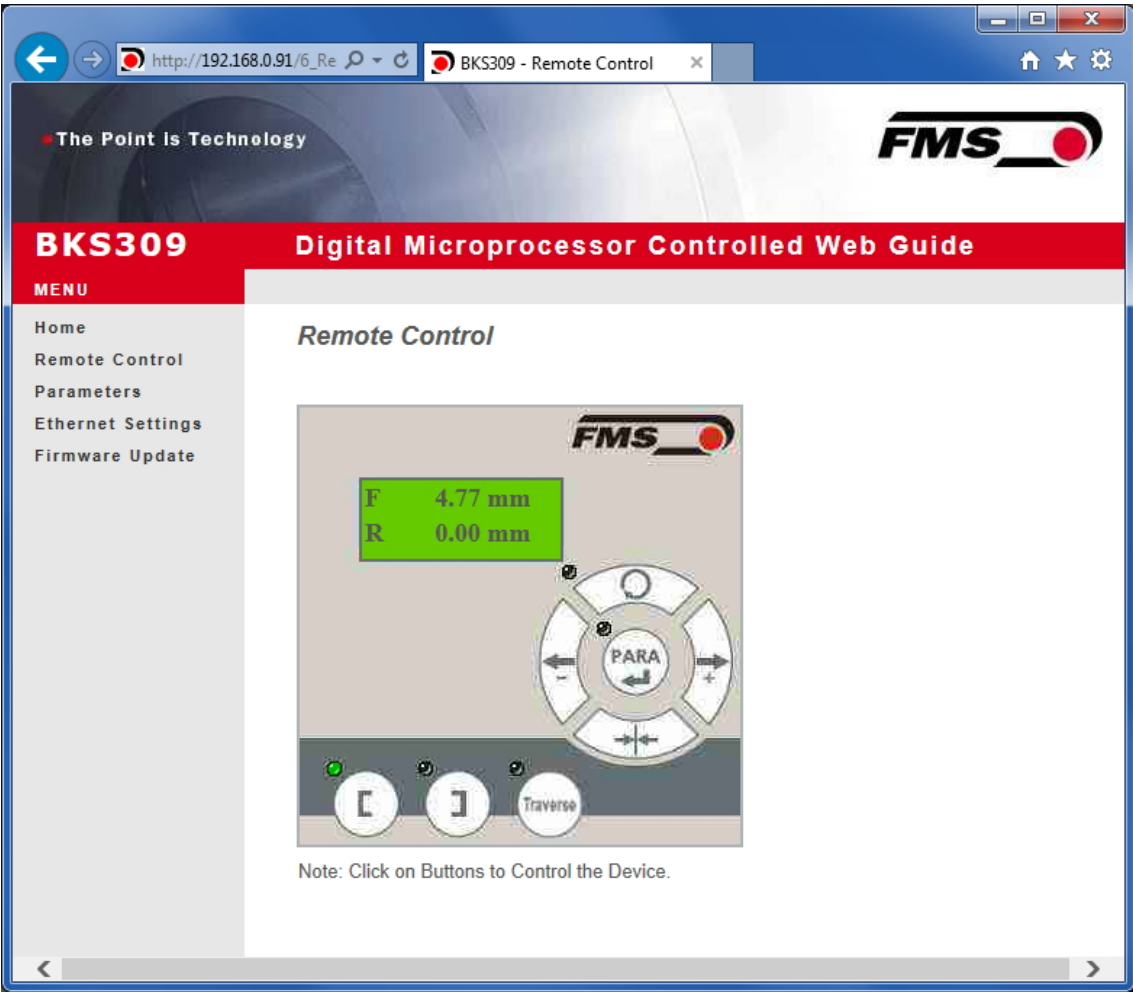

Illustration 18: Virtual operating panel

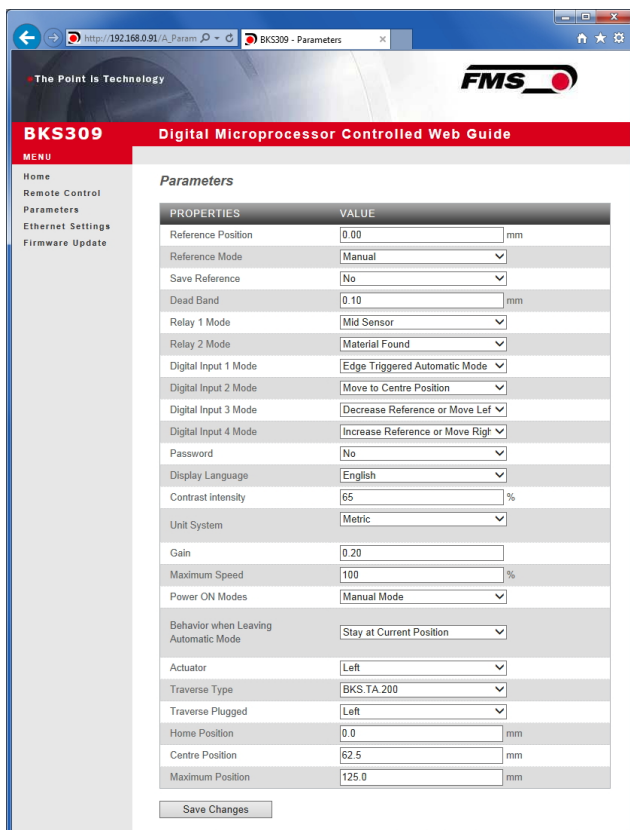

Illustration 19: List of parameters

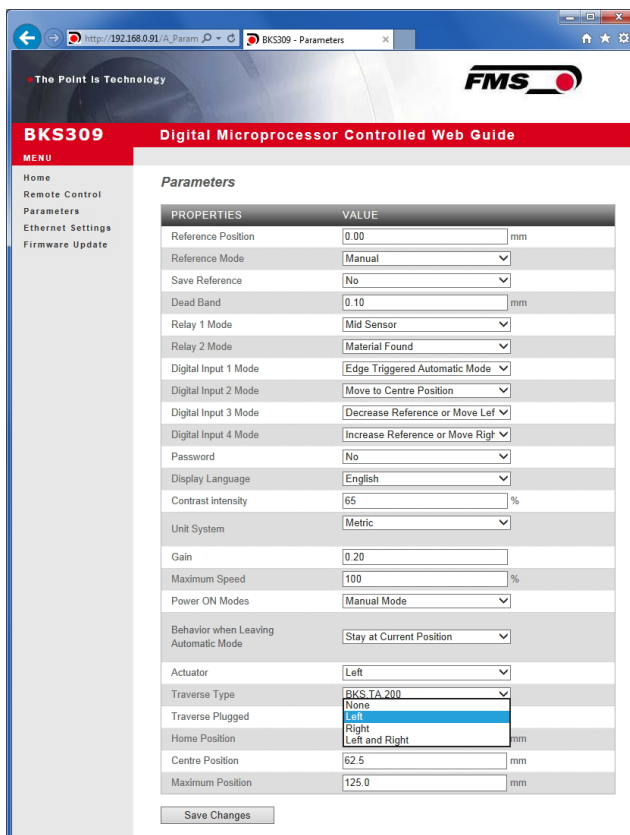

Illustration 20: Traverse settings

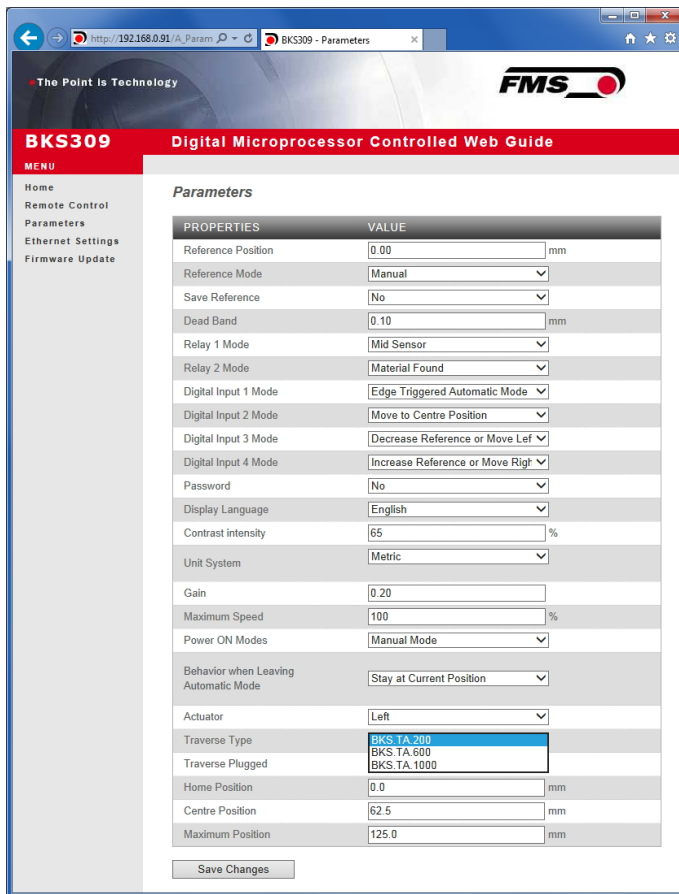

Illustration 21: Traverse types

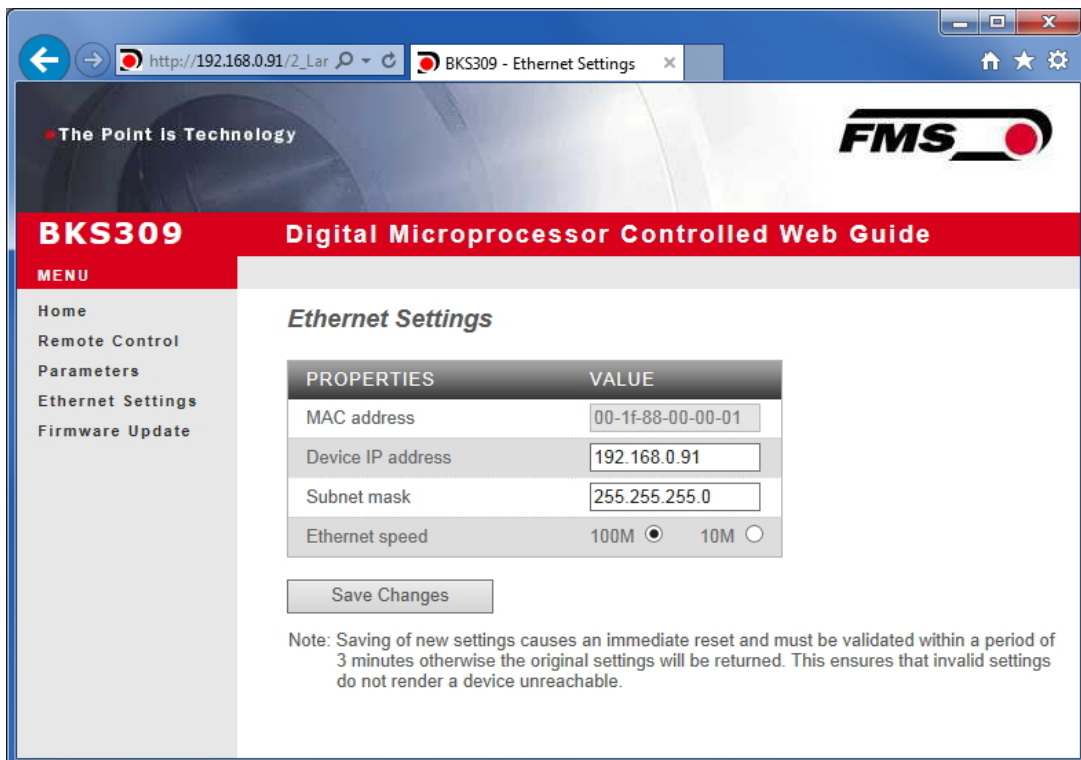

Illustration 22: Ethernet settings



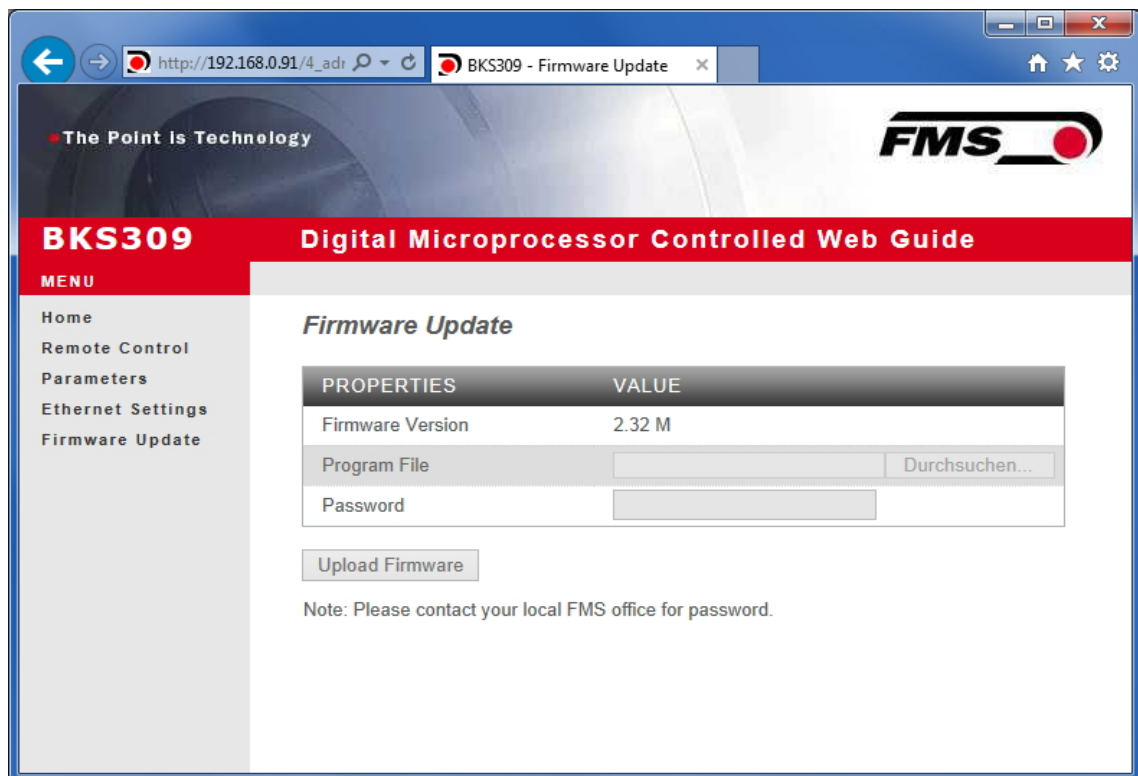

Illustration 23: Firmware version

## 12.2 Setting up a peer-to-peer connection with a PC

Make sure that you have assigned an IP address in a static block to your PC. If you have already connected the controller to a network you can skip the following steps.

The following settings are valid for MS Windows 7:

1. Connect PC and controller with a patch-cable
2. Start-up controller and PC
3. Press "Start" on the lower left corner on the PC screen
4. Press "system control"
5. Double-click on LAN connection

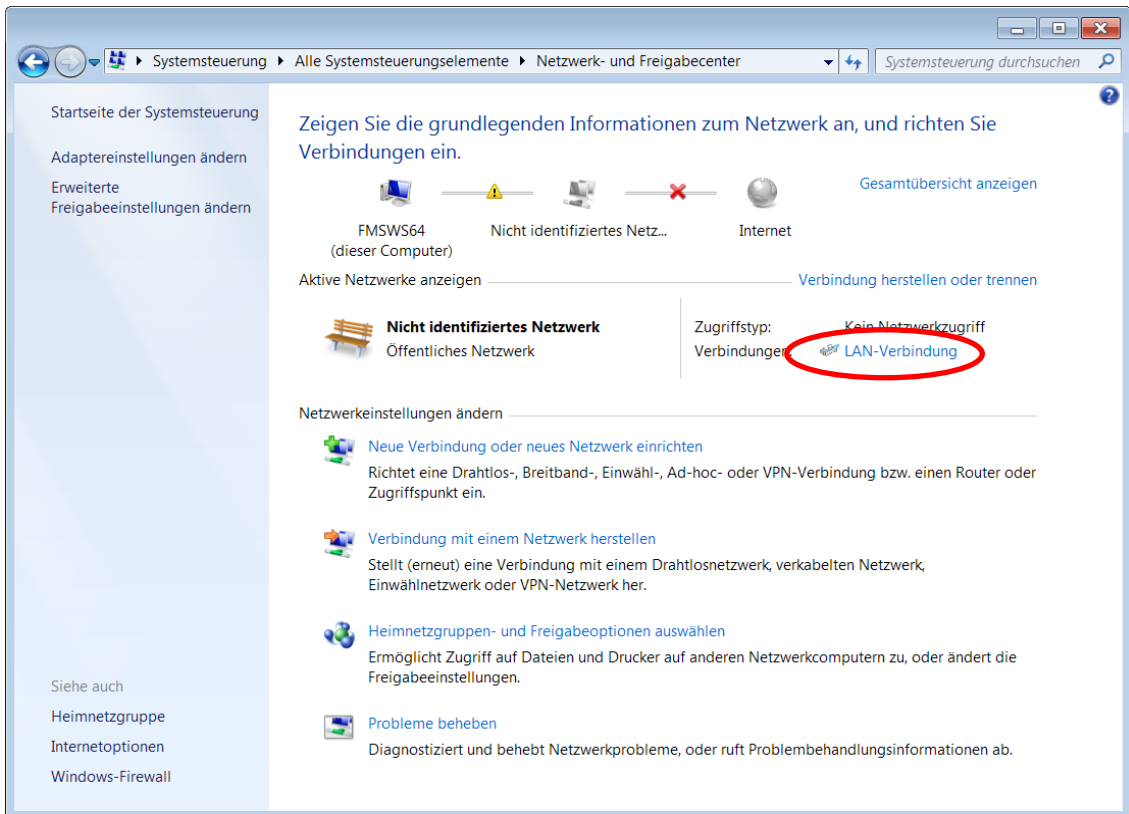

Illustration 24: Status of the LAN connection

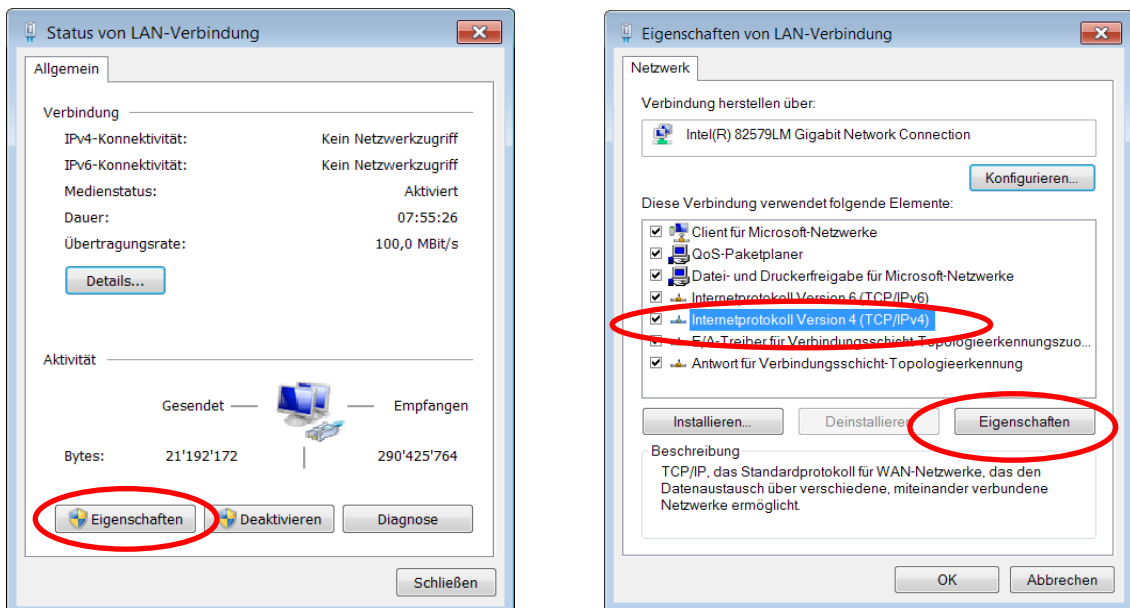

Illustration 25: Status of the LAN connection

6. Select "Properties"
7. Window "properties of LAN connection" will open.
8. Select "Internet protocol Version 4 (TCP/IPV4) ".
9. Click on "properties"
10. The following window will open

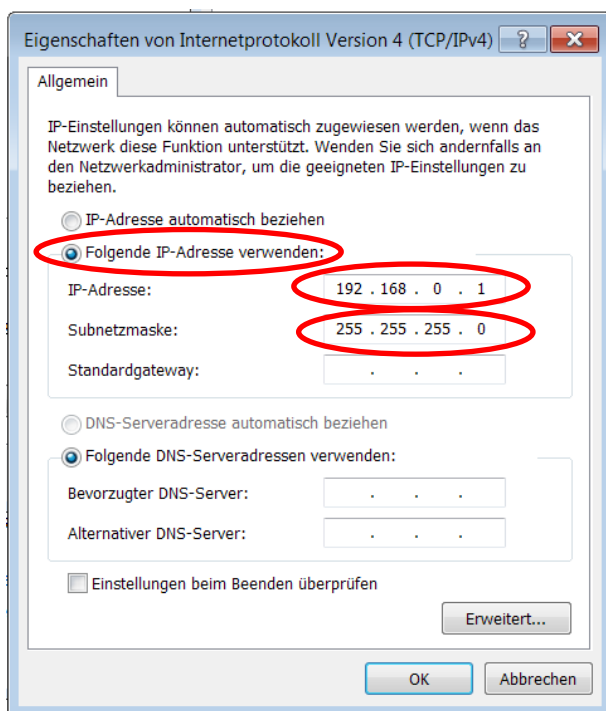

Illustration 26: Properties internet protocol

11. Select "use the following IP address"
12. Enter the address of your PC (e.g. 192.168.000.1)
13. Enter 255 255 255 000 into the subnet mask
14. Press "ok" to close the window and return to the main screen by closing all other dialog boxes.

Your computer is now ready for the communication with the controller.

1. Start your web browser. (Microsoft Internet Explorer, Mozilla Firefox, etc.)
2. The default IP address of the controller is set to 192.168.000.090. Enter this address into the search field of your browser and press enter.  
Enter the address in the following format: **192.168.0.90**.
3. The screen "BKS309.W.M-Home" will open. Refer to page XXX.

# 13 Trouble-shooting

Error	Cause	Solution
<b>Web edge outside sensor detection area</b>	The edge has moved outside the sensor detection area.  Too big adjustment of the reference value	Re-adjust the sensor to the edge. Check adjustment of the reference value
<b>Actuator travels to "the wrong side" or guides the web edge out of the sensor range.</b>	Sensor on the wrong side	Install the sensor on correct side
	Sensor is connected on the wrong terminal	Connect to correct terminal
	Wrong moving direction of the actuator	Re-adjust system parameter [DriveDir] Change poles on drive motor
<b>Actuator does not move</b>	No sensor signal	Check wiring, installation in terminal
		Check cable for defects
		Send sensor to FMS
	Power supply not connected	Check supply, wiring, voltage
	Overvoltage protection activated	Send controller to FMS
	Defective PC board	Send controller to FMS
	Inface wiring not correct	Check wiring and connectors
<b>No Ethernet connection</b>	Defective actuator on steering frame	Replace actuator, contact FMS
<b>Functions are not displayed in the menu</b>	Functions have been set to be triggered via digital inputs	Check operating parameters [Input 1 to4]
<b>manual/automatic mode key does not work</b>	Function has been set to be triggered via digital input	Check operating parameters [Input 1 to4]

Error	Cause	Solution
<b>Display and menu does only offer the selection of one traverse/sensor, but 2 are connected</b>	Wrong configuration of traverses	Adjust operating parameter [Traverse]

# 14 Dimensions

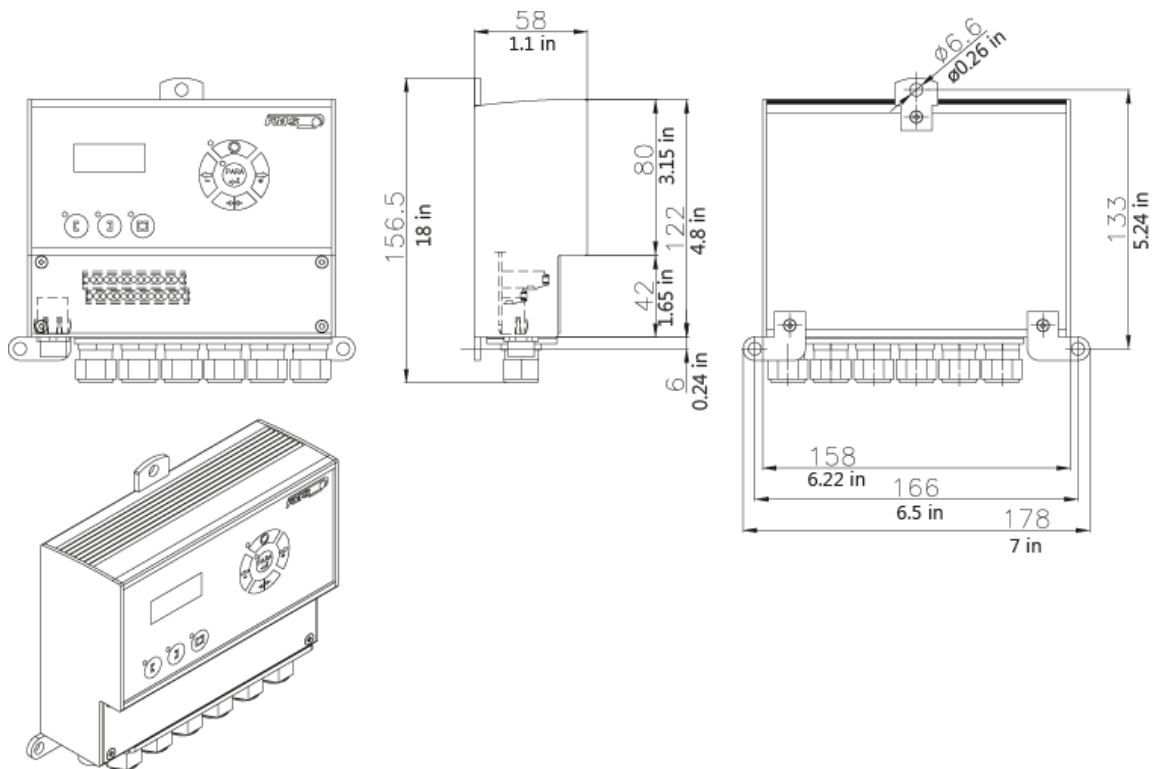

Illustration 27: Dimensions of the housing in mm and in.

# 15 Technical Data

Cycle time processor	1 ms
Drive	Stepper motor, threaded spindle
Analog inputs	2 inputs 0...10 V (for sensors)
Digital inputs	4 inputs, 24 VDC electrically isolated
Relay outputs	2 outputs. DC: 220 V/2 A/60 W; AC: 250 V/62.3 VA
Power supply	18...30 VDC ( $V_{nom} = 24$ VDC)
Temperature range	-10 to 60 °C (14 to 140 °F)
Protection class	IP65





**FMS Force Measuring  
Systems AG**  
Aspstrasse 6  
8154 Oberglatt (Switzerland)  
Tel. 0041 1 852 80 80  
Fax 0041 1 850 60 06  
info@fms-technology.com  
www.fms-technology.com

**FMS USA, Inc.**  
2155 Stonington Avenue  
Suite 119  
Hoffman Estates,, IL 60169  
(USA)  
Tel. +1 847 519 4400  
Fax +1 847 519 4401  
fmsusa@fms-  
technology.com

**FMS (UK)**  
Aspstrasse 6  
8154 Oberglatt  
(Switzerland)  
Tel. +44 (0)1767 221 303  
fmsuk@fms-technology.com

**FMS (Italy)**  
Aspstrasse 6  
8154 Oberglatt (Switzerland)  
Tel. +39 02 39487035  
fmsit@fms-technology.com