



Operating Instructions

EMGZ491.EIP

Single-channel measuring amplifier for ETHERNET/IP

EMGZ491.R.EIP for mounting on DIN rail

EMGZ491.W.EIP for wall mounting

Document Version	2.6	01/2024 NS
Firmware Version	V 2.0.4	
EDS Datei	FMS_TensionAmpilfier_EMGZ491_EIP_V2_1.eds	



EtherNet/IP®

Diese Bedienungsanleitung ist auch in Deutsch erhältlich.

Bitte kontaktieren Sie Ihre lokale FMS Vertretung.

1 Table of Contents

1	TABLE OF CONTENTS	2
2	SAFETY INFORMATION	4
2.1	Presentation of Safety Information.....	4
2.1.1	Danger that Could Result in Minor or Moderate Injuries	4
2.1.2	Note Regarding Proper Function	4
2.2	General Safety Information	5
3	PRODUCT DESCRIPTION	6
3.1	Block Diagram.....	6
3.2	System Description	6
3.3	Scope of Delivery	6
4	QUICK GUIDE/QUICK START	7
4.1	Preparations for Parameterization	7
4.2	Mounting Sequence	7
4.3	Mounting and Electrical Connections.....	7
4.4	Force sensor Mounting	8
4.5	Electrical Connections.....	8
4.5.1	EMGZ491.R.EIP	8
4.5.2	EMGZ491.W.EIP	9
4.5.3	Ethernet Connections	10
5	CALIBRATION OF THE MEASURING SYSTEM.....	11
5.1	Offset Compensation	11
5.2	Calibration (Adjusting the Gain Factor).....	11
5.3	Calibrating	12
5.4	Gain.....	12
5.5	Limit Value Violations.....	13
5.5.1	Overload Test	13
5.5.2	Overflow and Underflow Test	14
5.6	Description of the LEDs	14
6	INTEGRATION INTO THE ETHERNET/IP NETWORK.....	15
6.1	EtherNet/IP Interface.....	15
6.2	TCP/IP Configuration	15
6.3	Data Exchange.....	15
7	CONFIGURATION.....	16
7.1	Modify IP address with RSLinx	16
7.2	Parameter Description	18
7.3	Cyclic Data Traffic	21
7.4	Acyclic Data Traffic	23
8	ETHERNET/IP COMMUNICATION.....	27
8.1	General Function.....	27
8.2	Services and Protocols	27
9	WEB INTERFACE.....	28
9.1	Peer-to-Peer connection with laptop.....	28
9.2	Assign static IP-address to laptop.....	28
9.3	Connect device with laptop	31
9.4	Web interface	32
9.5	Ethernet Device Configuration Tool	36



10 DIMENSIONS 40

11 TECHNICAL DATA 41

2 Safety Information

All safety information, operating and installation regulations listed here ensure proper function of the device. Safe operation of the systems requires compliance at all times. Noncompliance with the safety information or using the device outside of the specified performance data can endanger the safety and health of persons.

Work with respect to operation, maintenance, retrofit, repair, or setting the device described here must only be performed by expert personnel.

2.1 Presentation of Safety Information

2.1.1 Danger that Could Result in Minor or Moderate Injuries



Danger, warning, caution

Type of danger and its source

Possible consequences of nonobservance

Measure for danger prevention

2.1.2 Note Regarding Proper Function



Note

Note regarding proper operation

Simplification of operation

Ensuring function

2.2 General Safety Information



The function of the measuring amplifier is only ensured with the components in the specified layout to one another. Otherwise, severe malfunctions may occur. Thus, observe the mounting information on the following pages.



Observe the local installation regulations.



Improper handling of the electronics module can lead to damage to the sensitive electronics!

Do not work with a blunt tool (screw driver, pliers, etc.) on the housing!

Use suitable grounding (grounding wrist strap, etc.) when working on the electronics.



The devices should have a distance of at least 15 mm to one another in the control cabinet for proper cooling.

3 Product Description

3.1 Block Diagram

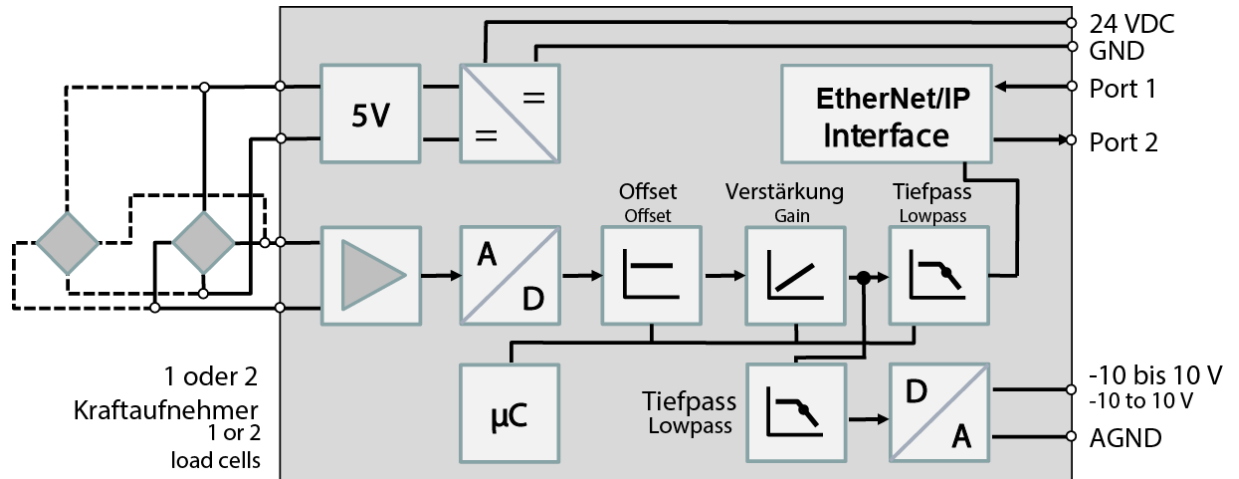

Figure 1: EMGZ491.EIP block diagram

3.2 System Description

The microprocessor-controlled measuring amplifier EMGZ491.EIP series is used in processing, amplifying, and relaying sensor signals in suitable form to downstream devices. The measured force values are available via ETHERNET/IP and an analog voltage output.

The measuring amplifiers are suitable for tension measurements using all FMS force sensors. 1 or 2 sensors can be connected to the device. Furthermore, device information, parameters, and system settings can be accessed via a web browser. Offset compensation and system calibration can also be performed via the web browser.

3.3 Scope of Delivery

The following is included in the scope of delivery

- Measuring amplifier
- Mounting and operating instructions

The following is not included in the scope of delivery

- AC/DC power supply, minimum requirement: EMC immunity specifications EN61000-4-2, 3, 4, 5; EN55024 light industry level, criteria A, e.g., TRAKO TXL 035-0524D
- Cable for power supply

The following is not included in the scope of delivery, but are available as accessories from FMS

- Patch cable with RJ45 plug (straight or 90°)
- Sensor cable for the connection of force sensor and measuring amplifier
- M12 plug, D-coded

4 Quick Guide/Quick Start

In these operating instructions, commissioning of the EMGZ491.EIP amplifier is limited to the installation procedure, offset compensation, and system calibration.

4.1 Preparations for Parameterization

- Read the operating instructions of the selected force sensor carefully.
- Check your requirements on the system, such as:
 - o Used units in the system
 - o Used outputs (0 to 10V and bus)
- Filter settings for actual force value and analog output
- Create the connection diagram for your specific system layout (see chapter "Electrical Connection")

4.2 Mounting Sequence

- Mount the force sensors (mounting details can be obtained from the mounting instructions of the force sensors)
- Connect the force sensors to the amplifier (see 4.5)
- Connect the amplifier to the supply voltage. The voltage supply must be in the range of 18 to 36 VDC. (See 4.5)
- Perform offset compensation and calibration (see 5.1 and 5.3)
- Change the parameter settings as needed (see **Fehler! Verweisquelle konnte nicht gefunden werden.**)
- Amplifier integration into the ETHERNET/IP network (see **Fehler! Verweisquelle konnte nicht gefunden werden.**)

4.3 Mounting and Electrical Connections



Warning

To improve natural convection and keep heating of the amplifiers as low as possible, the devices installed in a cabinet should have a minimum distance of 15 mm.



Warning

The function of the measuring amplifier is only ensured with the components in the specified layout to one another. Otherwise, severe malfunctions may occur. Thus, the mounting information on the following pages must be followed



Warning

The local installation regulations ensure the safety of electrical

systems. They are not considered in these operating instructions. However, they must be met.

4.4 Force sensor Mounting

The force sensors are mounted in line with the mounting instructions of the respective products. The mounting instructions are included with the force sensors.

4.5 Electrical Connections

One or two force sensors can be connected to the EMGZ491.EIP. When two sensors are used, they are connected in parallel internally. The force sensors and amplifier are connected using a 2x2x0.25 mm² [AWG 23] shielded, twisted cable.

4.5.1 EMGZ491.R.EIP

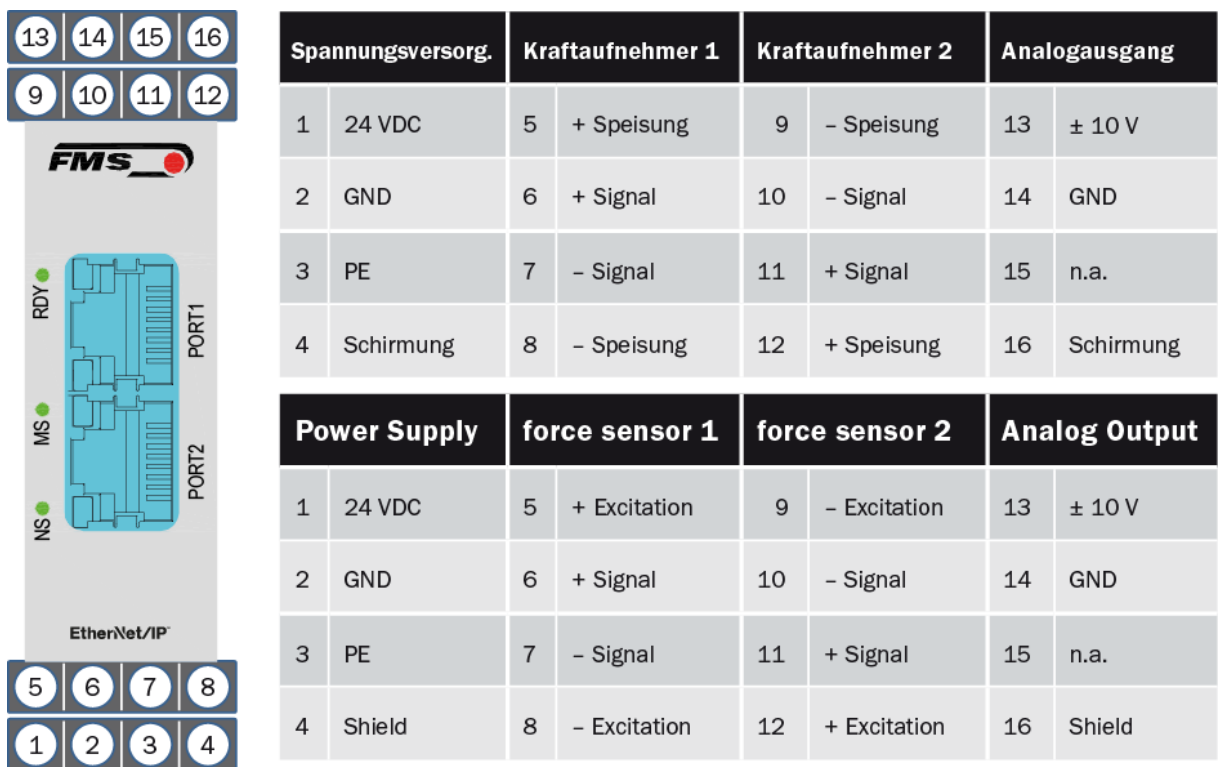

Figure 2: EMGZ491.R.EIP electrical connections

Color specifications (per IEC60757) and coding apply to FMS components only!



Figure 3: Detachable terminal blocks: use a small slotted screwdriver as a lever

4.5.2 EMGZ491.W.EIP

The 4 screws of the cover with the PG glands and the M12 plug must be loosened for board access. You can slide out the board by approx. 2 cm (1 in.) and loosen the terminal blocks for easier connection of the wires.

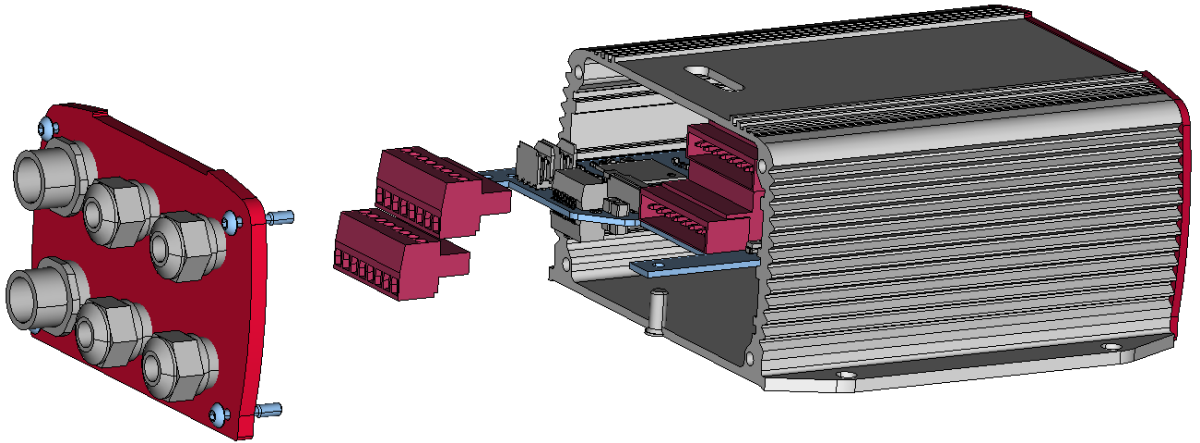

Figure 4: Pc board with removable terminal blocks

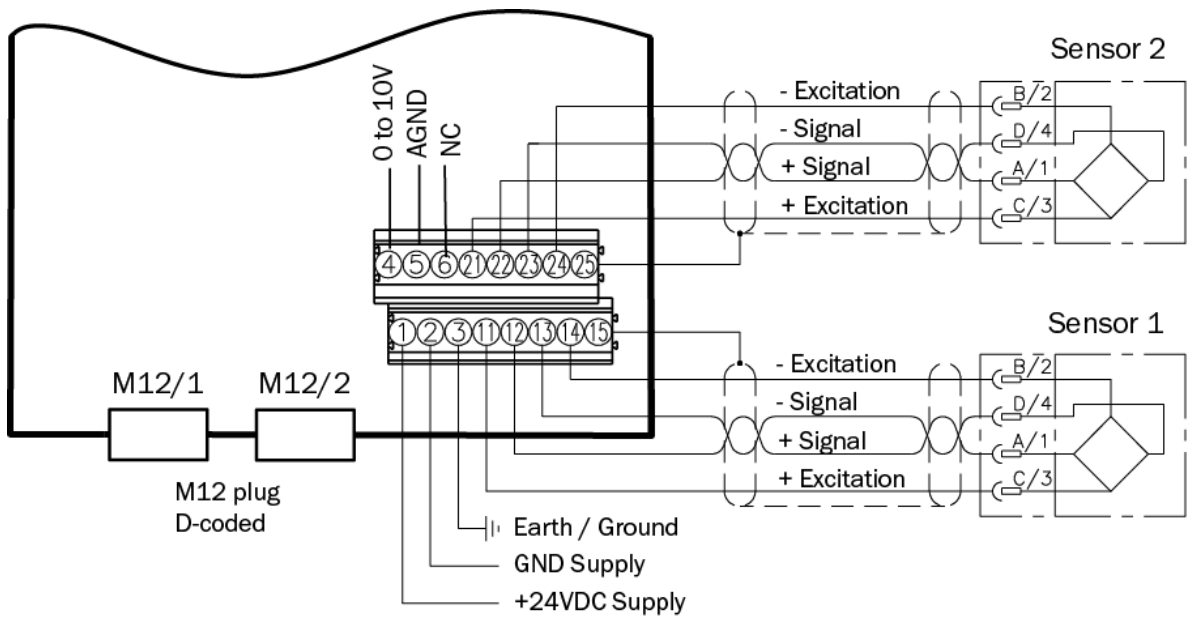

Figure 5: EMGZ491.W.EIP electrical connections

4.5.3 Ethernet Connections

Signal	Name	PROFINET	EIA T568B	Pin RJ45	Pin M12
TD+	Transmission Data +	YE	WH/OG	1	1
TD-	Transmission Data -	OG	OG	2	3
RD+	Receive Data +	WH	WH/GN	3	2
RD-	Receive Data -	BU	GN	6	4

Table 1: pin assignment Ethernet connection



Warning

Poor grounding can result in electric shocks for persons, malfunctions of the overall system or damage to the measuring amplifier! Proper grounding must always be ensured.



Note

Cable shielding may only be connected to one side of the measuring amplifier. On the side of the force sensor, shielding must remain open.

5 Calibration of the Measuring System

There are two options for performing the calibration:

- Via the web browser (see Fehler! Verweisquelle konnte nicht gefunden werden.)
- Directly in PLC

5.1 Offset Compensation

Using offset calibration, the weight of the measuring roller and the roller bearings is compensated and the measuring system “zeroed”.

Offset compensation must always be executed prior to the actual calibration. The measuring roller must not be loaded during the procedure.

5.2 Calibration (Adjusting the Gain Factor)

Calibration is used for matching the gain factor with the force sensors. After calibration, the displayed force corresponds to the force effectively affecting the material. Two calibration methods are available. The first calibration method described here uses a defined weight. There is also a calculation method for the gain. The weight-based calibration method is simple and delivers more accurate results as it replicates the material profile (see the figure below) and considers the actual circumstances in the machine.

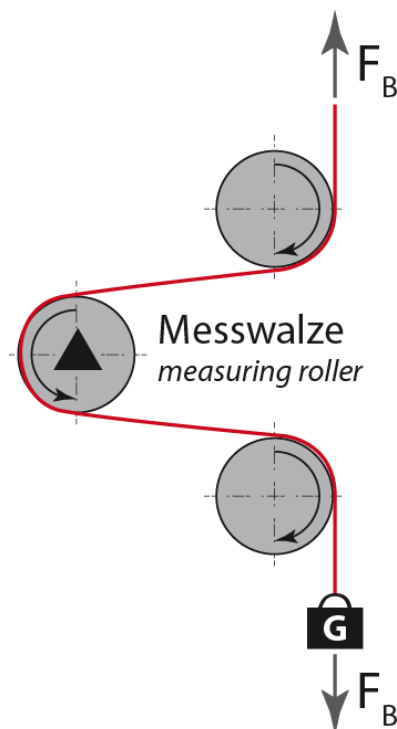

Figure 6: Replication of the material profile using a defined weight

5.3 Calibrating

- Activate the web interface (see **Fehler! Verweisquelle konnte nicht gefunden werden.**) and click on “Offset/Calibration” from the menu (see **Fehler! Verweisquelle konnte nicht gefunden werden.**).
- Connect the first force sensor (see 4.5).
- The measuring signal must become positive for loads in measuring direction. If it is negative, the signal lines of the affected force sensors must be switches at the terminal block (see 4.5).
- If available, connect the second force sensor.
- The measuring signal must become positive for loads in measuring direction. If it is negative, the signal lines of the affected force sensors must be switched at the terminal block (see 4.5).
- Click on “Adjust Offset” in the web browser.
- Insert material or rope into the machine.
- Load material or rope with a defined weight (see 5.2).
- Click on “Calibrate Gain” in the web browser.

5.4 Gain

Depending on the material wound around the measuring roller, the applied force is not relayed to the sensors 1:1. Thus, the measured force does not correspond to the effectively applied force. To correct for this error, the measured force is amplified using a factor. The factor that is referred to as gain or gain factor is calculated such that the resulting force corresponds to the applied force. The gain is calculated per the following formula:

$$\text{Gain} = \frac{F_{\text{sys Digit}} * F_{\text{act N}}}{F_{\text{sys N}} * F_{\text{act Digit}}}$$



Option V05

The standard version uses a sensor feedback signal of ± 9 mV. Measuring amplifiers with the option V05 are designed for a sensor feedback signal of ± 2.5 mV. The other values in the following description are identical.

Explanations	
Variable	Description
F_{sys Digit}	Is the system force as binary value after the A/D converter. This value is a constant with value 11'890. It is independent from the number of used force sensors. From the user's point of view, this value corresponds to an input signal of 9 mV. The amplifier can measure up to an overload of 37 %.
F_{act N}	Effectively applied force at the measuring system in Newtons.

$F_{\text{sys N}}$	Is the system force of the measuring system in Newtons. It is determined by the number of used force sensors. For one force sensor, the system force equals the nominal force of the force sensor. For two sensors, it is twice as high.
$F_{\text{act Digit}}$	Measured force at the measuring system as binary value after the A/D converter. From the user's point of view, this value corresponds to a voltage in mV, which is relayed by the measuring system to the amplifier.

Example

- System force at 9 mV = 11'890 digit
- 2 force sensors with 500 N nominal force each, as per type plate; $F_{\text{sys N}} = 2 \times 500 \text{ N} = 1'000 \text{ N}$;
- Use of a defined weight of 50 kg (corresponds to approx. 500 N); $F_{\text{act N}} = 500 \text{ N}$
- Obtain measured force with suspended weight from the PLC, e.g., $F_{\text{act Digit}} = 4'980$

$11'890 \times 500\text{N}$	
Gain =	$\frac{\text{---}}{1'000\text{N} \times 4'980} \text{V} = 1.194$



Note

This calculation is not required when calibrating via web browser.

5.5 Limit Value Violations

The amplifier checks the analog input and output for limit value violations. At the input, it is checked using the input voltage, whether the force sensor is mechanically overloaded (overload test). The measuring amplifier can measure an overload of 37 %. At the output, it is checked, whether the output voltage depending on the amplified input signal will be above or below the physically possible value. In this case, an overflow and/or underflow is present.

5.5.1 Overload Test

The overload test is performed using the raw value read on the ADC. It has thus not related to any force and can be applied independently from the system force to every force sensor.

Test rule:

The FMS force sensors deliver 9 mV at the output under nominal force load. In the case of a load up to the mechanical stop, approx. 12.4 mV are output. These values apply, if the force sensor is loaded in normal operating direction (red point). In reverse direction, the values are respectively negative. The amplifier checks overload in both directions.

The limit value for overload is fixed set to 12 mV and/or -12 mV. If one of these limit values is reached, the overload status bit is set. The bit is removed again, as soon as the raw value is 0.5 mV below and/or above the triggering limit value.

5.5.2 Overflow and Underflow Test

The overflow and underflow test is performed with the output value that is relayed to the DAC, calculated from the gain. If the output value exceeds the maximum possible value, an overflow is present. If it undercuts the minimum possible value, an underflow is present.

Test rule

The output voltage is between 0 and +10 V. A hysteresis of +/-10 digits is used for the test so that the error bits do not trigger for every small over- and/or underflow. Thus, the overflow triggers, when the theoretically calculated output value of 10.05 V is reached. For underflow, the value is 0.05 V. When these limit values are reached, the respective bits are set in the status. The bits are removed, as soon as the output value is within the valid range again (above 0.05 V and below 9,95 V).

5.6 Description of the LEDs

LED	Meaning
PORT1	Port 1 Ethernet cable 1 connected and linked with counter point
PORT2	Port 2 Ethernet cable 1 connected and linked with counter point
MS	Green, on: in operation, ok Green, flashing: standby Green, red flashing: self-test Red, flashing: simple error Red, on: severe error
NS	Green, on: connected Green, flashing: not connected Green, red flashing: time-out connection Red, on: dual IP
RDY	Illuminates in green as soon as the voltage supply is connected and the processor is started.

Figure 7: Signal LEDs on EMGZ491.EIP

6 Integration into the EtherNet/IP Network

The measuring amplifiers of the EMGZ491.EIP series can operate in an EtherNet/IP network. Here, the amplifier operates as EtherNet/IP-adapter with the PLC which has the role of a EtherNet/IP-scanner.

6.1 EtherNet/IP Interface

EtherNet/IP is supported. The respective communication profile is selected by the controller (master) via the EDS file.

The EDS file from FMS will support the EDS-AOP License Key of Rockwell.

The EMGZ491.EIP transfers the actual value in digit and the status/error byte. In addition, parameters, such as offset actual value, gain actual value, filter actual value, filter analog output, as well as scaling analog output can be adjusted.

EDS and example files as well as a quick start guide are available in the download section on www.fms-technology.com.

The Quick Start Guide describes how to integrate the EMGZ491/492 into the PLC development environment.

EMGZ49x with software version up to 2.0.3, the EDS version 1.1 must be used.

EMGZ49x with software version from 2.0.4 or higher, the EDS version 2.1 must be used.

6.2 TCP/IP Configuration

The Ethernet settings must be known for PLC or web browser to communicate with the amplifier in a ETHERNET/IP network. The system developer configures the address for every device and has thus a general overview of the address allocation in the network.

The IP address of the amplifier is factory pre-set to 192.168.0.90.

6.3 Data Exchange

The EMGZ491.EIP uses the communication types typical for EtherNet/IP. Cyclic data traffic is used for the fast transmission of measured data. Acyclic data traffic is used for parameterization. Cyclic data traffic is used for transmitting the limit value violations.

7 Configuration

The EMGZ491.EIP can be configured either via the web interface or via ETHERNET/IP.

The parameters “Low-pass filter active” and “Low-pass filter analog output active” cannot be accessed via the web interface.

7.1 Modify IP address with RSLinx

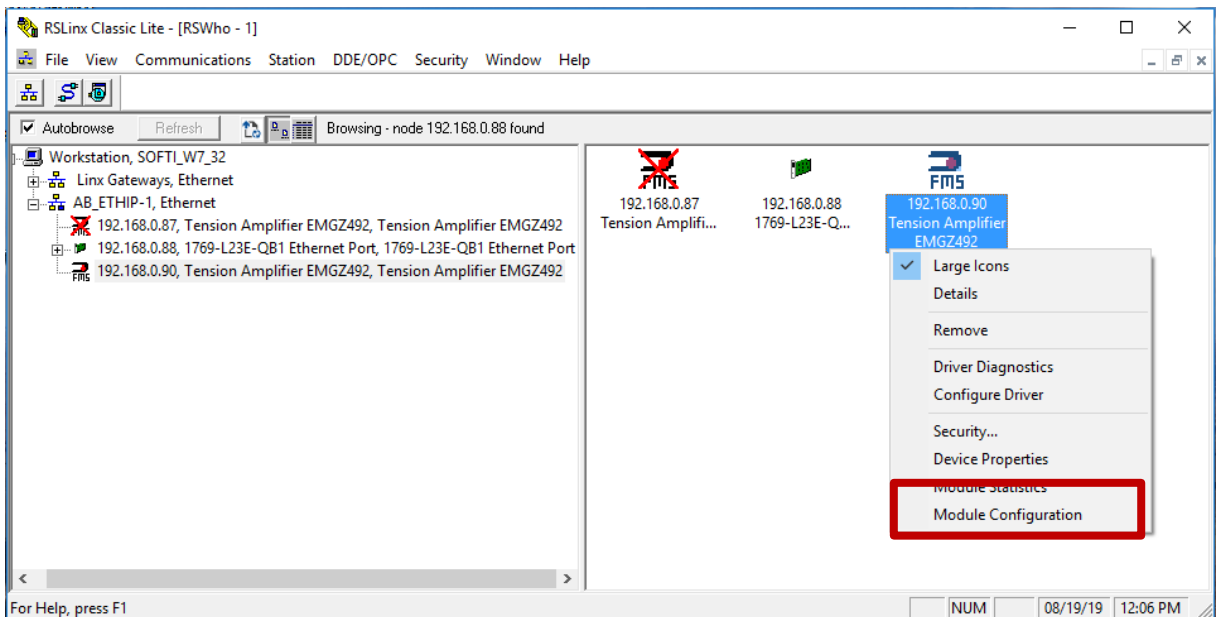

AB_ETHIP-1\192.168.0.90 Tension Amplifier EMGZ492 Configuration

General Port Configuration Advanced Port Configuration Network

Port: 1

Manually configure IP settings
 Obtain IP settings automatically using BOOTP
 Obtain IP settings automatically using DHCP

IP Address: 192 . 168 . 0 . 90

Network Mask: 255 . 255 . 255 . 0

Gateway Address: 0 . 0 . 0 . 0

Primary Name Server: 0 . 0 . 0 . 0

Secondary Name Server: 0 . 0 . 0 . 0

Domain Name:

Host Name: Tension Amplifier EMGZ492

Status: Network Interface Configured

OK Abbrechen Übernehmen Hilfe

ControlLogix Gateway Tool

Changing the IP Address of this modules will cause all connections routed through this module to become broken.

Do you wish to continue?

Ja Nein

7.2 Parameter Description

Access daa with RSLogix 5000

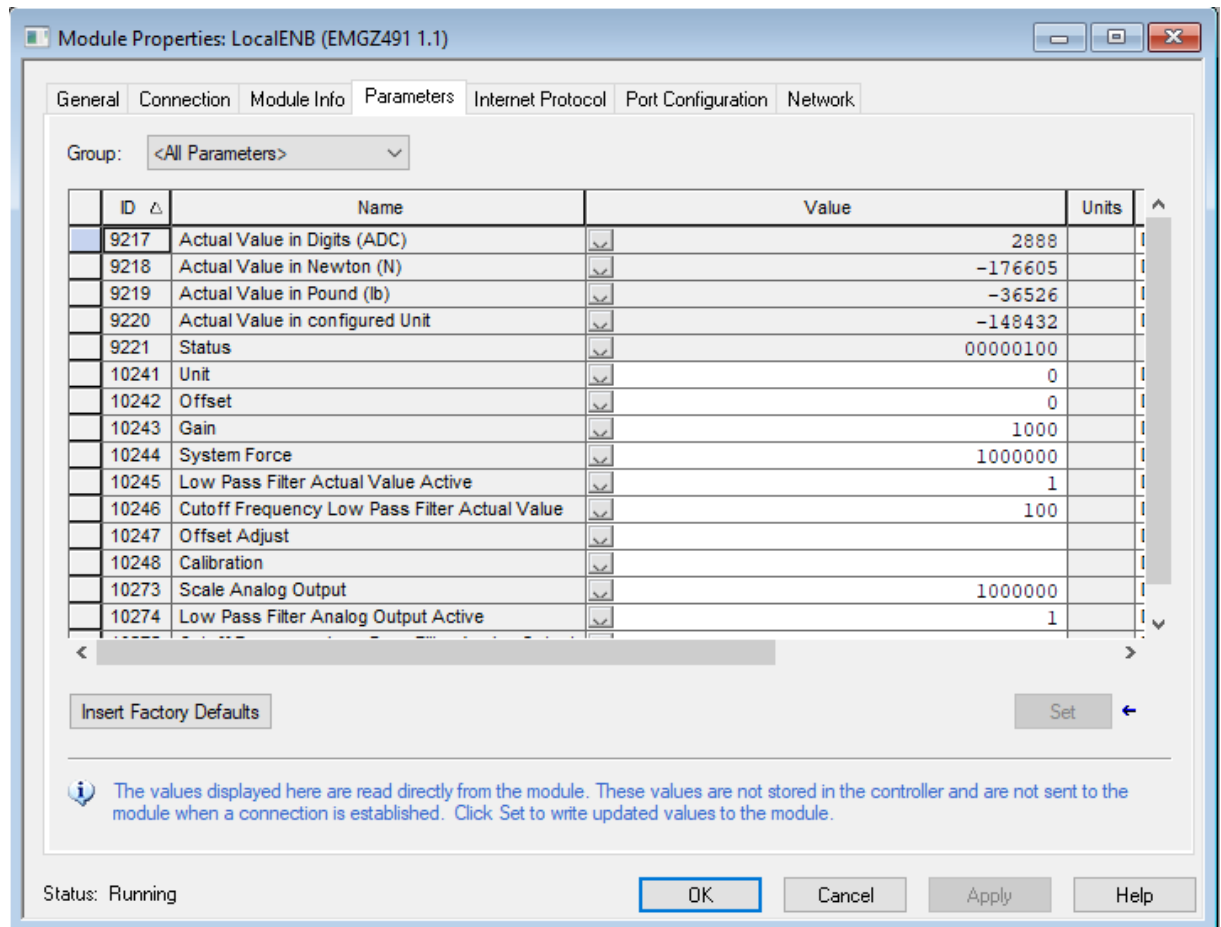

Parameter	
Name	Description
Unit	<p>Here you select which unit of measurement is used. The label located on the sensor will indicate the nominal force in Newtons.</p> <p>Note:</p> <p>This input will also affect the unit of the cyclic process data.</p> <p>If lb (pound) is selected, the system switches from metric to imperial measuring units.</p> <p>Selection N, kN, lb, g, kg</p> <p>Specified value N</p>

Offset	<p>The values determined with the “Offset Compensation” procedure are stored in the form of a digital value in the [Offset] parameter. The value is used for compensating for the roller weight.</p> <p>Min. -16'000</p> <p>Max. 16'000</p> <p>Specified value 0</p>
Gain	<p>The gain factor ensures that the displayed force matches the effective force.</p> <p>Min. 0.100</p> <p>Max. 20.000</p> <p>Specified value 1.000</p>
System force	<p>The system force indicates which measuring force capacity is installed in the measuring roller. E.g., if two 500 N force sensors are installed in the roller, 1'000 N must be entered. In the case of a one-sided measurement, hence is one 500 N force sensor is used, 500 N must be entered. If force measuring rollers with pulleys are used (e.g., RMGZ series), the nominal force of the force measuring roller must be specified (in the example 500 N as well)</p> <p>Unit N</p> <p>Min. 1.00</p> <p>Max. 200'000.00</p> <p>Specified value 1'000.00</p>
Low-pass filter active	<p>Here, the status of the low-pass filter active value is indicated.</p> <p>This parameter cannot be accessed via the web interface.</p> <p>Min. 0</p> <p>Max. 1</p> <p>Specified value 1</p> <p>0 = no, inactive, 1 = yes, active</p>

<p>Limit frequency low-pass filter actual value</p>	<p>The amplifier features a low-pass filter that filters the measured value, which is relayed via ETHERNET/IP. This filter is used for suppressing undesired interference signals that are superimposed on the measuring signal. Using this parameter, the limit frequency of the filter is adjusted. The lower the limit frequency, the slower the measuring value.</p> <p>This low-pass filter is independent from the output filter.</p> <p>Unit Hz</p> <p>Min. 0.1</p> <p>Max. 200.0</p> <p>Specified value 10.0</p>
<p>Low-pass filter analog output active</p>	<p>Here, the status of the low-pass filter for the analog output is indicated.</p> <p>This parameter cannot be accessed via the web interface.</p> <p>Min. 0</p> <p>Max. 1</p> <p>Specified value 1</p> <p>0 = no, inactive, 1 = yes, active</p>
<p>Limit frequency low-pass filter analog output</p>	<p>The amplifier features a low-pass filter that filters the signal of the analog voltage output. This filter is used for suppressing undesired interference signals. Using this parameter, the limit frequency of the filter is adjusted.</p> <p>This low-pass filter is independent from the ETHERNET/IP filter.</p> <p>Unit Hz</p> <p>Min. 0.1</p> <p>Max. 200.0</p> <p>Specified value 10.0</p>
<p>Analog output scaling</p>	<p>This parameter determines, for which force the analog output outputs its maximum voltage (10 V).</p> <p>Note:</p> <p>If lb (pound) is selected, the system switches from metric to imperial measuring units.</p> <p>Unit N</p> <p>Min. 0.1</p> <p>Max. 200'000.00</p> <p>Specified value 1'000.00</p>

7.3 Cyclic Data Traffic

After a successful system start, controller and the assigned devices can exchange cyclic process data. The table below shows the measured data and how they are transmitted.

Parameter	
Name	Description
Actual value in ADC	<p>Value read in via the A/D converter.</p> <p>Data type int (signed 16 bit)</p> <p>Value range -16384 to 16383</p> <p>Value format ±#####</p> <p>The value is interpreted as integer without decimal place. E.g. 1000 = 1000 ADC raw value</p>
Actual value in Newton	<p>Filtered actual value converted into Newton</p> <p>Data type long (signed 32 bit)</p> <p>Value range ±200'000'000</p> <p>Value format ±#####.###</p> <p>The value is interpreted as decimal number with 3 decimal places. E.g. 1500 = 1.500 N (1.5 N)</p> <p>Unit N</p>
Actual value in pound	<p>Filtered actual value converted into pound.</p> <p>Data type long (signed 32 bit)</p> <p>Value range ±200'000'000</p> <p>Value format ±#####.###</p> <p>The value is interpreted as decimal number with 3 decimal places. E.g. 224820 = 224.820 lb (224.82 lb)</p> <p>Unit lb</p>

<p>Actual value in unit</p>	<p>Filtered actual value converted into configured unit.</p> <p>Data type long (signed 32 bit)</p> <p>Value range ±200'000'000</p> <p>Value format ±#####.### for N, kN, kg, or lb</p> <p>The value is interpreted as decimal number with 3 decimal places. E.g. unit set to kN 100000 = 100.000 kN (100 kN)</p> <p>Value format ±#####.# for g</p> <p>The value is interpreted as decimal number with 1 decimal place. E.g. unit set to g 12340 = 1234.0g (1234g)</p>
<p>Status</p>	<p>The status contains information about the current process and operating condition.</p> <p>Every bit represents a separate event. The condition is active, if the bit is set.</p> <p>Data type byte (unsigned 8 bit)</p> <p>Bit 0 Overload (LSB)</p> <p>Bit 1 Analog output overflow</p> <p>Bit 2 Analog output underflow</p>

7.4 Acyclic Data Traffic

After a successful system start, controller and the assigned devices can exchange acyclic requirement data. The following table shows the parameters and commands ad how they are transmitted using acyclic data traffic.

Parameter	
ID	Description
10241	<p>Unit</p> <p>Access type R/W</p> <p>Parameter command unit</p> <p>Data type byte (unsigned 8 bit)</p> <p>Value range 0 to 4 0=N; 1=kN; 2=lb; 3=g; 4=kg</p> <p>Value format #</p>
10242	<p>Offset</p> <p>Access type R/W</p> <p>Parameter command offset</p> <p>Data type int (unsigned 16 bit)</p> <p>Value range -16'000 to 16'000</p> <p>Value format ±#####</p>
10243	<p>Gain</p> <p>Access type R/W</p> <p>Parameter command gain</p> <p>Data type int (unsigned 16 bit)</p> <p>Value range 100 to 20'000</p> <p>Value format ##.###</p>

<p>10244</p>	<p>System force</p> <p>The system force is the maximum permissible force of the used measuring system.</p> <p>Access type R/W</p> <p>Parameter command system force</p> <p>Data type long (unsigned 32 bit)</p> <p>Value range 0 to 200'000'000</p> <p>Value format #####.###</p> <p>Unit N</p>
<p>10245</p>	<p>Low-pass filter active</p> <p>Switch the low-pass filter actual value on or off; 0 = off; 1 = on.</p> <p>Not remanent: The adjusted value is lost on a restart! This filter is switched on after a restart.</p> <p>This parameter cannot be accessed via the web interface.</p> <p>Access type R/W</p> <p>Parameter command low-pass filter actual value active (ETHERNET/IP)</p> <p>Data type byte (unsigned 8 bit)</p> <p>Value range 0 to 1</p> <p>Value format #</p>
<p>10246</p>	<p>Limit frequency low-pass filter actual value</p> <p>Limit frequency of the low-pass filter for the actual value outputted via ETHERNET/IP.</p> <p>Access type R/W</p> <p>Parameter command limit frequency low-pass filter actual value (ETHERNET/IP)</p> <p>Data type int (unsigned 16 bit)</p> <p>Value range 1 to 2'000</p> <p>Value format ###.#</p> <p>Unit Hz</p>

<p>10247</p>	<p>Offset adjustment</p> <p>Determine and store offset. The system is set to zero without material tension.</p> <p>Access type W</p> <p>Parameter command offset adjustment</p> <p>Data type byte (unsigned 8 bit)</p> <p>Value range 0 to 1</p> <p>Value format #</p> <p>To use the offset function a “1” must be written to the device. A reset is not necessary. Every time a “1” is written the offset is evaluated.</p>
<p>10248</p>	<p>Calibration</p> <p>Calibrates the amplifier to the weight in Newton, which is handed over here. It must match the suspended weight.</p> <p>Access type W</p> <p>Parameter command calibration</p> <p>Data type long (signed 32 bit)</p> <p>Value range 0 to 200'000'000</p> <p>Value format #####.###</p> <p>Unit N</p> <p>Every time a force in Newton is written the gain is evaluated. A reset to zero is not necessary.</p>

Explanation of access types: R = Read, W = Write, R/W = Read and Write.

<p>10273</p>	<p>Analog output scaling</p> <p>Determines, at which force the analog output outputs the maximum value of 10 V.</p> <p>Access type R/W</p> <p>Parameter command analog output scaling</p> <p>Data type long (unsigned 32 bit)</p> <p>Value range 100 to 200'000'000</p> <p>Value format #####.###</p> <p>Unit N</p>
<p>10274</p>	<p>Low-pass filter analog output active</p> <p>Switch the low-pass filter analog output on or off; 0 = off; 1 = on.</p> <p>Not remanent: The adjusted value is lost on a restart! This filter is switched on after a restart.</p> <p>This parameter cannot be accessed via the web interface.</p> <p>Access type R/W</p> <p>Parameter command low-pass filter analog output active</p> <p>Data type byte (unsigned 8 bit)</p> <p>Value range 0 to 1</p> <p>Value format #</p>
<p>10275</p>	<p>Limit frequency low-pass filter analog output</p> <p>Limit frequency of the low-pass filter for the actual value outputted via the analog output.</p> <p>Access type R/W</p> <p>Parameter command limit frequency low-pass filter analog output</p> <p>Data type int (unsigned 16 bit)</p> <p>Value range 1 to 2'000</p> <p>Value format ###.#</p> <p>Unit Hz</p>

Explanation of access types: R = Read, W = Write, R/W = Read and Write.

8 EtherNet/IP Communication

Using acyclic data exchange, IO devices (slaves) can be parameterized, configured, or status information read out. For this purpose, read/write frames via IT standard services using UDP/IP are used.

8.1 General Function

The read/write commands can be triggered, when the controller is connected to the IO device, hence a “Connect” took place.

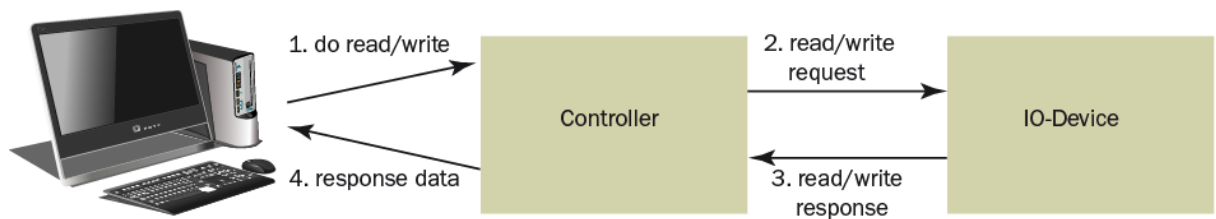

Figure 8: Read/Write cycle

A computer with the respective application can now request a “read” or “write” on the data model of the controller. The controller executes the read/write command via ETHERNET/IP and returns status and data to the computer.

8.2 Services and Protocols

The following services and protocols are used:

- Get_Attribute_Single
- Set_Attribute_Single
- gemäss CIP Spezifikation Volume 1 und Volume 2

All other services required for EtherNet/IP are permissible as well.

The services above can be used with the EMGZ491.EIP at any time.

9 Web interface

You can also configure the amplifier using a PC or laptop. The PC is connected to the amplifier via a peer-to-peer connection.

9.1 Peer-to-Peer connection with laptop

For this connection, your laptop must be assigned an IP address in the static block (not obtained via DHCP).

The IP address of the amplifier is set to 192.168.000.090 at the factory.



IP-address of PROFINET and Ethernet/IP devices

The IP address of PROFINET and Ethernet/IP devices is set to 0.0.0.0 at the factory, as these are usually configured via the PLC.

If you want to configure these devices via the web interface, you must first set the IP address manually.

Gehen Sie dafür wie folgt vor:

Schritt 1: siehe 9.2 Assign static IP-address to laptop, Seite 28.

Schritt 2: siehe 9.5 Ethernet Device Configuration Tool, Seite 36

Schritt 3: siehe 9.4 Web interface, Seite 32

9.2 Assign static IP-address to laptop

The example shows the configuration for Windows 10 (with German interface). The display may vary depending on the operating system.

1. connect PC and amplifier with an RJ-45 patch cable
2. start PC and amplifier
3. click on the start button of your PC (bottom left corner of your screen)



4. Click settings

5. Click network and internet

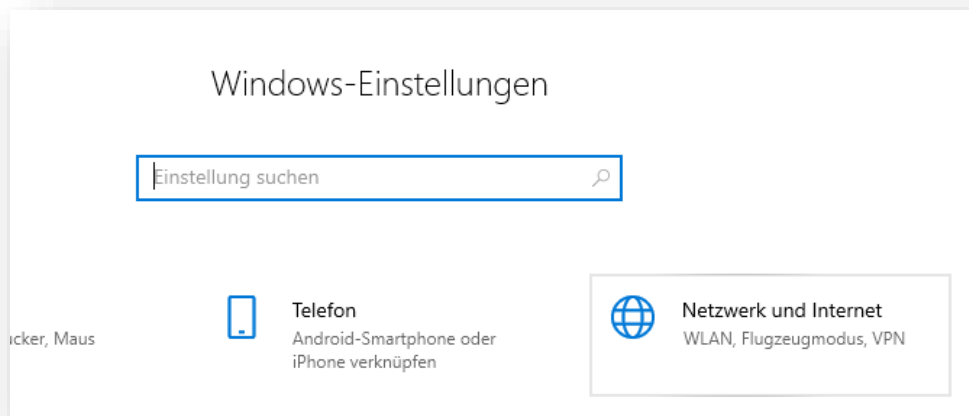

6. Select Ethernet in navigation on the left hand side of the screen

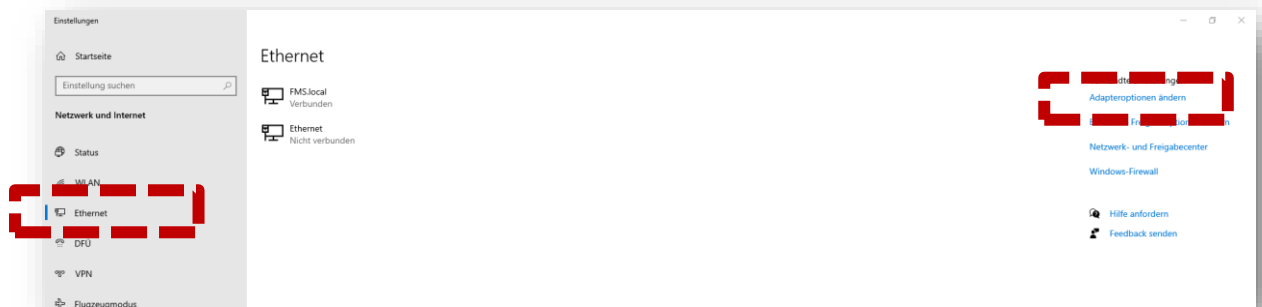

7. Select change adapter options

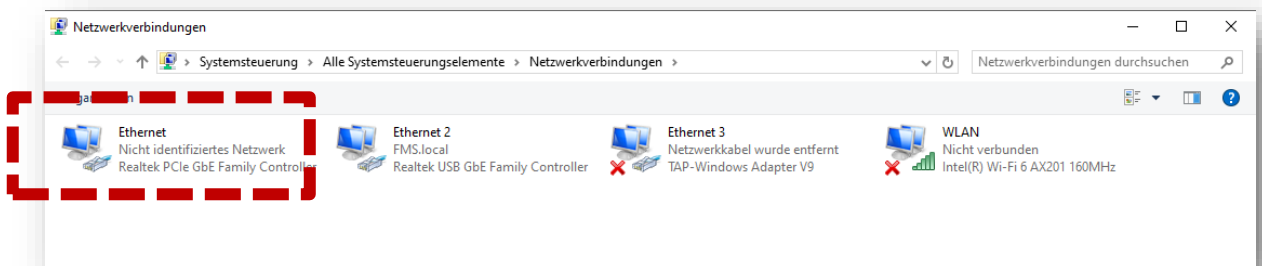

8. select the desired adapter (of the Ethernet socket used on your laptop), here in the example: Ethernet, Unidentified network

9. double-click to select

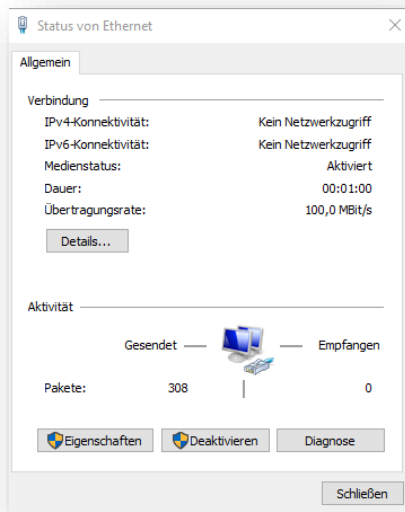

10. Select properties

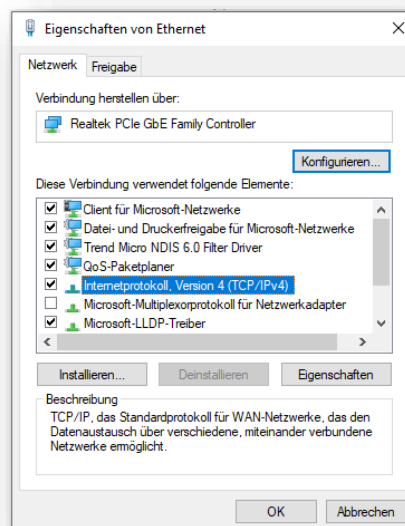

11. Internet protocoll, Version 4 (CP/IPv4)

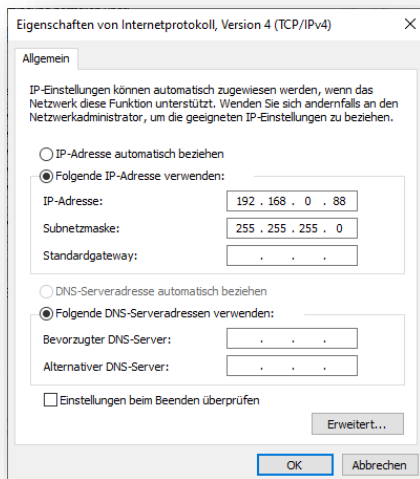

12. activate "Use the following IP address"
13. please check with your IT department which address you may enter here.
14. enter an IP address here.
15. Subnet mask is filled in automatically
16. confirm with OK.
17. the laptop is now ready to communicate with the amplifier.

9.3 Connect device with laptop

1. open any web browser: Microsoft Internet Explorer, Mozilla Firefox, Edge, Chrome, or similar...
 2. the factory setting for the IP address of the amplifier is 192.168.0.90.
 3. if nothing has been changed, enter this IP address in the input field (e.g. <http://192.168.0.90>) and confirm with "Enter".
- the user interface of the web interface appears.

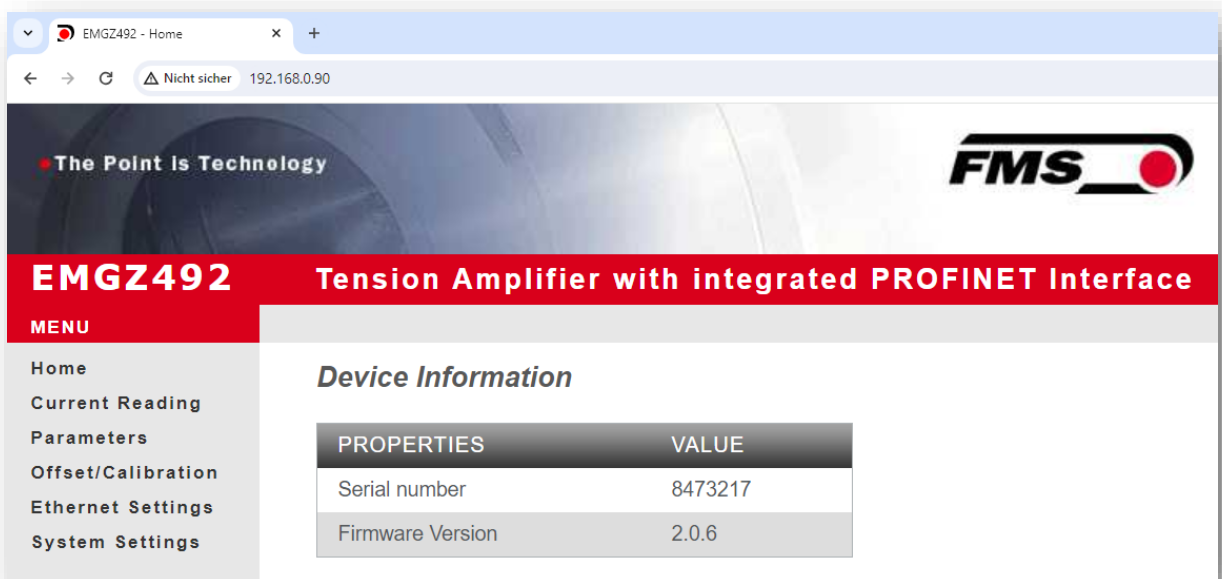

9.4 Web interface

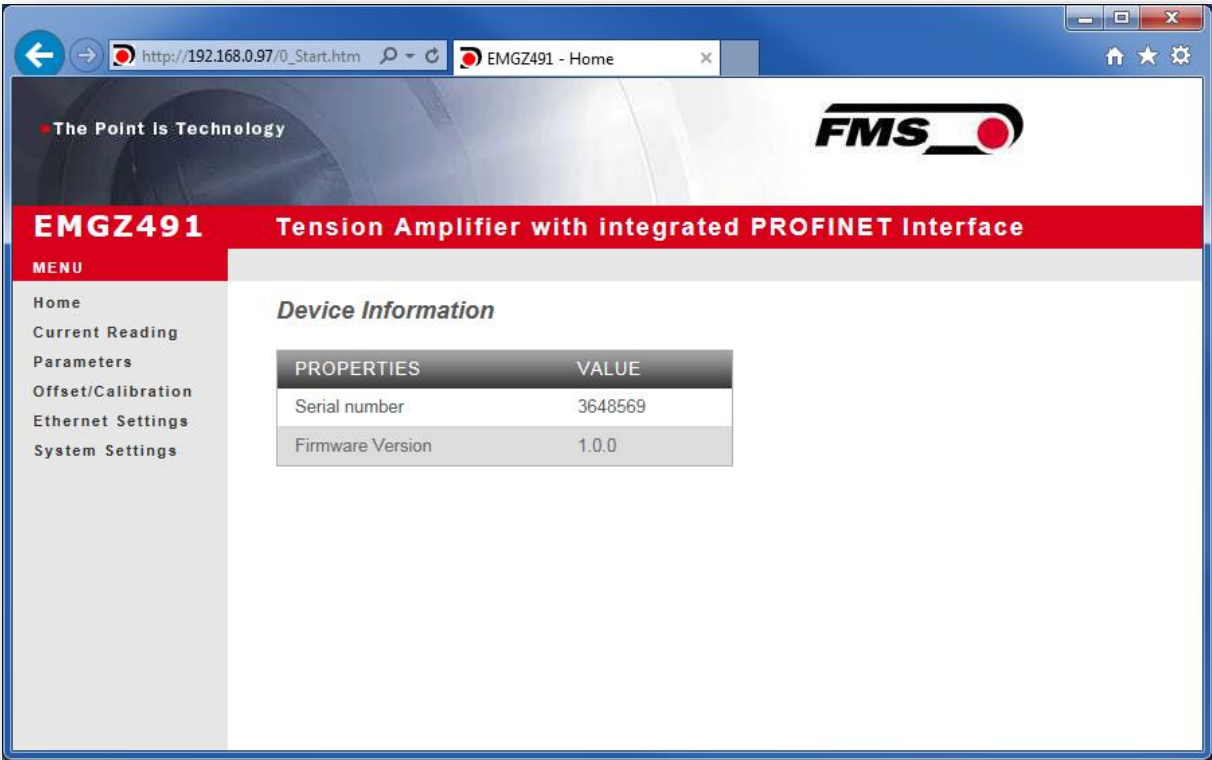

Figure 1: Home

The Home page provides information about general device properties such as the serial number and software version.

The menu on the left-hand side of the screen allows you to navigate around the page.

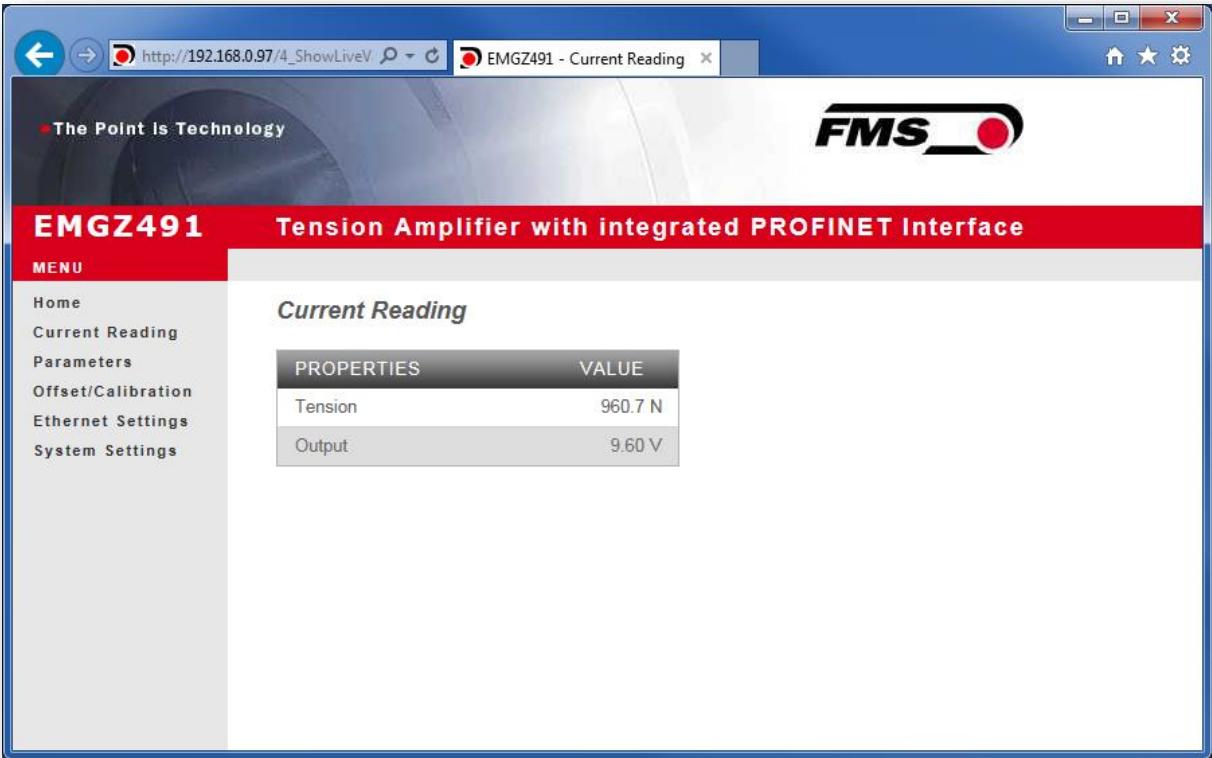

Figure 2: Current Reading

The Current Reading web page displays all current values of the amplifier. The first line Tension shows the tension measured at the input in the set unit of measurement. The second line Output shows the output voltage in volts.

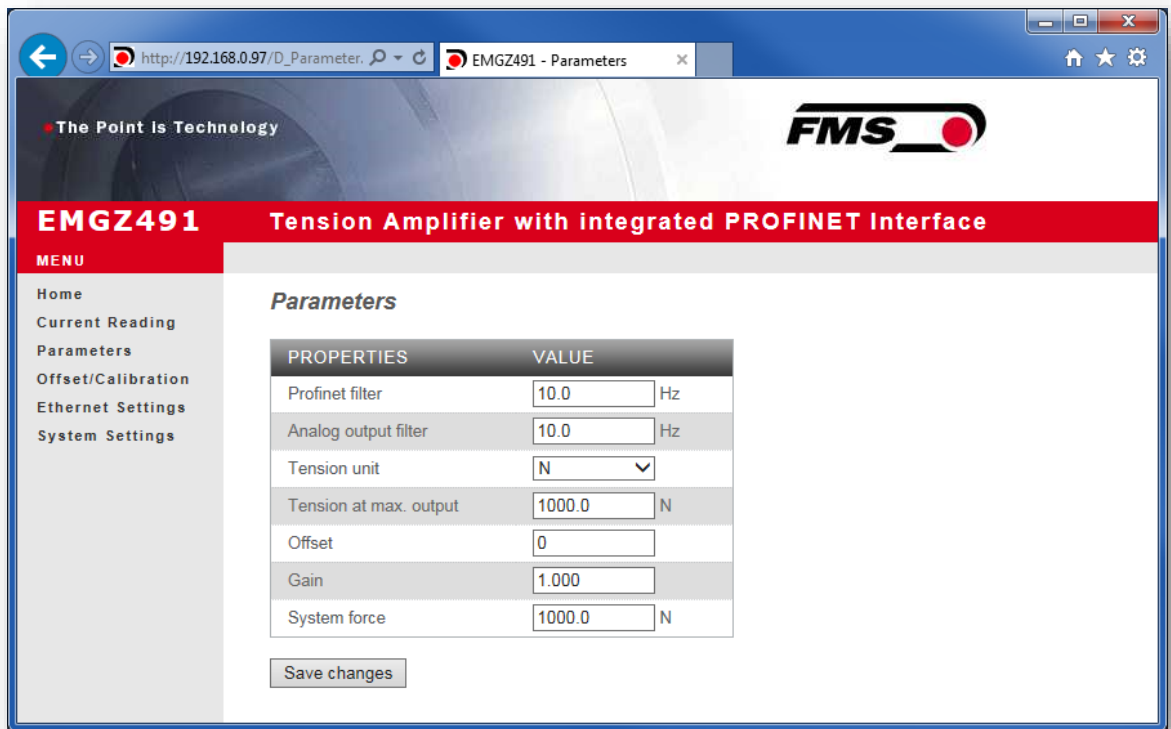

Figure 3: Parameters

The Parameters page offers the option of configuring the amplifier via the web interface.

The parameters "Low-pass filter active" and "Low-pass filter analog output active" cannot be accessed via the web interface.

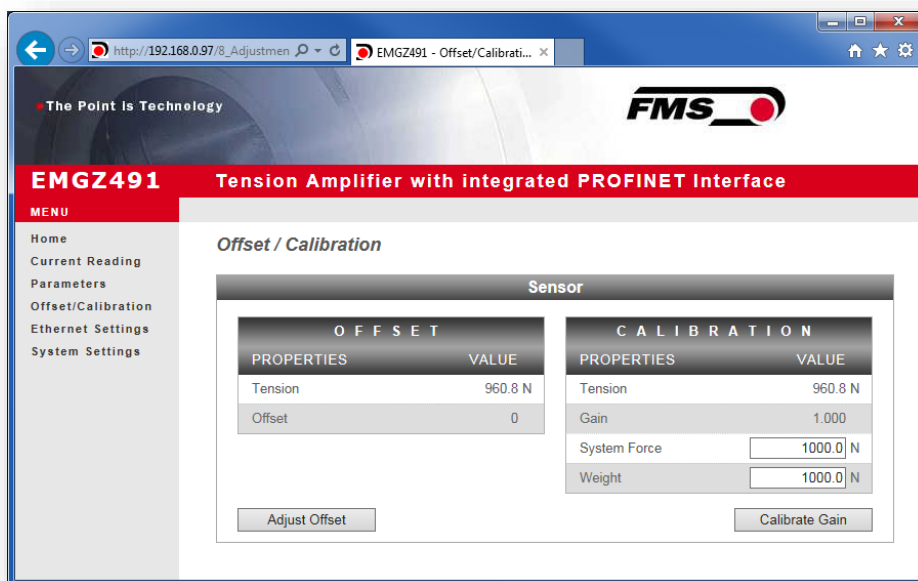

Figure 4: Offset/Calibration

The Offset/Calibration page is available for adjusting the amplifier. This page can be used to adjust the offset and then perform the calibration.

These functions are also available via the PLC. If the values for offset and gain are known, they can also be assigned directly to the corresponding parameters.



i Confirm input

Always use the button “save input” to confirm your input and NOT the Enter key.

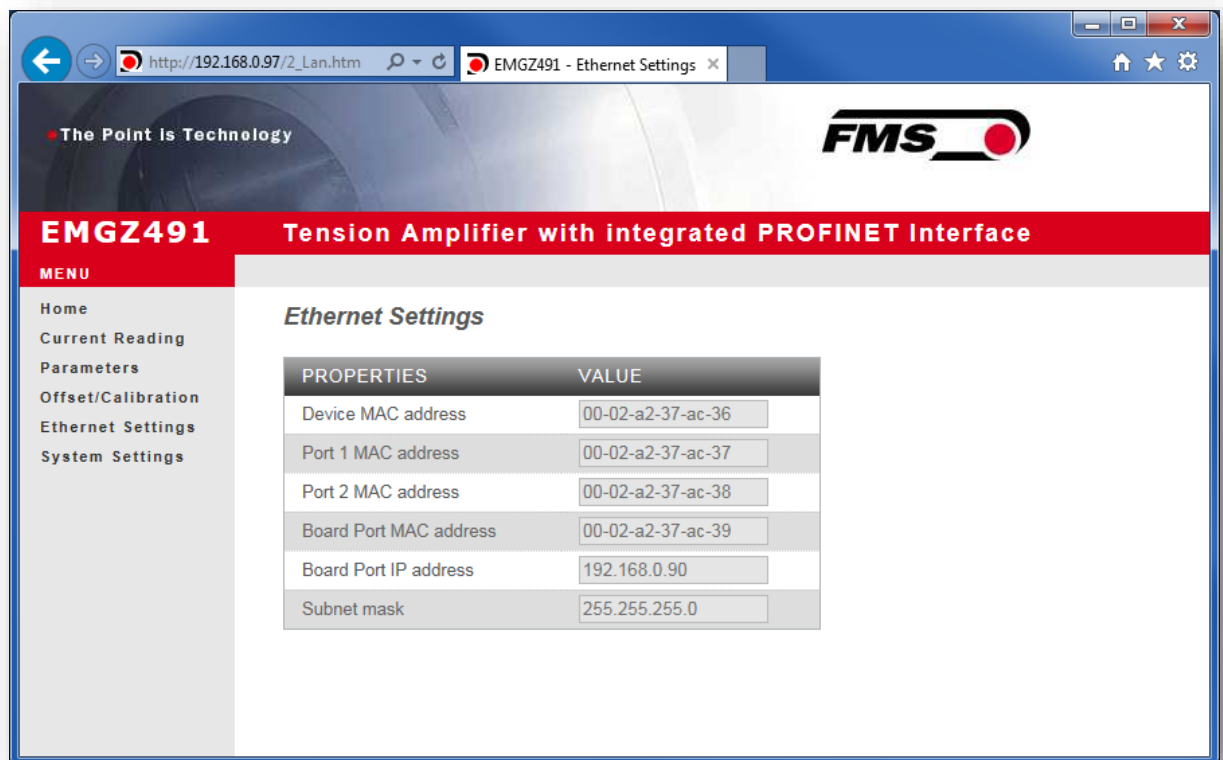

Figure 5: Ethernet settings

This page shows the current TCP/IP configuration. It cannot be changed via the web interface, only read.

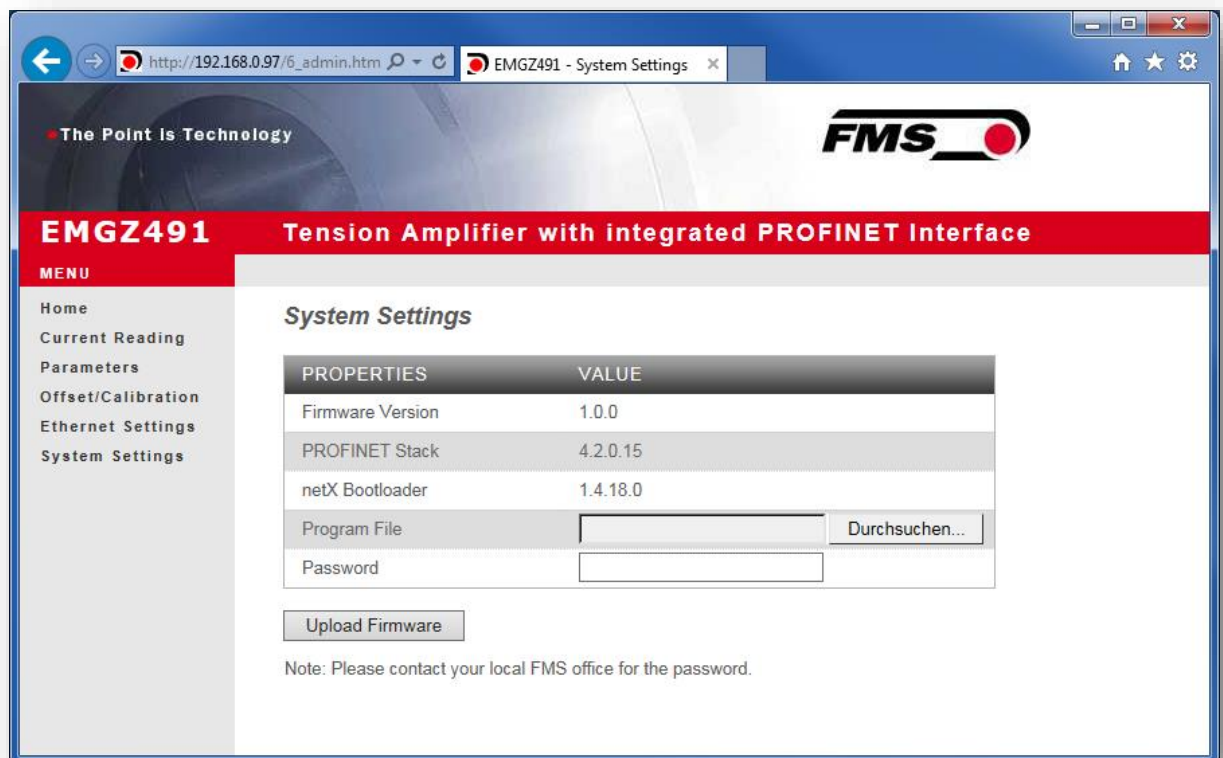

Figure 6: System-Einstellungen

The internal firmware version can be viewed on the System Settings page. New firmware can also be loaded here.

Current firmware files can be found in the download area on our website.

9.5 Ethernet Device Configuration Tool

To change the IP address on the amplifier, use the free "Ethernet Device Configuration" program. It can be downloaded here free of charge.

<https://www.fms-technology.com/en/downloadcenter/profinet>

If you accidentally change the IP address during configuration in the PLC, you can use this software to find the device again in the network environment at any time.

The following steps were created with PROFINET device. The views for Ethernet/IP may differ.

1. start the program via the icon on the desktop



2. press «search devices»
3. a list of all devices is displayed

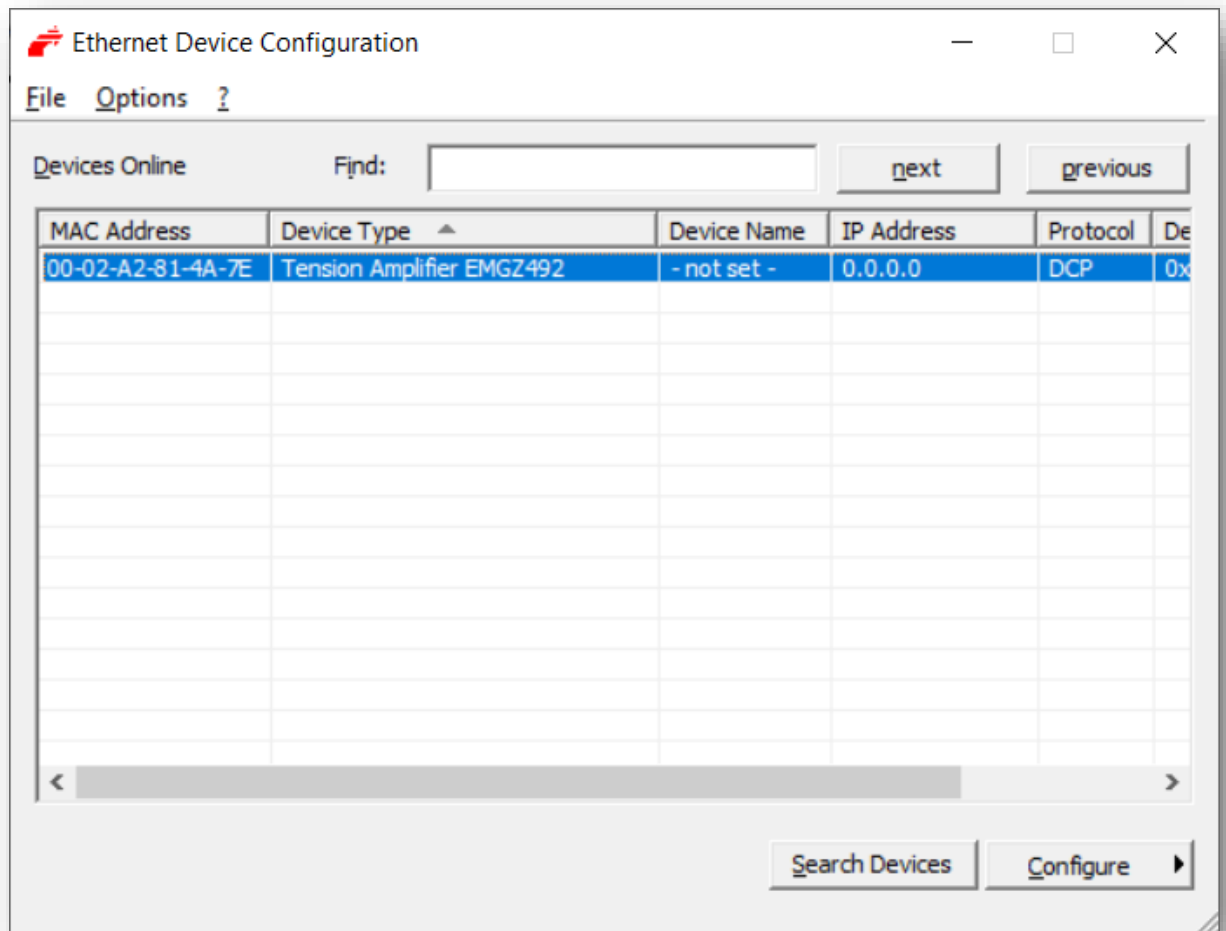

4. select the line with the corresponding device
5. press the "Configure" and "Set IP address..." button

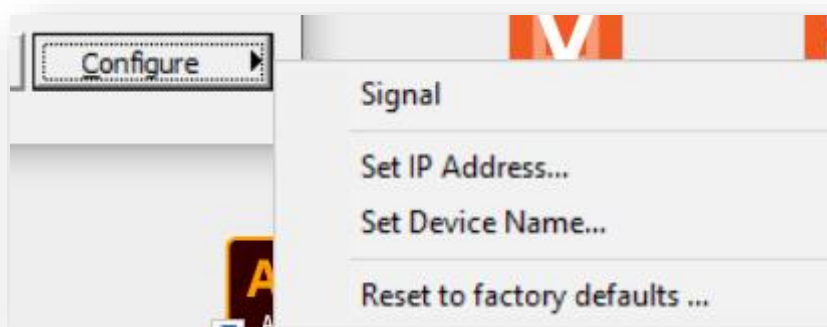

6. if you only want to save the changes temporarily - until the measuring amplifier is restarted - activate the "Store settings temporarily" button

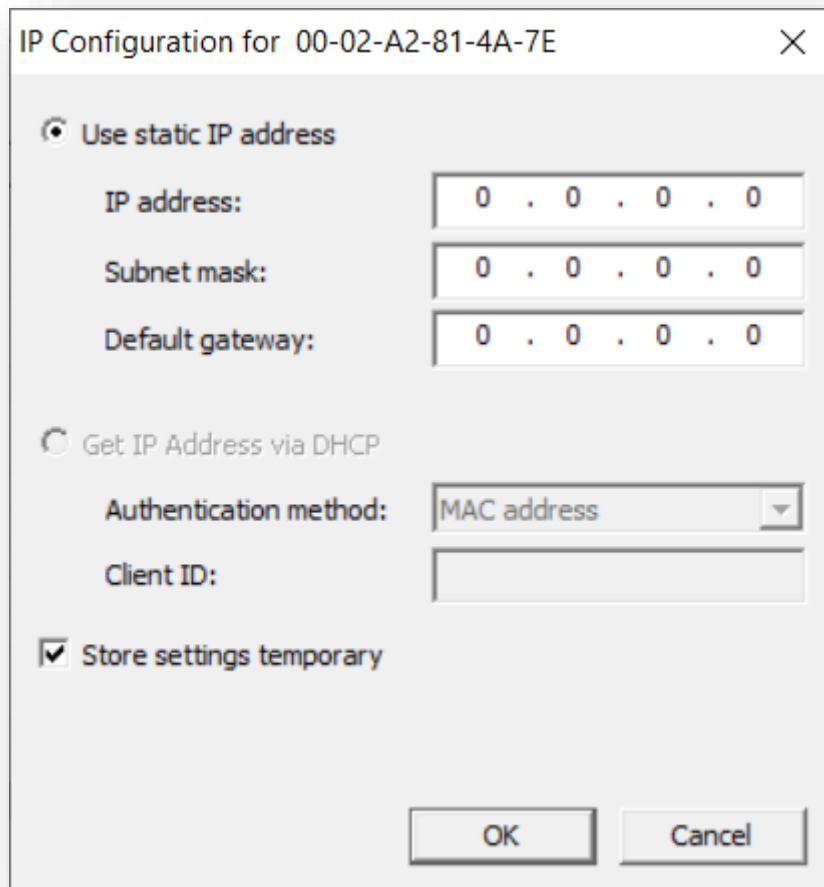

IP Configuration for 00-02-A2-81-4A-7E

Use static IP address

IP address: 0 . 0 . 0 . 0

Subnet mask: 0 . 0 . 0 . 0

Default gateway: 0 . 0 . 0 . 0

Get IP Address via DHCP

Authentication method: MAC address

Client ID:

Store settings temporary

OK Cancel

7. enter the desired IP address and set the subnet mask to 255.255.255.0

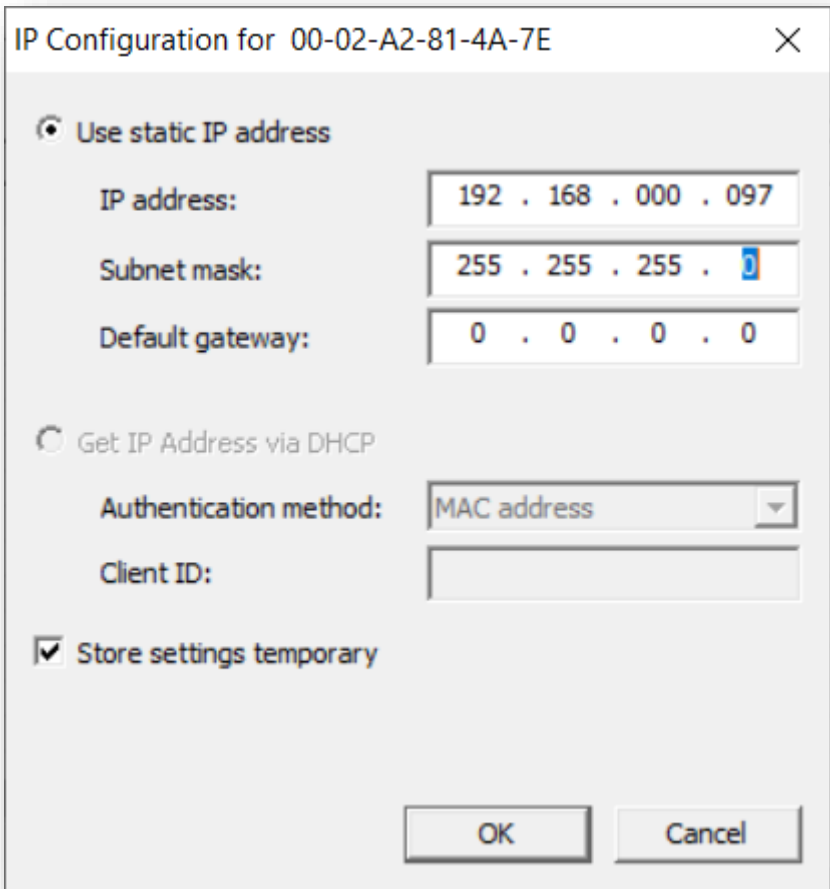

8. Press OK to store the changes

10 Dimensions

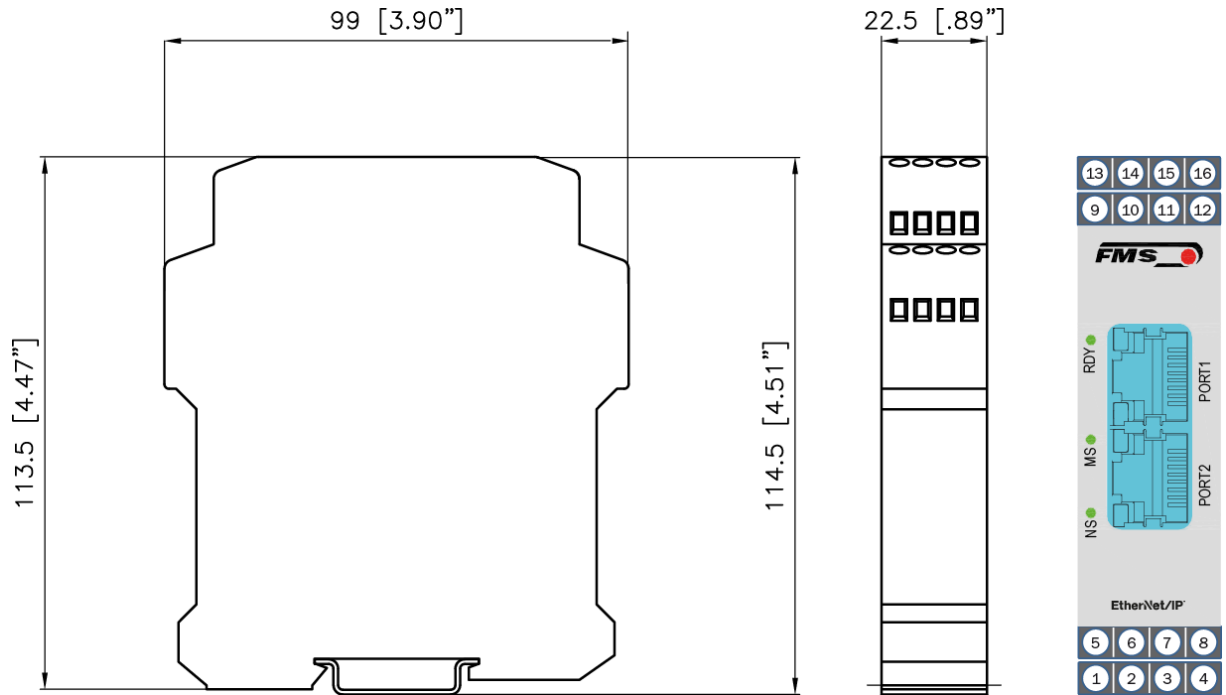

Figure 9: EMGZ491.R.EIP housing for DIN rail mounting

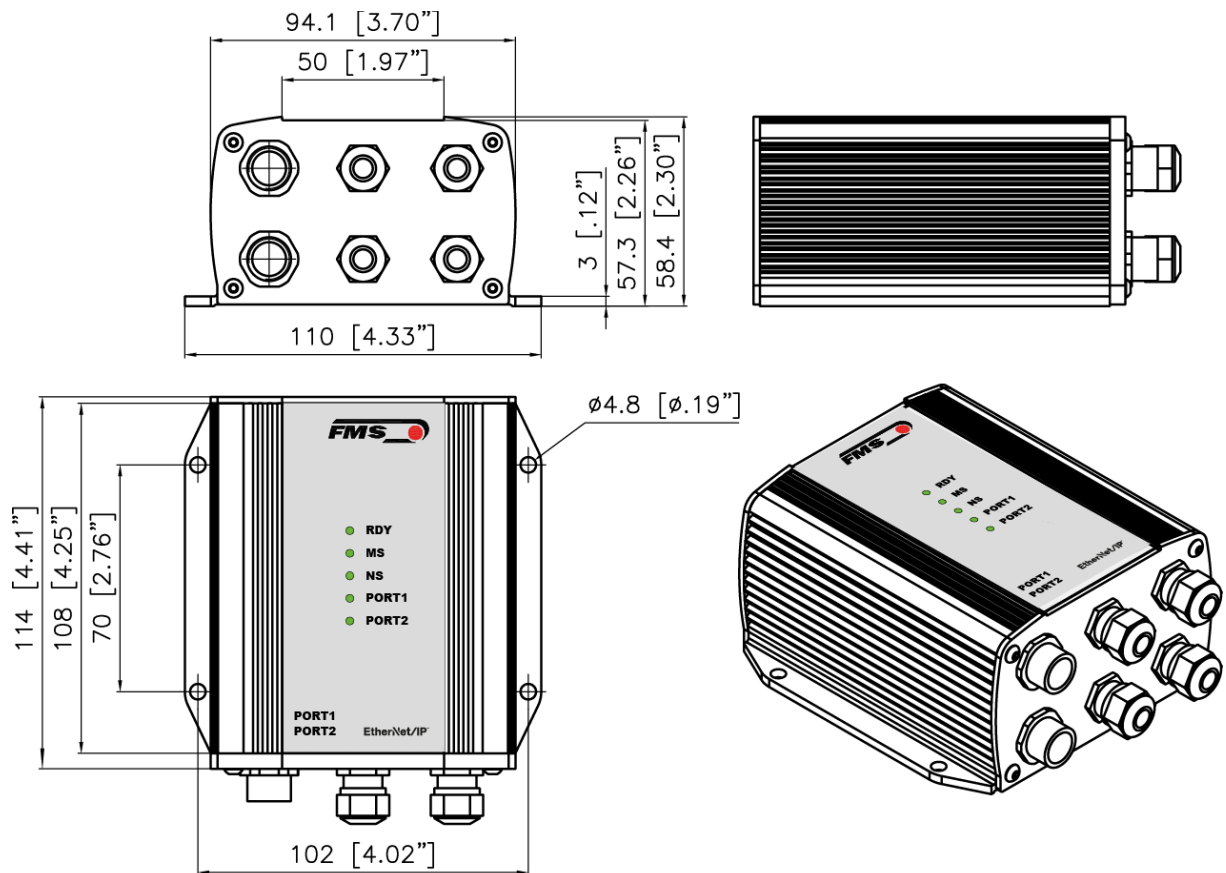

Figure 10: EMGZ491.W.EIP housing for wall mounting

11 Technical Data

Technical data	
Number of channels	1 channel for 2 sensors
Excitation voltage	5 VDC
Sensor feedback signal	± 9 mV (max. 12.5 mV) Option V05 ± 2.5 mV
A/D converter resolution	± 32'768 digit (16 bit)
D/A converter resolution	0 to 4'096 (12 bit)
Measuring inaccuracy	< 0.05 % FS
Connector for interface	EMGZ 491.R: 2 x RJ-45 EMGZ 491.W: 2 x M 12 4-pole, D-coded
Configuration	via ETHERNET/IP or web server
Protection class	IP20 (.R version) IP65 (.W version)
Power supply	24 VDC (18 to 36 VDC)
Power consumption	5 W
Temperature range	-10 to +50 °C (14 to 122 °F)
Weight	370 g / 0.82 lbs (.R version); 470 g / 1.04 lbs (.W version)

EtherNet/IP characteristics	
Cycle time	≥ 1 ms
IO Connection Types (implicit)	Exclusive Owner; Listen Only; Input only
Number of Message Connections	Explicit message connections (10); Implizit message connections (5)
IO Connection Trigger Types	Cyclic
Baud Rate	10 or 100 Mbit/s
Cyclic Process Data	Actual value in Digits (ADC); Actual value in Newton; Istwert in Pfund; actual value in config. unit, Status
Acyclic Services	Get_Attribute_Single; Set_Attribute_Single; according to CIP spezification Volume 1 and Volume 2;...
Ring Topology	DLR (Device Level Ring)
Predefined Standard Objects	Identity Object; Message Router Object; Assembly Object; Connection Manager; DLR Object; QoS Object; TCP/IP Interface Object; Ethernet Link Object
Features	DLR (Device Level Ring), beacon based ring node; ACD (Address Conflict Detection); DHCP, BOOTP; Integrated Switch
Web interface	Configuration, measuring data queries via http (alternative configuration via EtherNet/IP)
Certification	according CT15



FMS Force Measuring Systems AG
Aspstrasse 6
8154 Oberglatt (Switzerland)
Tel. +41 44 852 80 80
info@fms-technology.com
www.fms-technology.com

FMS USA, Inc.
2155 Stonington Avenue Suite 119
Hoffman Estates,, IL 60169 (USA)
Tel. +1 847 519 4400
fmsusa@fms-technology.com