



Operating Instructions

EMGZ310

Compact digital measuring amplifier

EMGZ310.ComACT

Digital Tension Measuring Amplifier with Optional Operation
via FMS-comACT App

Document version	2.40	02/2022 NS
Firmware EMGZ310	V 1.14	
Firmware EMGZ310.ComACT	V2.10	



EMGZ310.R



EMGZ310.R.ComACT
EMGZ310.W.ComACT

Diese Bedienungsanleitung ist auch in Deutsch erhältlich.

Bitte kontaktieren Sie Ihre lokale FMS Vertretung.

1 Table of Contents

1	TABLE OF CONTENTS	2
2	SAFETY INFORMATION	3
2.1	Presentation of Safety Information.....	3
2.1.1	Danger that Could Result in Minor or Moderate Injuries	3
2.1.2	Note Regarding Proper Function	3
2.2	General Safety Information	4
2.3	Regulatory Notices	4
2.4	Notes Réglementaires.....	6
3	PRODUCT DESCRIPTION	7
3.1	Block Diagram.....	7
3.2	Product Description.....	7
3.3	Scope of Delivery	7
4	QUICK GUIDE/QUICK START	8
4.1	Preparations for Parameterization	8
4.2	Mounting Sequence	8
4.3	Installation and Electrical Connections	8
4.4	Force sensor installation	9
4.5	Electrical Connections housing type .R	9
4.6	Electrical connections housing type .W	10
5	OPERATION AND CONFIGURATION	14
5.1	Power up the EMGZ 310.....	14
5.2	Operating panel and controls.....	14
5.3	Reset to factory settings.....	15
6	CALIBRATION OF THE MEASURING SYSTEM.....	16
6.1	Offset Compensation	16
6.2	Calibration (Adjusting the Gain Factor).....	16
6.2.1	Calibrating in force mode.....	17
6.2.2	Calibrating in voltage mode	17
7	PARAMETER LIST	19
8	FMS COMACT APP™	22
8.1	Configuration via the App.....	22
8.2	Data recording.....	23
9	DIMENSIONS	26
10	TECHNICAL DATA.....	28

2 Safety Information

All safety information, operating and installation regulations listed here ensure proper function of the device. Safe operation of the systems requires compliance at all times. Noncompliance with the safety information or using the device outside of the specified performance data can endanger the safety and health of persons.

Work with respect to operation, maintenance, retrofit, repair, or setting the device described here must only be performed by expert personnel.

2.1 Presentation of Safety Information

2.1.1 Danger that Could Result in Minor or Moderate Injuries



Danger, warning, caution

Type of danger and its source

Possible consequences of nonobservance

Measure for danger prevention

2.1.2 Note Regarding Proper Function



Note

Note regarding proper operation

Simplification of operation

Ensuring function

2.2 General Safety Information



The function of the measuring amplifier is only ensured with the components in the specified layout to one another. Otherwise, severe malfunctions may occur. Thus, observe the mounting information on the following pages.



Observe the local installation regulations.



Improper handling of the electronics module can lead to damage to the sensitive electronics!

Do not work with a blunt tool (screw driver, pliers, etc.) on the housing!

Use suitable grounding (grounding wrist strap, etc.) when working on the electronics.



The devices should have a distance of at least 15 mm to one another in the control cabinet for proper cooling.

2.3 Regulatory Notices

NOTE:

This device complies with Part 15 of the FCC Rules and with Industry Canada licence-exempt RSS standard(s).

Operation is subject to the following two conditions:

- this device may not cause harmful interference, and
- this device must accept any interference received, including interference that may cause undesired operation.

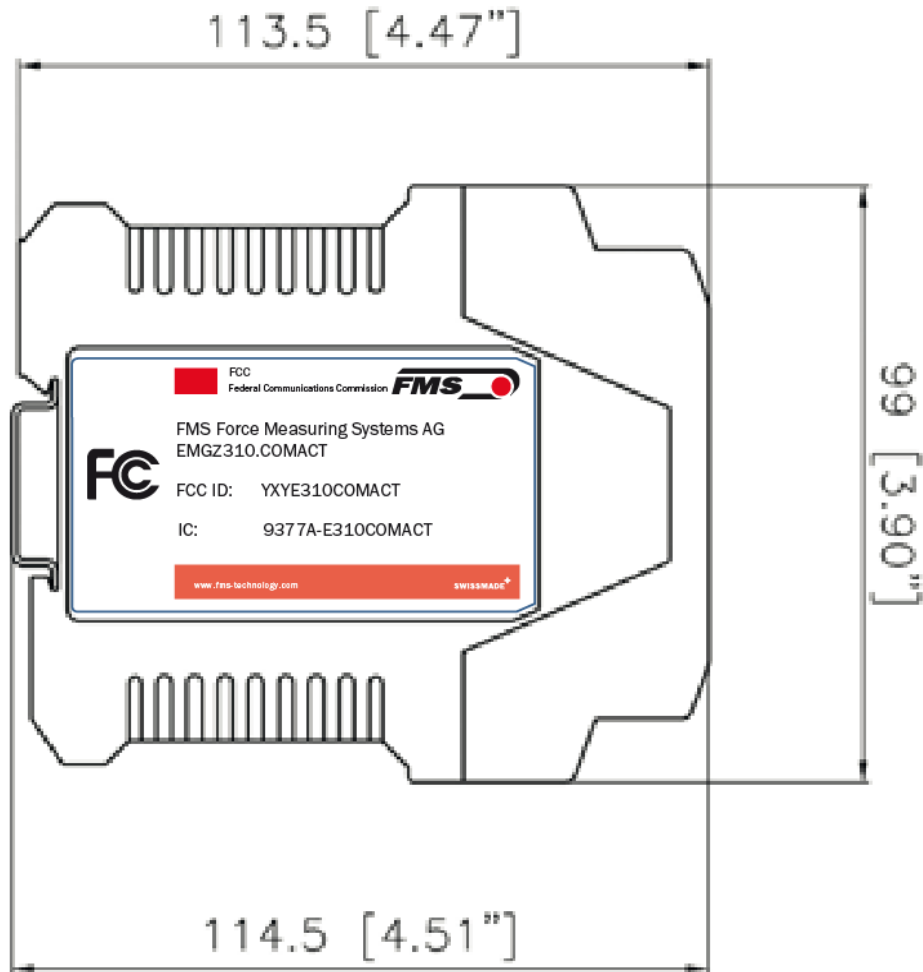

Figure 1: FCC Labeling on device

FCC_Label_EMGZ310ComACT..ai

NOTE:

This equipment has been tested and found to comply with the limits for a Class A digital device, pursuant to Part 15 of the FCC Rules. These limits are designed to provide reasonable protection against harmful interference when the equipment is operated in a commercial environment. This equipment generates, uses, and can radiate radio frequency energy and, if not installed and used in accordance with the instruction manual, may cause harmful interference to radio communications. Operation of this equipment in a residential area is likely to cause harmful interference in which case the user will be required to correct the interference at his own expense.+

NOTE:

Changes or modifications made to this equipment not expressly approved by FMS Force Measuring Systems AG may void the FCC authorization to operate this equipment.

Radiofrequency radiation exposure Information:

This equipment complies with FCC and IC radiation exposure limits set forth for an uncontrolled environment. This equipment should be installed and operated with minimum distance of [50] cm between the radiator and your body.

This transmitter must not be co-located or operating in conjunction with any other antenna or transmitter.

2.4 Notes Réglementaires

NOTE:

Cet équipement est conforme à la section 15 du règlement de la Commission fédérale américaine des communications (FCC) et au(x) Cahier(s) des charges sur les normes radioélectriques (CNR) d'Industrie Canada exemptes de licence.

Son utilisation est soumise aux deux conditions ci-dessous :

- cet équipement ne peut pas causer d'interférences nuisibles, et
- cet équipement doit accepter toutes les interférences, y compris celles qui pourraient provoquer un fonctionnement indésirable.

NOTE:

Cet équipement a été testé et déclaré conforme aux limites applicables aux appareils numériques de classe A, selon la section 15 du règlement FCC. Ces limites visent à garantir une protection raisonnable contre les interférences nuisibles lorsque l'équipement est utilisé dans un environnement commercial.

Cet équipement produit, utilise et peut émettre une énergie de fréquence radio et, s'il n'est pas installé ni utilisé conformément au manuel d'instruction, il peut générer des interférences affectant les communications radio. L'utilisation de cet équipement dans une zone résidentielle peut causer des interférences nuisibles, auquel cas l'utilisateur sera tenu d'y remédier à ses frais.

NOTE:

Des changements ou modifications apportés à cet équipement sans l'autorisation expresse de FMS Force Measuring Systems AG peuvent invalider l'agrément d'utilisation de cet équipement accordé par la FCC.

Informations sur l'exposition aux rayonnements radioélectriques

Cet équipement est conforme aux limites d'exposition aux rayonnements IC établies pour un environnement non contrôlé. Cet équipement doit être installé et utilisé avec un minimum de

[50] cm de distance entre la source de rayonnement et votre corps.

Ce transmetteur ne doit pas être placé au même endroit ou utilisé simultanément avec un autre transmetteur ou antenne. “

3 Product Description

3.1 Block Diagram

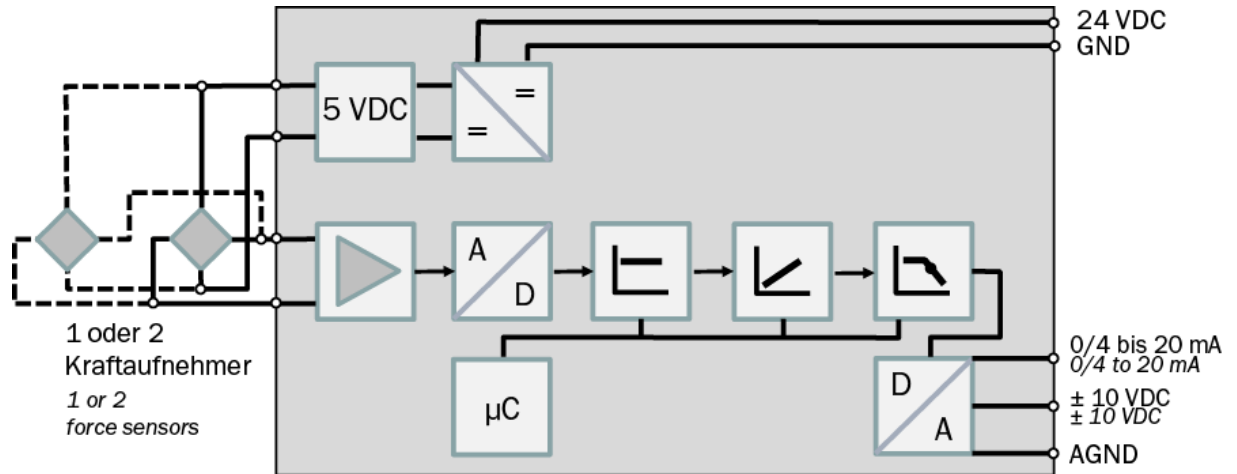

Figure 2: block diagram EMGZ310

EMGZ310_BA_Manual.ai

3.2 Product Description

The digital tension measuring amplifier EMGZ310.ComACT is suitable for tension measurement with all FMS force sensors. This versatile product includes the latest technology and can substitute for all single channel amplifiers (1 measuring point, 1 or 2 force sensors). Amplifier configuration is straightforward with the parameters being set using either three easily accessible keys or your smartphone/tablet. The free FMS-ComACT app is available for download for IOS and Android devices, and makes parameter setting and value reading as efficient and comfortable as never before.

3.3 Scope of Delivery

The following is included in the scope of delivery

- Measuring amplifier

The following is not included in the scope of delivery

- AC/DC power supply, minimum requirement: EMC immunity specifications EN61000-4-2, 3, 4, 5; EN55024 light industry level, criteria A, e.g., TRAKO TXL 035-0524D
- Cable for power supply

The following is not included in the scope of delivery, but are available as accessories from FMS

- Sensor cable for the connection of force sensor and measuring amplifier

4 Quick Guide/Quick Start

In these operating instructions, commissioning of the measuring amplifier is limited to the description of the installation procedure, offset compensation, and system calibration.

4.1 Preparations for Parameterization

- Read the operating instructions of the selected force sensor carefully.
- Check your requirements on the system, such as:
 - o Used units in the system
 - o Used outputs (current or power)
- Filter settings for actual force value and analog output
- Create the connection diagram for your specific system layout (see chapter "Electrical Connection")

4.2 Mounting Sequence

- Mount the force sensors (mounting details can be obtained from the mounting instructions of the force sensors)
- Connect the force sensors to the amplifier
- Connect the amplifier to the supply voltage. The voltage supply must be in the range of 18 to 36 VDC
- Perform offset compensation and calibration
- Change the parameter settings as needed

4.3 Installation and Electrical Connections

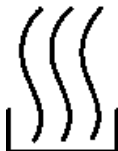

Warning

To improve natural convection and keep heating of the amplifiers as low as possible, the devices installed in a cabinet should have a minimum distance of 15 mm.



Warning

The function of the measuring amplifier is only ensured with the components in the specified layout to one another. Otherwise, severe malfunctions may occur. Thus, the mounting information on the following pages must be followed



Warning

The local installation regulations ensure the safety of electrical systems. They are not considered in these operating instructions. However, they must be met.

4.4 Force sensor installation

The force sensors are mounted in line with the mounting instructions of the respective products. The mounting instructions are included with the force sensors.

4.5 Electrical Connections housing type .R

One or two force sensors can be connected to the amplifier. When two sensors are used, they are connected in parallel internally. The force sensors and amplifier are connected using a 2 x 2 x 0.25 mm² [AWG 23] shielded, twisted cable.



Figure 3: electrical connections

EMGZ310_BA_Manual.ai

For easy installation, the terminal blocks can be removed from the main body



Figure 4: Detachable terminal blocks: use a small slotted screwdriver as a lever

4.6 Electrical connections housing type .W

One or two force sensors can be connected to the amplifier. When two sensors are used, they are connected in parallel internally. The force sensors and amplifier are connected using a 2 x 2 x 0.25 mm² [AWG 23] shielded, twisted cable.

- Loosen the 4 countersunk screws on the housing cover.
- Remove the screws and put them aside. Please store well
- You will find notches on the side of the cover. Insert a flat screwdriver and use it to carefully pry off the cover.
- Carefully pull the cover off upwards.

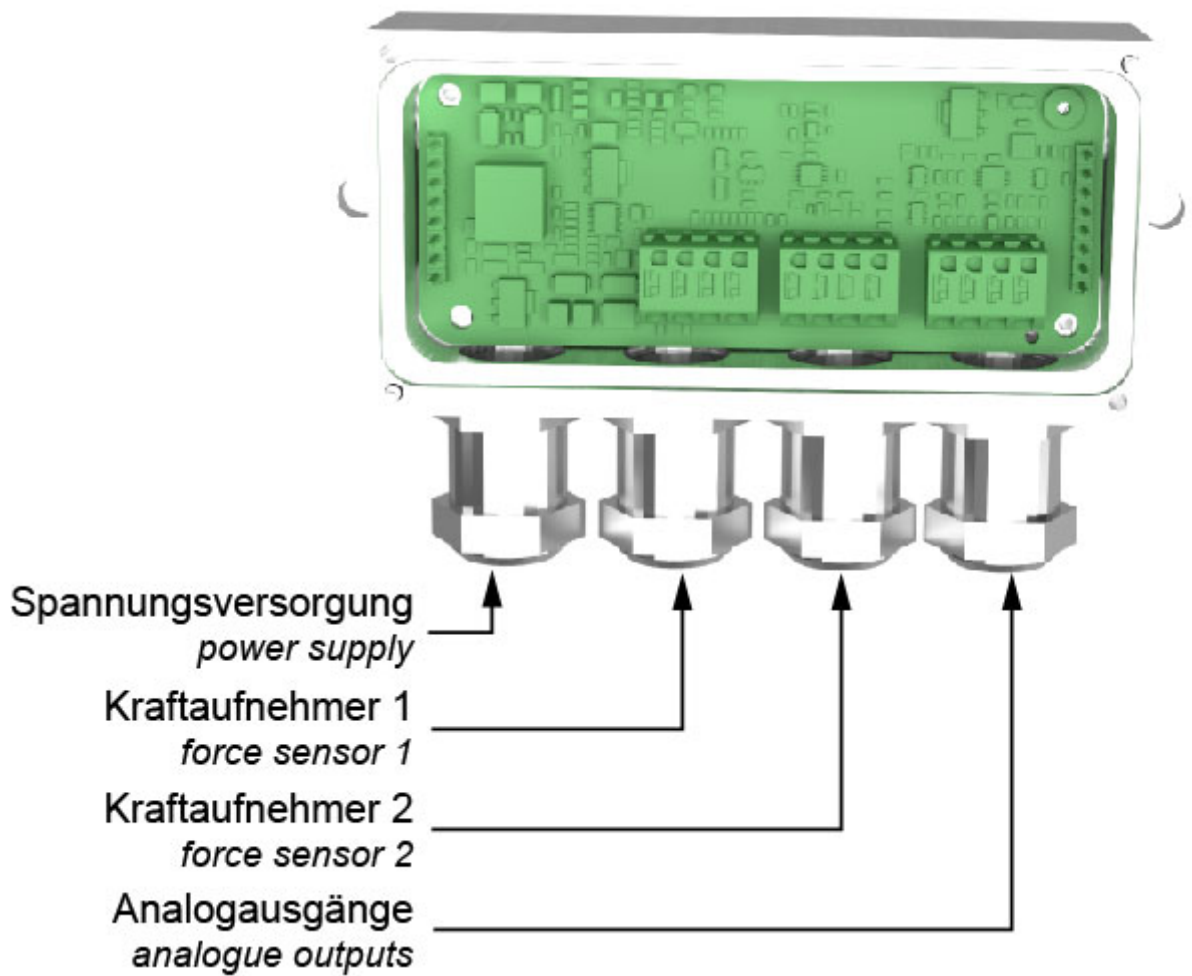

Figure 5: recommended wiring through the pg-glands EMGZ310_BA_Manual.ai

First lead the stranded wires upwards, past the terminals and insert them into the terminal blocks from above.

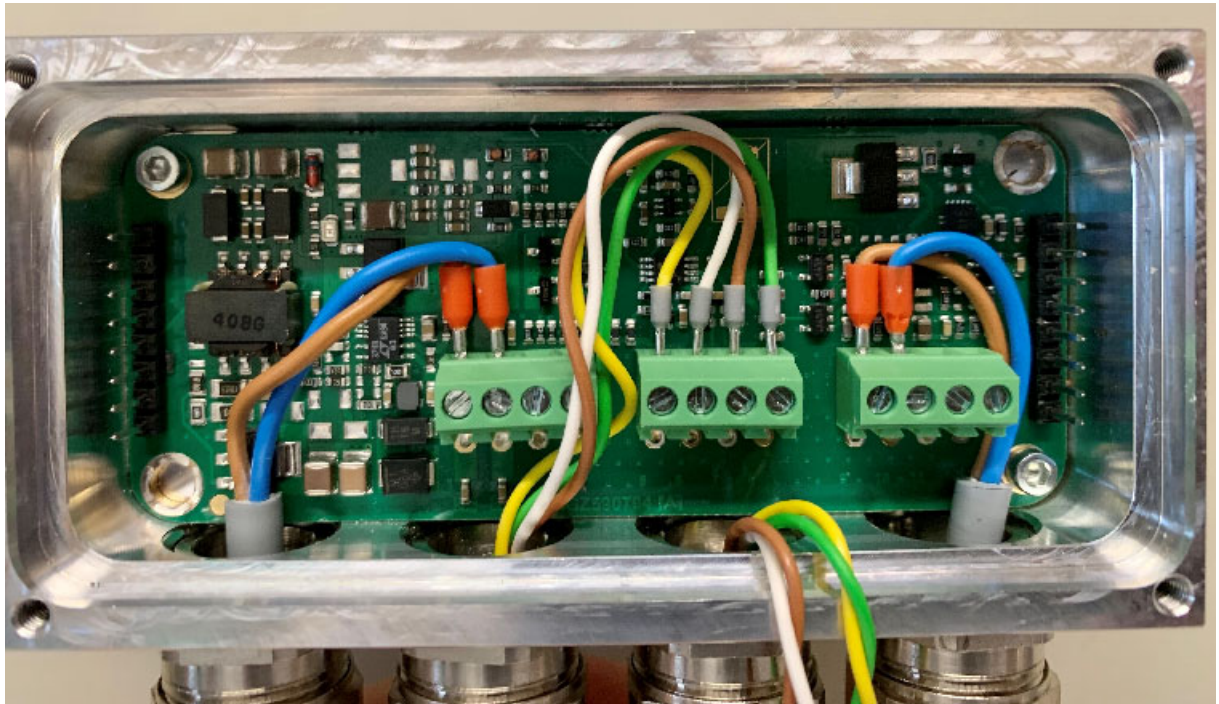

Figure 6: recommended wiring

EMGZ310_BA_Manual.ai

Power Supply		Load Cell		Analog Output	
1	24 VDC	5	+ Excitation	9	± 10 V
2	GND	6	+ Signal	10	GND
3	PE	7	- Signal	11	0/4 to 20 mA
4	Shield	8	- Excitation	12	Shield

Figure 7: electrical connections

EMGZ310_BA_Manual.ai



Poor grounding can result in electric shocks for persons, malfunctions of the overall system or damage to the measuring amplifier! Proper grounding must always be ensured.



Note

Cable shielding may only be connected to one side of the measuring amplifier. On the side of the force sensor, shielding must remain open.

5 Operation and configuration

5.1 Power up the EMGZ 310

- Connect the first force sensor
- Check whether applying a force in measuring direction (in the direction of the red point) on the first sensor results in a positive output signal. If not, swap the two signal wires of this force sensor
- If applicable, connect the second force sensor. Check whether applying a force in measuring direction on the second sensor results in a positive output signal. If not, swap the two signal lines of this force sensor.

5.2 Operating panel and controls

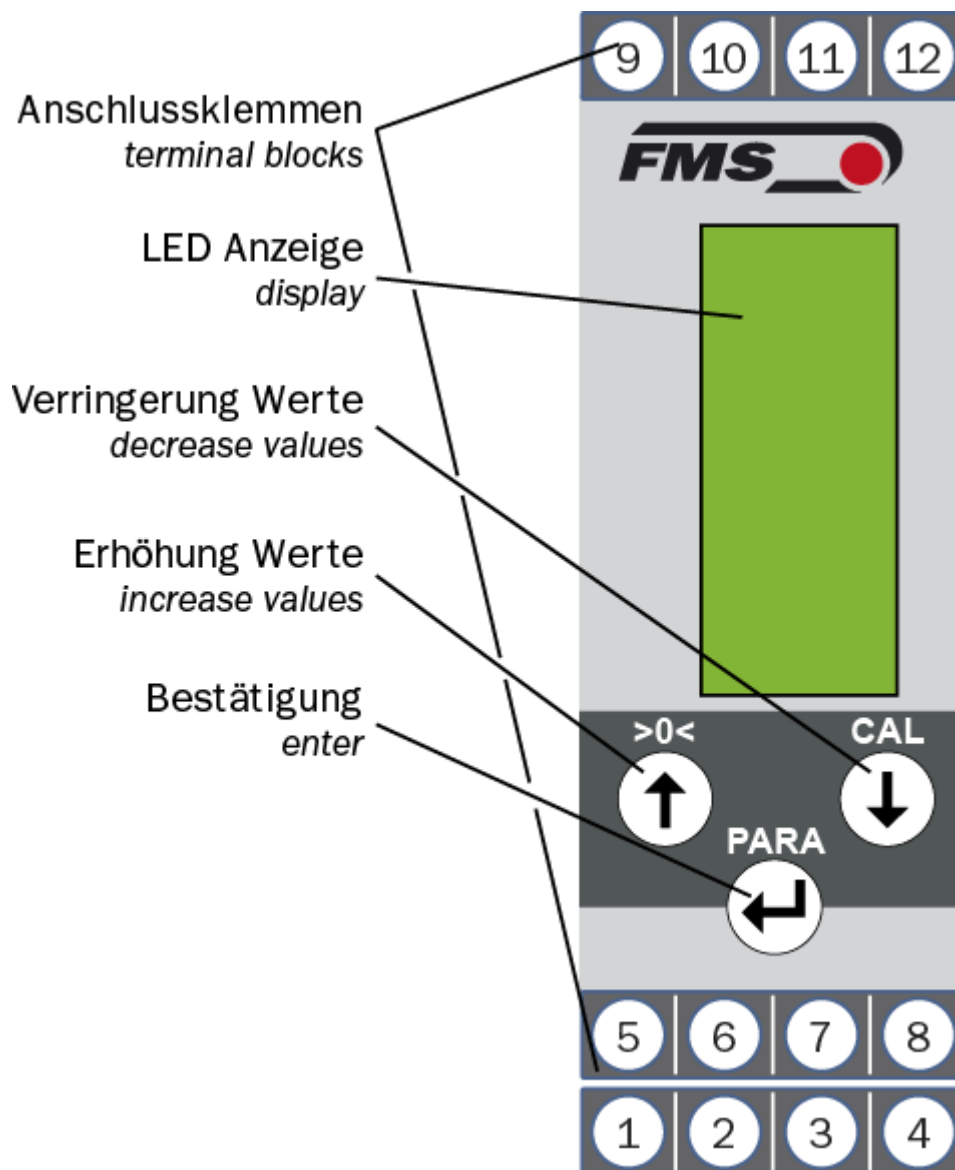

Figure 8: front view version .R

EMGZ310_BA_Manual.ai

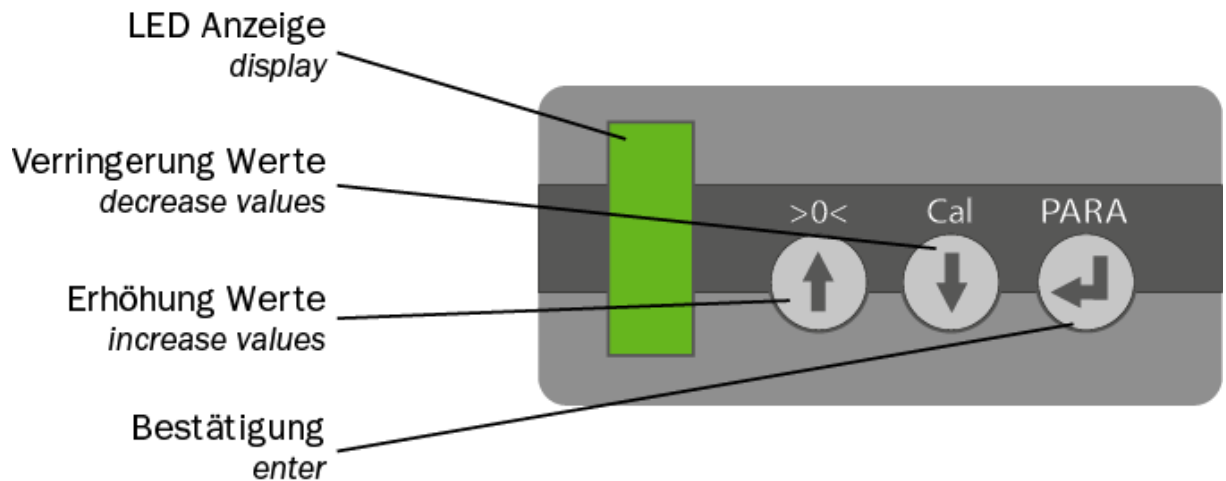

Figure 9: front view version .W

EMGZ310_BA_Manual.ai

Controls	
Button	Description
	Change the selections, increase / decrease the values or choose Scroll up or down the parameter lists
	Enter
>0< + PARA	> 3 Sec. Start Offset compensation procedure
CAL + PARA	> 3 Sec. Start calibration procedure
PARA	> 3 Sec. Parameter setting

Table 1: controls

5.3 Reset to factory settings

Disconnect the device from the power supply.

Re-establish power supply and press both arrow keys



. Hold the keys for min. 3 sec. while the device reboots.

6 Calibration of the Measuring System

6.1 Offset Compensation

Using offset compensation, the weight of the measuring roller is compensated and the measuring system “zeroed”.

Offset compensation must always be executed prior to the actual calibration. The measuring roller must not be loaded during the procedure.

- Press and hold the two buttons  +  (>0< + PARA) at the same time for longer than 3 seconds. The value for offset compensation is calculated automatically and stored in the amplifier.

6.2 Calibration (Adjusting the Gain Factor)

Calibration is used for matching the gain factor with the force sensors. After calibration, the displayed force corresponds the effective material tension of the web / filament. Two calibration methods are possible. The first calibration method described here uses a defined weight. There is also a calculation method for the gain factor. The weight-based calibration method is simple and delivers more accurate results as it replicates the material profile (see the figure below) and considers the actual circumstances in the machine.

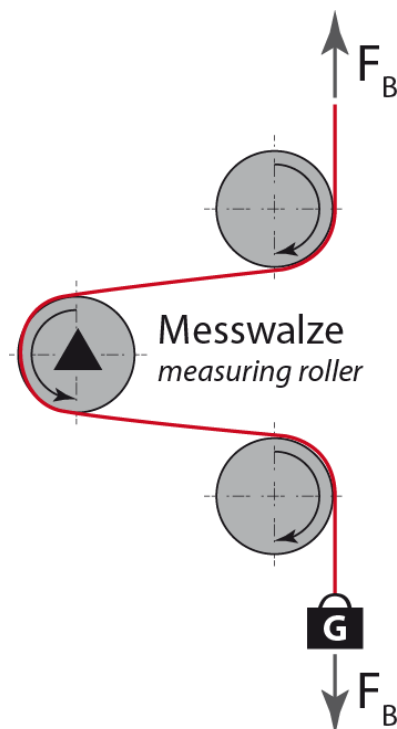













Figure 10: Simulation of the material profile using a defined weight
Tension_Control_Solutions.ai

6.2.1 Calibrating in force mode



Note

If there is no input during 30 sec. while you perform the calibration procedure, the display will automatically switch back to the initial screen without saving the previous inputs.



- Insert a rope into the machine. Simulate the exact web path in the machine.
- Load the rope with a defined weight
- Press and hold the two buttons  +  (CAL + PARA) at the same time for longer than 3 seconds.
- Enter the system force (Sys_F). The system force is made up of the nominal force of the connected force sensors. If e.g. two force sensors with a nominal force of 500 N each are connected, the system force is $2 \times 500 \text{ N} = 1000 \text{ N}$. The nominal force of FMS force sensors is indicated on the type label.
- You can modify the value with  .
- Save the changes with .
- Enter the weight (GAIN) connected to the rope. Pay attention to the selected unit. 10 kg would require an input of 100 N if the system is set to N.
- You can modify the value with  .
- Save the changes with .
- The parameter F@mOut set the value of the indicated tension with maximum output (10 VDC or 20 mA) on the display of the amplifier.
- You can modify the value with  .
- Save the changes with .
- The display will return to the main screen
- The calibration procedure is complete



6.2.2 Calibrating in voltage mode



Note

If there is no input during 30 sec. while you perform the calibration procedure, the display will automatically switch back to the initial screen without saving the previous inputs.

- Insert a rope into the machine. Simulate the exact web path in the machine.
- Load the rope with a defined weight
- Press and hold the two buttons  +  (CAL + PARA) at the same time for longer than 3 seconds.
- Enter the weight (GAIN) connected to the rope. Pay attention as the unit is set to volt.

- Modify the value with   until the voltage output correlates with the weight.
- Save the changes with 
- The display will return to the main screen
- The calibration procedure is complete

7 Parameter list

Parameter	
Name	Description
Output	<p>This parameter determines the current output signal of the amplifier. The voltage output (± 10 V) is also available in parallel</p> <p>Selection 0 to 20 mA; 4 to 20 mA</p> <p>Default 4 to 20 mA</p>
Filter	<p>The amplifier provides a low-pass filter to prevent noise overlaying the output signal. The parameter Filter stores the cut off frequency of the filter. The lower the cut off frequency, the more sluggish will the output as well as the display be. The filter stabilizes the output signal in case of highly fluctuating tension values. A correctly tuned filter will "straighten" the displayed value.</p> <p>Unit Hz</p> <p>Min. 0,1</p> <p>Max. 999,9</p> <p>Default 10,0</p>
Unit	<p>This parameter determines the unit used in the system. The label on the force sensor shows always the nominal force in N.</p> <p>NOTE: By changing the unit to lb (pounds) the entire system will change from metric to imperial units.</p> <p>NOTE: If the system is set to voltage mode [VoltGauge], this parameter is disabled</p> <p>Selection N; kN; lb; g; kg</p> <p>Default N</p>

<p>Sys_F</p>	<p>The system force indicates which measuring force capacity is installed in the measuring roller. E.g., if two 500 N force sensors are installed in the roller, 1'000 N must be entered. In the case of a one-sided measurement, hence is one 500 N force sensor is used, 500 N must be entered. If force measuring rollers with pulleys are used (e.g., RMGZ series), the nominal force of the force measuring roller must be specified (in the example 500 N as well)</p> <p>NOTE: For force values larger than the available 9'999 please change the unit. E.g. for a system force of 12'000N change the unit to kN and enter 12kN as system force.</p> <p>NOTE: If the system is set to voltage mode [VoltGauge], this parameter is disabled</p> <p>Unit N; kN; lb; g; kg (selected in "unit")</p> <p>Min. 1</p> <p>Max. 9999</p> <p>Default 1000</p>
<p>F@mOut</p>	<p>This parameter determines the tension value (N, kN, lb, g, kg) that is indicated at the maximum output of the amplifier (10 V or 20mA).</p> <p>NOTE: If lb (pound) is selected, the system switches from metric to imperial measuring units.</p> <p>Selection N; kN; lb; g; kg (selected in "unit")</p> <p>Min. 1</p> <p>Max. 100000</p> <p>Default 1000</p>
<p>Offset</p>	<p>The values determined with the "Offset Compensation" procedure are stored in the form of a digital value in this parameter. The value is used for compensating for the roller weight.</p> <p>Min. -9999</p> <p>Max. 9999</p> <p>Default 0</p>
<p>Gain</p>	<p>The values determined with the "Calibration" procedure are stored in the form of a digital value in this parameter.</p> <p>Min. 0.001</p> <p>Max. 20.000</p> <p>Specified value 1.000</p>

Mode	<p>The Device Mode determines the functionality of the amplifier. If set to Volt Gauge, force values will be displayed only in Volt (V) or mA. Force units will not be available anymore.</p> <p>Selection kgkNN; V</p> <p>Default kgkNN</p>
-------------	--

8 FMS ComACT App™

If you have purchased an EMGZ310.ComACT measuring amplifier you are able to display actual readings and configure the amplifier via the FMS-ComACT app.

You can identify the type of amp on the type label. The EMGZ310.ComACT has also the last 4 digits of its serial number printed on the front housing.

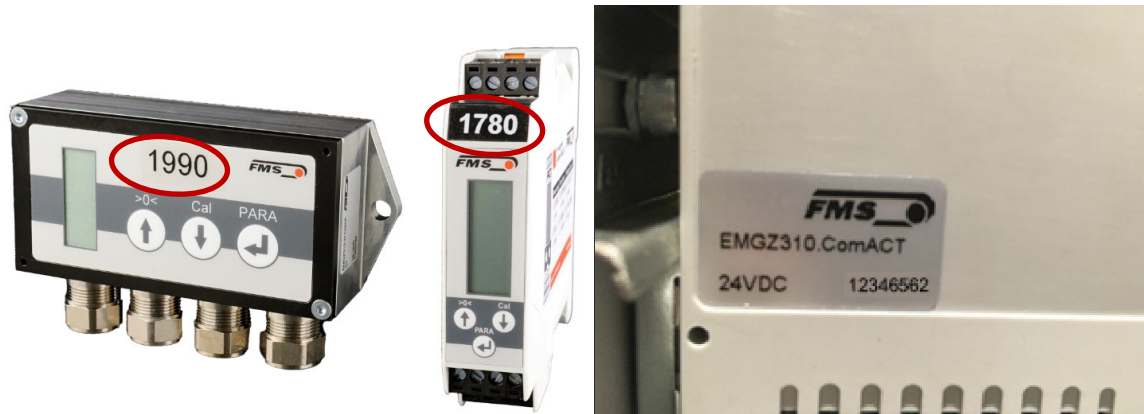

Figure 11: EMGZ310.ComACT.R with serial number *EMGZ310_Typenschild.jpg*

Only a single mobile device at a time can connect to an amplifier.

As soon as the connection between amp and mobile device is setup, the display of the amp will start flashing.

The FMS-ComACT app is meant as an operation aid to display actual readings and to help configure the amplifier. The settings are only stored in the amplifier and not in the mobile device.

8.1 Configuration via the App

The procedures of offset compensation and calibration are always identical to an amplifier without Bluetooth connectivity. Instead of using the operating panel of the amplifier, you can use here any mobile device for input and configuration.

<p>Download FMS ComACT™ app → Google Play</p>	<p>Overview with all amplifiers within the transmitting</p>	<p>Display of actual readings with the selected settings (unit, gain, output,</p>	<p>“Configure” requires a password. The password is</p>

Store (Android); iTunes (IOS)	range.	etc.) Input signal from force sensors Start record	preset to “3231” and it cannot be modified.
-------------------------------	--------	--	---

„Calibration“ leads you to the offset and gain menu. Button for the export of the parameter settings	You can perform an offset without any further input. Make sure that there is no web applied to the roller.	Successful input and operations are confirmed	Before you perform the calibration, you have to enter the value for the corresponding force that you have applied to the measuring roller.

Table 2: Screenshots App (Android) - configuration



Export of parameter settings

The export will create a .txt file that you can send via any channel or store as required.

This can be of help to document the settings.

8.2 Data recording

Measurement data lengths can be recorded with different interval. The data is stored in .csv format and can be sent from your mobile device via the most common channels. For evaluation you can use any spreadsheet program.

- For measurement, your mobile device must be connected to the measuring amplifier at all times.

<p>Start recording</p>	<p>Selection of the interval and resolution (measuring values per second)</p>	<p>Recording in progress with remaining time and actual reading</p> <p>You can determine the recording at all time. Recorded data will remain available for the export.</p>	<p>End of a measurement. Measurement time expired.</p> <p>Button "Export" for further use of the measurement data.</p>
<p>Transmission of measurement data via any channel/service, e.g. SMS,...</p>	<p>..., Email, Whatsapp,...</p>	<p>..., Skype, Dropbox, etc.</p>	<p>E.g. termination of a measurement after a few seconds</p>

Table 3: Screenshots App (Android) - record

The name of the export .csv file contains the following information

FMS EMGZ310.ComACT_4969_2020-3-24_Dienstag_162010.csv

Tag_Uhrzeit beim Start der Messung HHMMSS <i>day_record starting time HHMMSS</i>
Datum YYYY-M-TT <i>date YYYY-M-DD</i>
Letzte 4 Zahlen der Seriennummer <i>last 4 digits of serial number</i>

Figure 12: file name



Note

In each export file, you will find the parameter settings of the amplifier.

This can be of help to document the settings.

9 Dimensions

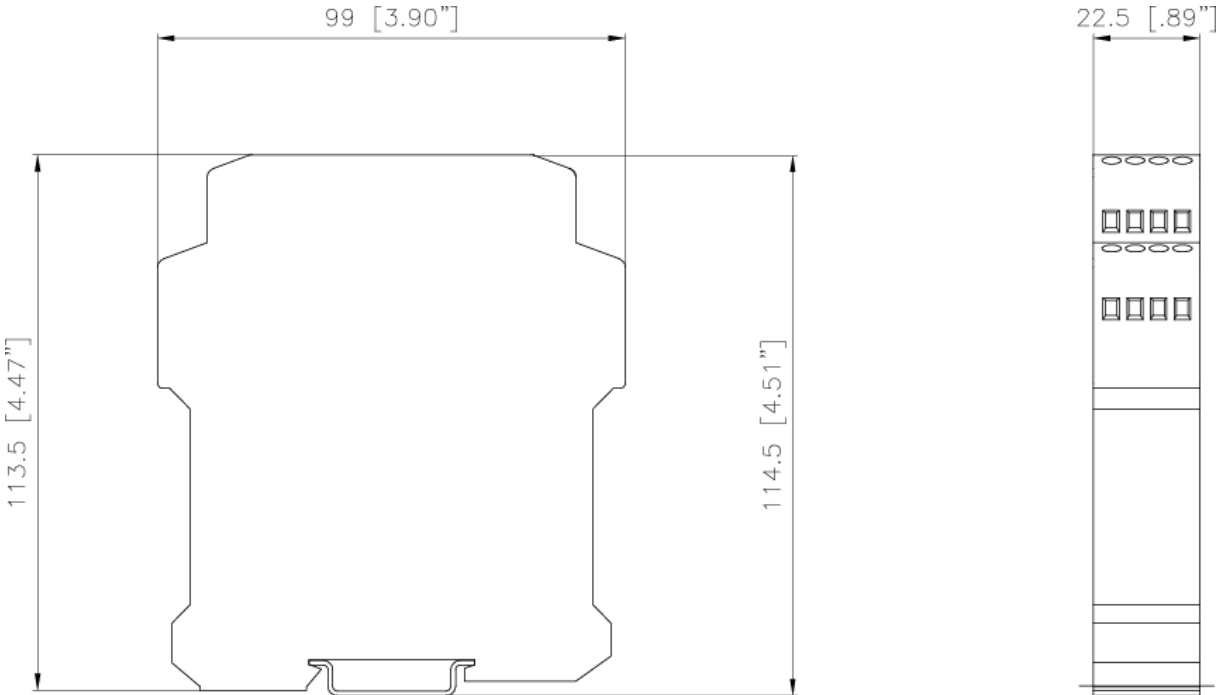

Figure 13: dimensions housing type .R

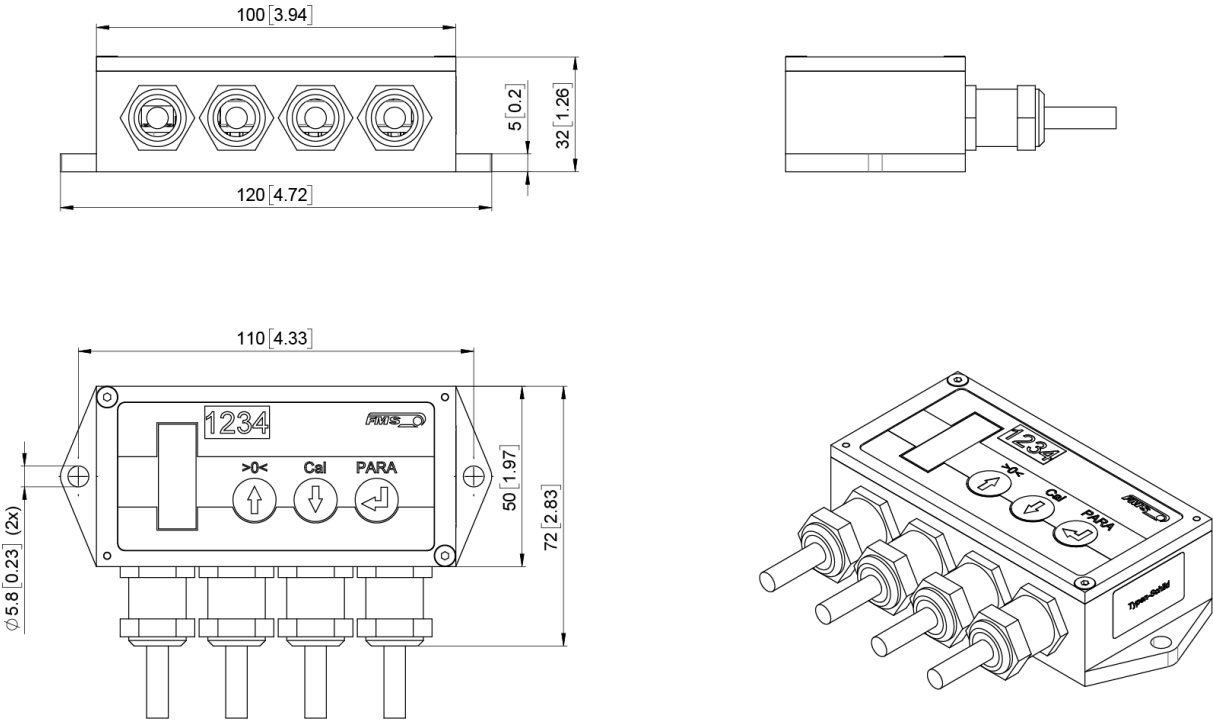

Figure 14: dimensions housing type .W

10 Technical Data

Technical data	
Number of channels	1 channel, for max. 2 force sensors
Excitation voltage	5 VDC
Sensor feedback signal	± 9 mV Option V05: ± 2.5 mV
Resolution A/D converter	± 10'000 Digit (14 Bit)
Configuration	3 keys and display of the values via integrated LCD optional via FMS-ComACT app on your smartphone or tablet.
Protection class	Housing type .R IP 20 Housing type .W IP 65
Power supply	24 VDC (18 to 36 VDC)
Power consumption	5 W
Temperature range	-10 to +50 °C (14 to 122 °F)
Weight	370 g / 0.82 lbs



FMS Force Measuring Systems AG
 Aspstrasse 6
 8154 Oberglatt (Switzerland)
 Tel. +41 44 852 80 80
 Fax +41 44 850 60 06
 info@fms-technology.com
 www.fms-technology.com

FMS USA, Inc.
 2155 Stonington Avenue Suite 119
 Hoffman Estates., IL 60169 (USA)
 Tel. +1 847 519 4400
 Fax +1 847 519 4401
 fmsusa@fms-technology.com

FMS (UK)
 Aspstrasse 6
 8154 Oberglatt (Switzerland)
 Tel. +44 1767 221 303
 fmsuk@fms-technology.com

FMS (Italy)
 Aspstrasse 6
 8154 Oberglatt (Switzerland)
 Tel. +39 02 39487035
 fmsit@fms-technology.com