



Operating Manual EMGZ307

Analogue Tension Measuring Amplifier

Version 1.1 10/2009 ff

This operation manual is also available in German, French and Italian.
Please contact your local representative.

Diese Bedienungsanleitung ist auch in Deutsch, Französisch und Italienisch erhältlich.
Bitte kontaktieren Sie Ihren nächstgelegenen FMS Vertreter.

Ce mode d'emploi est également disponible en Français, en Italien et en Allemand.
Veuillez contacter la représentation locale.

Queste manuale d'installazione è disponibile anche in lingua italiana, francese e tedesco.
Vogliate cortesemente contattare la locale rappresentanza.

1 Safety Instructions

1.1 Description conditions

a) High danger of health injury or loss of life



Danger

This symbol refers to high risk for persons to get health injury or loss life. It has to be followed strictly.

b) Risk of damage of machines



Caution

This symbol refers to informations, that, if ignored, could cause heavy mechanical damage. This warning has to be followed absolutely.

c) Note for proper function



Note

This symbol refers to an important information about proper use. If not followed, malfunction can be the result.

1.2 List of safety instructions

- Proper function of the Tension Measuring Amplifier is only guaranteed with the recommended application of the components. In case of other arrangement, heavy malfunction can be the result. Therefore, the installation instructions on the following pages must be followed strictly.
- Local installation regulations are to preserve safety of electric equipment. They are not taken into consideration by this operating manual. However, they have to be followed strictly.
- Improper handling may damage the fragile electronic equipment! Don't touch the electronic unit! Don't use rough tools as screwdrivers or pliers! Touch earthed metal part to discharge static electricity before touching the electronic unit!
- Bad earth connection may cause electric shock to persons, malfunction of the total system or damage of the electronic unit! It is vital to ensure that proper earth connection is done.

Table of Contents

1	Safety Instructions	2
1.1	Description conditions	2
1.2	List of safety instructions	2
2	Definitions	3
3	System components	4
3.1	Different EMGZ307 Variants	4
4	System Description.....	5
4.1	Functional description	5
4.2	Force sensors	5
4.3	Measuring amplifier EMGZ307	5
4.4	Block Diagram	6
5	Dimensions	7
6	Installation and Wiring	8
6.1	Mounting and Wiring of the Electronic Unit	8
6.2	Mounting the Force Sensors	8
6.3	Wiring	9
7	Setting into Operation	10
7.1	View of the Setting Elements	10
7.2	Settings for EMGZ307.582388	10
7.3	Configuring Gain and Offset	11
7.4	Configuring the Outputs	12
7.5	Configuring the Lowpass Filters	13
7.6	Calibrating the Measuring Amplifier	14
8	Trouble shooting.....	15
9	Technical Specification	15

2 Definitions

Offset:

Correction value for compensation of the zero point difference. Thanks to the offset, it is ensured that a force of 0N will generate a signal of 0V exactly.

Gain:

Amplification factor for the measuring signal. Use of proper value will set the measuring range of the sensor exactly corresponding to the signal output range (0...10V).

Strain gauge:

Electronic component that changes its resistance when its length changes. Strain gauges are used in the FMS force sensors for acquisition of the feedback value.

3 System Components

The EMGZ307 consists of the following components (refer also to fig. 1):

Force sensors

- For mechanical/electrical conversion of the tension force
- Force measuring bearing
- *Force measuring roller*
- *Force measuring journal*
- *Force measuring bearing block*

Measuring amplifier EMGZ307

- Hybrid module for supplying the force sensors and amplification of the mV signal
- Robust design with compact aluminium housing (IP67)
- Gain and offset alternatively configurable for infinitely or fixed adjustment
- Freely configurable lowpass filter
- Freely configurable outputs ($\pm 10V$; 0...20mA; 4...20mA)
- Supports connection of an external feedback display

(Components in italic letters indicate a variant or option)

3.1 Different EMGZ307 Variants

The tension measuring amplifier EMGZ307 is available in two variants:

EMGZ307: Standard 1-channel analogue amplifier

EMGZ307.582388: 1-channel analogue amplifier for rotating applications.
Electronics board is covered with moulding compound to secure the components and provide protection from centrifugal forces.



Note

This manual describes the possible setting of the standard amplifier EMGZ307. Some options, however, are not available in the EMGZ307.582388. For more details refer to chapter 7 “Setting into Operation”.

4 System Description

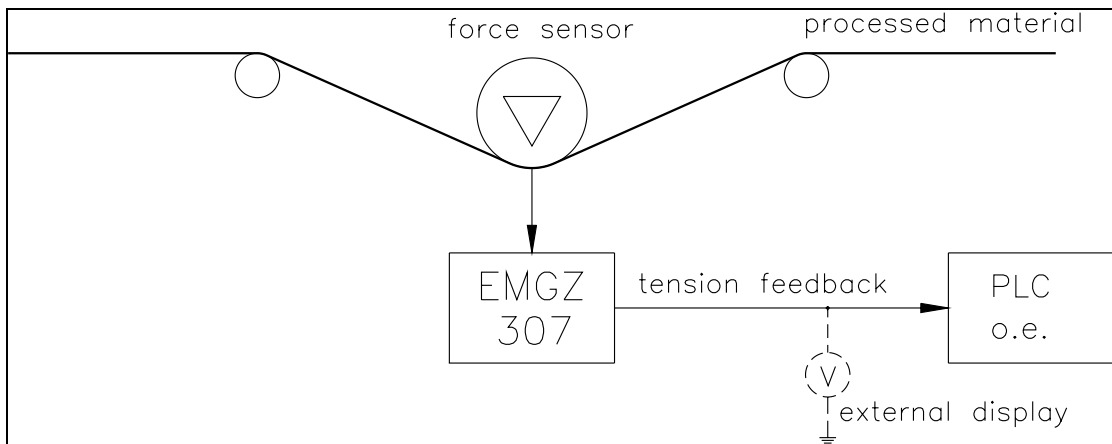

fig. 1: Basic structure of the EMGZ307 Tension Measuring Amplifier E307001e

4.1 Functional Description

The force sensors measure the tension force in the processed material and transmit the measuring value as a mV signal to the hybrid module in the measuring amplifier EMGZ307. The measuring amplifier amplifies the mV signal depending on configuration. The resulting feedback value can be transmitted to an analog instrument, a PLC or equivalent devices.

4.2 Force Sensors

The force sensors are based on the flexion beam principle. The flexion is measured by strain gauges and transmitted to the measuring amplifier as mV signal. Due to the wheatstone wiring of the strain gauges, the measured value is according also to the power supply. So, the force sensors are supplied from the EMGZ307 by a very accurate power supply.

4.3 Measuring Amplifier EMGZ307

The EMGZ307 is a single channel analog Tension Measuring Amplifier based on a hybrid circuit. It is developed specially for use under hard conditions. It is delivered in a sealed housing compliant with IP67. There can be connected 1 or 2 force sensors of 350Ω. The hybrid module provides the highly accurate 5V power supply and amplifies the mV signal of the force sensors to a level of 10V and 20mA. Tension and current output are active the same time. The hybrid technology ensures both good thermal and electrical characteristics. Measuring circuit and power supply are galvanic insulated. All settings are done alternatively by 2 trimmers or fixed by jumpers. For filtering of the signals, non-polarized capacitors can be soldered.

Infinite adjustment of gain and offset

Setting by trimmers is used to get a standardized output signal (for ex. 10V) from any kind of sensor signal. This ensures accurate amplifying of the signal and maximum immunity to any interference of the signal cable.

Fixed setting of gain and offset

Fixed setting is used when maximum thermal stability and vibration-proof conditions are needed. The signal is pre-amplified with a fixed value and has to be evaluated digitally (i.e. by PLC), so that offset and gain can be calculated.

4.4 Block Diagram

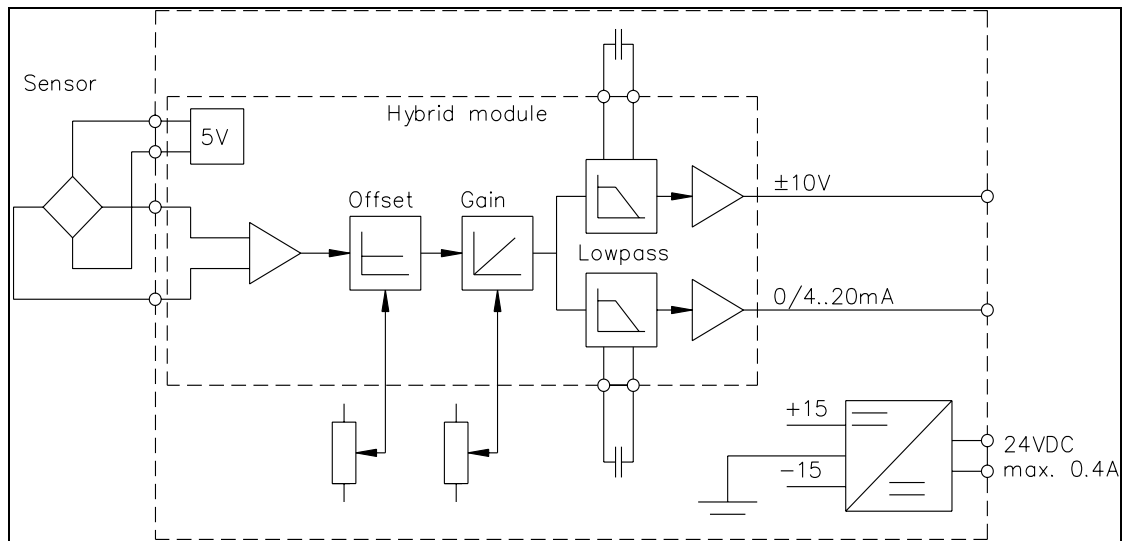

fig. 2: Block diagram

E307002e

5 Dimensions

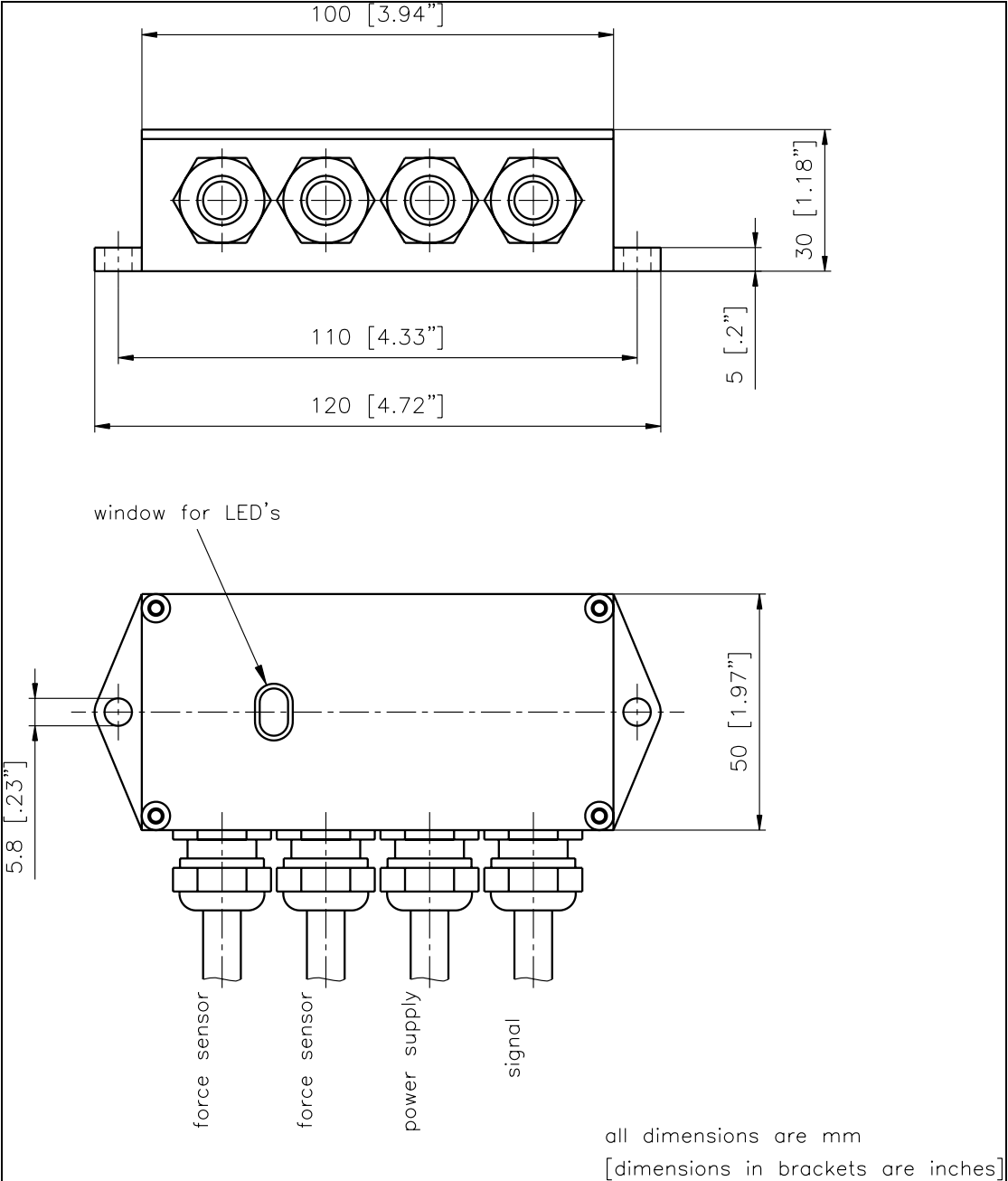

fig. 3: Outline drawing EMGZ307

E307003us

6 Installation and Wiring



Caution

Proper function of the Tension Measuring Amplifier is only guaranteed with the recommended application of the components. In case of other arrangement, heavy malfunction can be the result. Therefore, the installation instructions on the following pages must be followed strictly.



Caution

Local installation regulations are to preserve safety of electric equipment. They are not taken into consideration by this operating manual. However, they have to be followed strictly.

6.1 Mounting and Wiring of the Electronic Unit

The aluminium housing of the measuring amplifier may be mounted to any place in the machine, but usefully a position close to the force sensors is chosen. Wiring to the terminals is done according to wiring diagram (fig. 4).

6.2 Mounting the Force Sensors

Mounting of the force sensors is done referring to the FMS Installation manual which is delivered together with the force sensors.

Wiring to the terminals of the electronic unit is done according to wiring diagram (fig. 4).



Note

Connecting the shield of the signal cable to the electronic unit *and* to the force sensor may cause ground circuits which may interfere the measuring signal massively. Malfunction can be the result. The shield should be connected only to the electronic unit. On the „force sensor side“, the shield should stay open.

6.3 Wiring

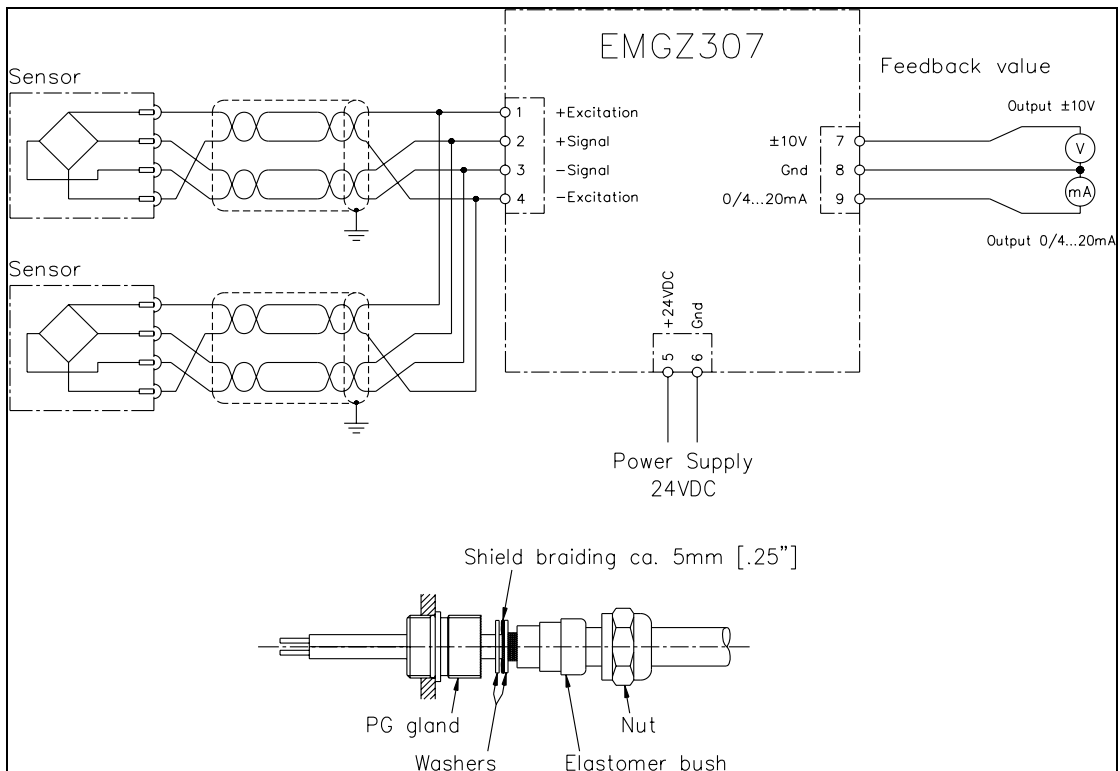



fig. 4: Wiring diagram

E307004e

There can be connected 1 or 2 force sensors to the measuring amplifier. Using 2 force sensors, the connections are internally wired parallel. The output signal of the measuring amplifier then will correspond to the average value of the 2 sensors. The connection between force sensors and measuring amplifier has to be done using $2 \times 2 \times 0.75 \text{ mm}^2$ [AWG 18] shielded twisted-pair cable. (With cable length below 15m, $2 \times 2 \times 0.25 \text{ mm}^2$ [AWG 23] is also suitable.) The cable must be installed separate from power lines.



Caution
Improper handling may damage the fragile electronic equipment! Don't touch the electronic unit! Don't use rough tools as screwdrivers or pliers! Touch earthed metal part to discharge static electricity before touching the electronic unit!



Caution
Bad earth connection may cause electric shock to persons, malfunction of the total system or damage of the electronic unit! It is vital to ensure that proper earth connection is done.



Note
The housing complies with IP67 only if no cable bushing stays open. Therefore, not needed PG glands have to be closed.

7 Setting into Operation

7.1 View of the Setting Elements

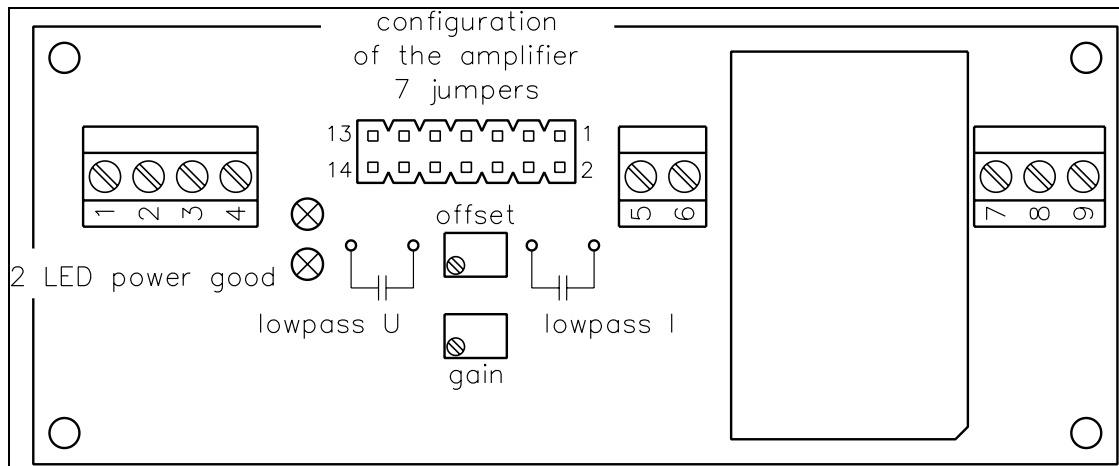

fig. 5: Wire terminals, switches EMGZ307

E307005e

7.2 Settings for EMGZ307.582388

The special type **EMGZ307.582338** for rotating applications has different setting options as the standard **EMGZ307**.

For the EMGZ307.582338 following differences exist:

- The offset is preset to “offset fix” see fig.7
- The gain is preset to “gain fix” = 1111 see fig. 7.
- The output current signal is preset to “4..20mA”, see fig. 9
- The electronics board of the amplifier is protected with moulding compound
- The unit is pre-assembled with cables of 8m length.

The wiring of the pre-assembled cables is described in the table below:

Cable Type	Terminal	Colour	Signal Name
Force sensor, 4 wire cable	1	yellow	+5V excitation
	2	white	+signal
	3	brown	-signal
	4	green	-5V excitation
Power supply, 2 wire cable	1	brown	+24V
	2	blue	GND
Signal, 3 wire cable	1	brown	0-10V
	2	black or yellow/green	GND
	3	blue	4-20mA

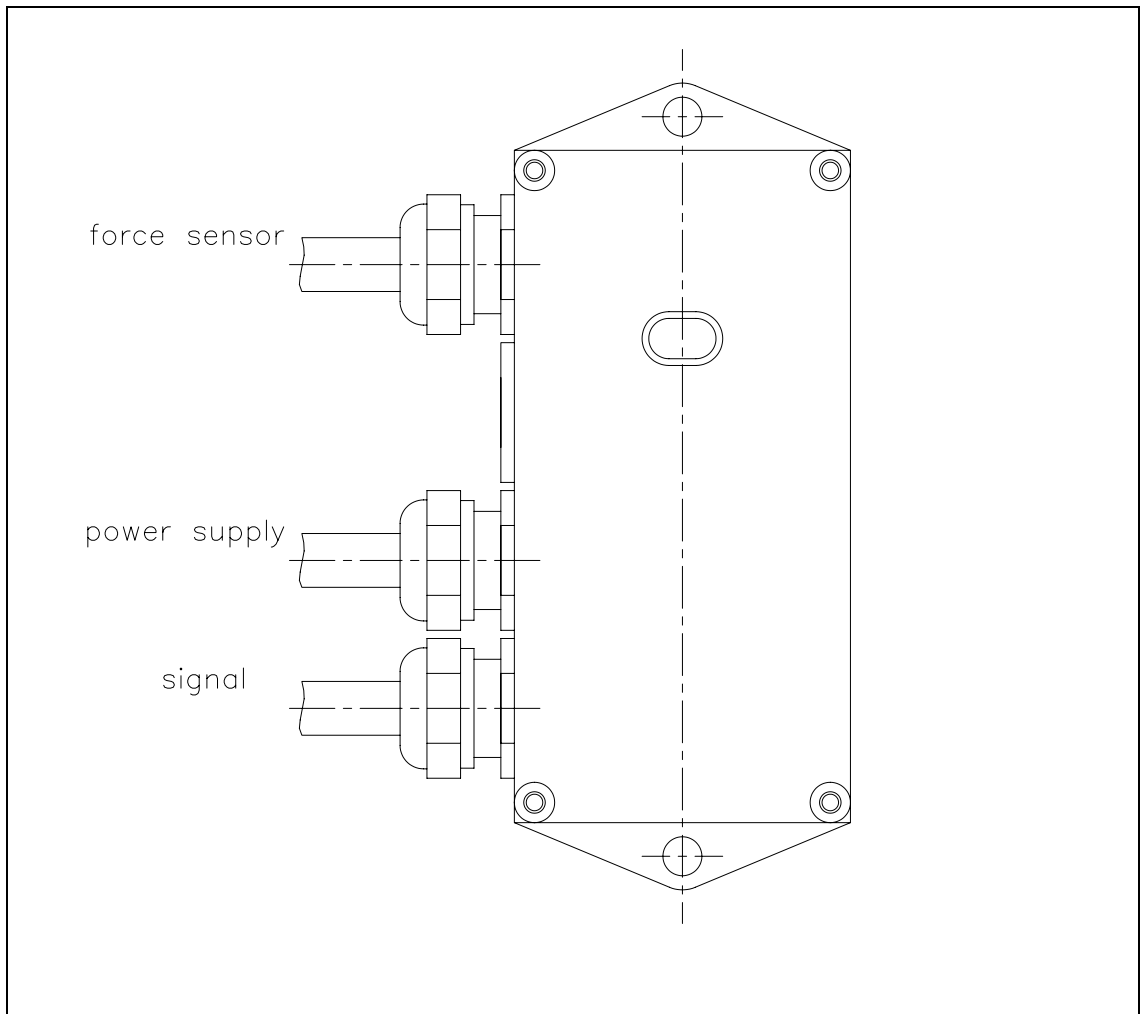

fig.6: Connections EMGZ307.582338

E307009e

7.3 Configuring Gain and Offset

Gain and offset are configured by jumpers. The settings can be made independently for gain and offset.

Gain and offset with infinite setting

If gain and offset are adjusted with the trimmers, the jumpers have to be set according to fig. 7. Gain and offset then may be adjusted using the trimmers (refer to „7.6 Calibration of the measuring amplifier“).

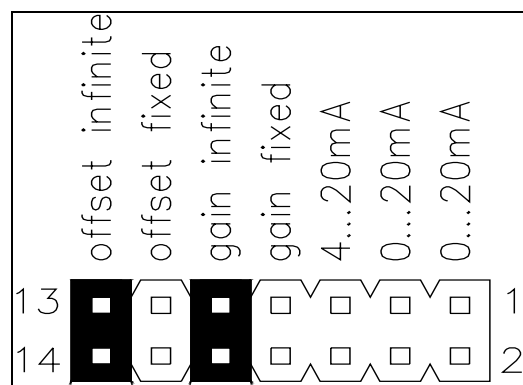

fig. 7: Jumper setting for infinite gain and offset adjustment

E307006ea

Gain and offset with fixed setting

If the signal is processed by a control unit (for ex. a PLC), configuration with fixed gain and offset is recommended (offset = 0; gain = 1111). Therefore, the jumpers have to be set according to fig. 8. With this configuration, the good thermal characteristics of the hybrid module are best utilized. The output signal will be 10V and 20mA when the nominal force of the sensor is applied.

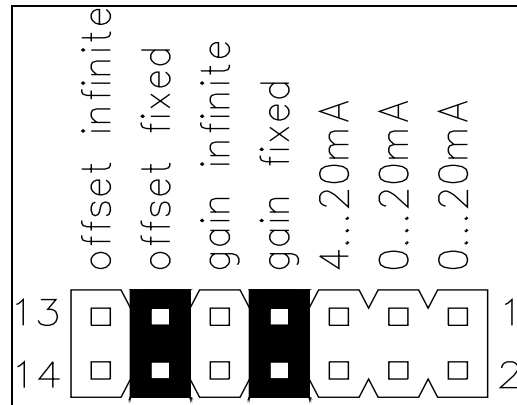

fig. 8: Jumper setting for fixed gain and offset E307006eb

7.4 Configuring the Outputs

The measuring amplifier provides a tension output ($\pm 10V$) and a current output (0...20mA or 4...20mA) which are active simultaneously. The signal of the current output is configured as follows:

Current output 0...20mA

The jumpers have to be set according to fig. 9a. This is the standard FMS factory setting.

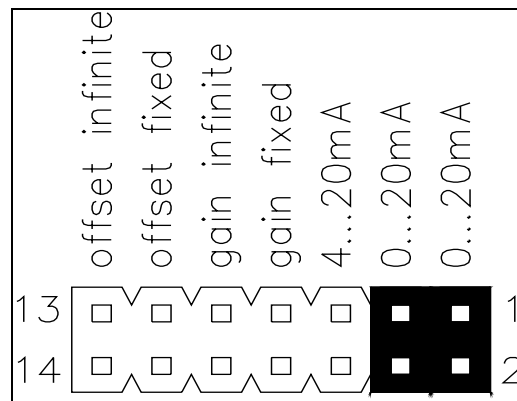

fig. 9a: Jumper setting for current output 0...20mA E307006ec

Current output 4...20mA

The jumpers have to be set according to fig. 9b.

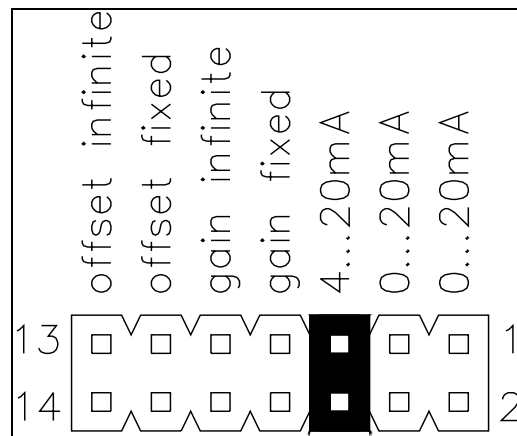

fig. 9b: Jumper setting for current output 4...20mA E307006ed

7.5 Configuring the Lowpass Filters

The measuring amplifier provides two lowpass filters. They are used to eliminate faulty signal variations which may be caused by unbalanced rollers, vibrations of the machine, or equivalent.

- The lowpass filter U is effective to the tension output.
- The lowpass filter I is effective to the current output.

The lower the cut-off frequency, the more sluggish the output signal will be. The configuration is made by soldering of a non-polarized capacitor to the soldering points (refer to fig. 5). The capacitor will be determined referring to the following formula or list:

$$C = 10 / F$$

C: Capacity [μ F]

F: Cut-off frequency [Hz]

Cut-off frequency [Hz]	Capacitor [μ F]
1	10
2	5
5	2
10	1
20	0.5
50	0.2
100	0.1
200	0.05
500	0.02
1000	0.01



Note

Don't use electrolytic capacitors because they can't handle the bipolar signals applied in this application. They would damage the electrolytic capacitor.

7.6 Calibrating the Measuring Amplifier

- Connect gauge to the tension or current output.
- Connect the first force sensor.
- Check if a positive output signal is appearing when loading the sensor in measuring direction. If not, exchange the two signal wires of the referring force sensor in the terminal block (terminals 2 / 3).
- If used, connect the second force sensor.
- Check if a positive output signal is appearing when loading the sensor in measuring direction. If not, exchange the two signal wires of the referring force sensor in the terminal block (terminals 2 / 3).
- Insert material or a rope loosely to the machine.
- Adjust the offset trimmer until the output value is zero.
- Load material or rope with a defined weight (fig. 10).
- Adjust the gain trimmer until the output value shows the needed value (for ex. 10V corresponding to 500N).

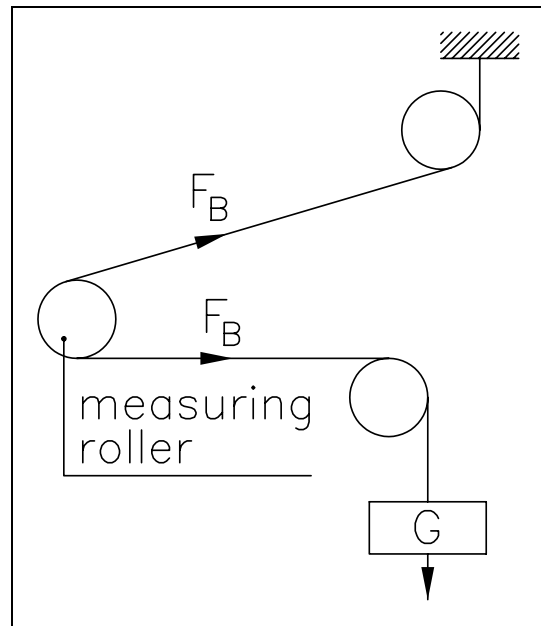

fig. 10: Calibrating the measuring amplifier C431011e



Note

If the measuring amplifier is operated with fixed gain and offset, signal conditioning has to be done with additional equipment (for ex. PLC).

8 Trouble shooting

Error	Cause	Corrective action
Output shows signal > 0 although material has no tension	Offset setting is bad	Readjust offset (refer to „7.5 Calibrating the measuring amplifier“)
	Current output is configured for 4...20mA	Change jumper setting if required
Output signal is not stable although material tension doesn't change	Cut-off frequency too high	Adjust cut-off frequency (refer to „7.4 Configuring the lowpass filter“)
	Ground terminal of the output isn't 0V	Connect Gnd terminal of the output (terminal 8) with earth
Adjusting the trimmers causes no result	Jumpers are not set to „infinite“	Set jumpers to „infinite“
Output shows no reaction, or 1 or 2 LED's don't light	Fuse blown	Replace fuse on power supply
	Power supply not correct	Check / correct power supply
	Measuring amplifier defect	Contact FMS customer service

9 Technical Specification

Sensor excitation	5VDC ± 20 ppm/K max. 30mA [± 11 ppm/ $^{\circ}$ F]
Gain factor range	fixed: 1111; variable: 500...5000
Offset range	fixed: 0mV; variable: ± 9 mV
Temperature drift offset	fixed: < 20ppm/K [11 ppm/ $^{\circ}$ F]; variable: ca. 50ppm/K [28 ppm/ $^{\circ}$ F]
Linearity error	< 0.1%
Tension output	± 10 V min. 1000 Ω
Current output	0/4...20mA max. 500 Ω
Lowpass cut-off frequency	adjustable, ca. 1...1000Hz
Power supply	24VDC (18...36VDC) max. 0.1A
Power consumption	max. 2.5W
Temperature range	-10...+60 $^{\circ}$ C [14 ... 140 $^{\circ}$ F]
Protection class	IP67



FMS Force Measuring Systems AG
Aspstrasse 6
8154 Oberglatt (Switzerland)
Tel. +41 44 852 80 80
Fax +41 44 850 60 06
info@fms-technology.com
www.fms-technology.com

FMS Italy
Via Baranzate 67
I-20026 Novate Milanese
Tel: +39 02 39487035
Fax: +39 02 39487035
fmsit@fms-technology.com

FMS USA, Inc.
2155 Stonington Ave. Suite 119
Hoffman Estates, IL 60169 USA
Tel. +1 847 519 4400
Fax +1 847 519 4401
fmsusa@fms-technology.com

FMS UK
Highfield, Atch Lench Road
Church Lench
Evesham WR11 4UG, Great Britain
Tel. +44 1386 871023
Fax +44 1386 871021
fmsuk@fms-technology.com